



User Manual

LP450 EK76
Air Cooled Marine
Nitrox Generator

Rev 08.18

If you have any questions on this equipment please contact Technical Support at:

Nuvair
1600 Beacon Place
Oxnard, CA 93033

Phone: +1 805 815 4044
Fax: +1 805 486 0900
Email: info@nuvair.com

Hours: Monday through Friday
8:00 AM to 5:00 PM PST USA

If you lose this manual, you can download the latest version at www.nuvair.com.

Warning

This User Manual contains important safety information and should always be available to those personnel operating this equipment. Read, understand, and retain all instructions before operating this equipment to prevent injury or equipment damage.

Every effort was made to ensure the accuracy of the information contained within. Nuvair, however, retains the right to modify its contents without notice. If you have problems or questions after reading the manual, stop and call Nuvair at +1 805 815 4044 for information.

LP450 EK76 Air Cooled Marine Nitrox Generator

Table of Contents

Introduction

1.0	Introduction	5
2.0	Safety Warnings.....	6
3.0	Safety and Operation Precautions	8
4.0	Legal Precautions	9
5.0	Theory of Operation	10
6.0	Low Pressure Rotary Screw Compressor Technical Data	11
7.0	System Components	12
8.0	Nitrox System Specifications	13
9.0	Nitrox Generator Component Identification.....	14
10.0	System Drawing/Schematic	16
11.0	System Flow Chart	17

Setup, Operation, and Maintenance

12.0	Preparing Existing HP Compressors.....	18
12.1	Purification System Air/Nitrox Quality	18
12.2	Replacement of Compressor Lubricant	18
12.3	Installation of Fill Oxygen Analyzer	19
13.0	Installing the Nitrox Generator.....	20
13.1	Precautions	20
13.2	Attaching Compressor Intake Hose	21
13.3	Attaching Nitrogen Discharge Hose (Optional)	21
13.4	Output Pressure Adjustments	22
13.5	Electrical Power Connection	23
13.6	Refrigerated Air Drier	24
13.7	Air/Nitrox Quality Testing	24
14.0	Pre-Operation Instructions	24
14.1	Compressor Lubricant Levels	25
14.2	Membrane System O ₂ % Control and Flow Valve	25
14.3	Oxygen Analyzer Calibration	26
14.4	Filling SCUBA Cylinder	27
15.0	Producing Nitrox	28
15.1	Flow to Membrane.....	28
15.2	Setting Proper Pressure	29
15.3	Final Adjustments Before Pumping Nitrox	30
15.4	Pumping Nitrox	30
15.5	Shutting Down	33
16.0	Nitrox Operation Notes	34
16.1	Correlation of Input (Feed) Air Pressure to Oxygen Content.....	34
16.2	Hot Fills	34
17.0	Maintenance	35
17.1	Daily Maintenance	35
17.2	Routine Maintenance	35
17.3	Compressor Lubricant	37
17.4	LP Filtration Inspection and Changing.....	39
17.5	Spare Parts List	40
17.6	Service Record Log	41
Appendix	42
	Supply and Breathing Air Specifications	42
	Filter Element Life Factors	42
	Owner's Warranty Responsibilities	43
	Warranty	44
	Additional Records of Change	45

Separate Manuals Supplied:

Nuvair Pro O₂ Oxygen Analyzer User Manual

1.0 Introduction

Nuvair has taken extreme care in providing you with the information you will need to operate this system. However, it is up to you to carefully read this manual and make the appropriate decisions about system safety.

This manual will assist you in the proper set-up, operation and maintenance of the Nuvair LP450 Nitrox Generator. Be sure to read the entire manual.

Throughout this manual we will use certain words and symbols to call your attention to conditions, practices, and / or techniques that may directly affect your safety. Pay particular attention to information introduced by the following signal words:

Danger

Indicates an imminently hazardous situation, which if not avoided, will result in serious personal injury or death.

Warning

Indicates a potentially hazardous situation which, if not avoided, could result in serious personal injury or death.

Caution

Indicates a potentially hazardous situation, which, if not avoided, may result in minor or moderate injury. It may also be used to alert against unsafe practices.

Notice

Notifies people of installation, operation or maintenance information which is important but not hazard-related.

2.0 Safety Warnings

 **Warning**

This equipment is used to provide breathing gas for the purpose of underwater life support. Read this manual in its entirety. Failure to heed the warnings and cautions contained in this document may result in severe injury or death.

 **Warning**

The equipment you will be using to manufacture nitrox (oxygen rich air) will expose you to both low and high-pressure gas. Gas, even under moderate pressures, can cause extreme bodily harm. Never allow any gas stream to be directed at any part of your body.

 **Warning**

Any pressurized hose can cause extreme harm if it comes loose or separates from its restraint (or termination) while under pressure and strikes any part of your body. Use appropriate care in making and handling all gas connections.



 **Danger**

Pure nitrogen is a colorless, odorless, tasteless gas that will not support life. Breathing gas mixtures containing more than 84% nitrogen at surface pressures will lead to unconsciousness and may cause death.

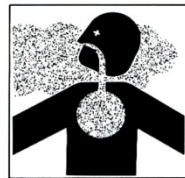

 **Warning**

The nitrogen discharge from the membrane system must be vented to the exterior of any closed building, boat, or similar enclosed space. Breathing gas mixtures containing more than 84% nitrogen at surface pressure will lead to unconsciousness and may cause death.



 **Warning**

Do not use any form of mineral oil or synthetic lubricant not rated for nitrox in any compressor in this system. Use only the recommended nitrox compressor lubricant. Never mix the nitrox compressor lubricant with other lubricants. Remove all existing lubricant and replace with the proper nitrox compressor lubricant prior to installing the membrane system. The use of improper lubricants can lead to fire or explosions, which may cause serious personal injury or death.



 **Warning**

Do not use this system to produce nitrox mixtures containing more than 40% oxygen. Pumping nitrox mixtures with higher concentrations of oxygen may lead to fires or explosions, which can cause serious personal injury or death.

Warning

The use of enriched air nitrox does not eliminate the risk of decompression sickness (DCS) in diving. Decompression sickness can lead to permanent disability or death.



Warning

Do not pump nitrox mixtures at pressures above the HP compressor manufacturer's rating, and never above 3600 psi (250 bar). Higher pressures may lead to explosions which may cause serious personal injury or death.

Caution

Ambient room temperature should never exceed 104° F (40° C) during operation of the nitrox system. Operation at higher temperatures may lead to system damage and malfunction. A damaged membrane will not produce the correct nitrox mixture which can lead to severe personal injury if the gas is used for diving purposes without proper analysis.

Warnings Graphics Defined:



Moving belts



Electrocution

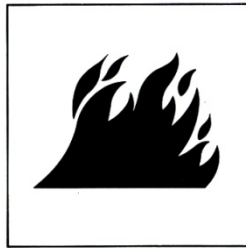

Fire

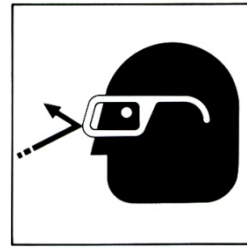

Eye protection



Gas inhalation



Skin damage

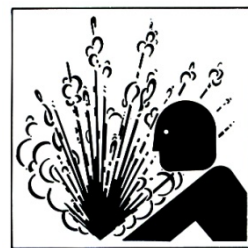

Explosion



Explosion



Electrocution

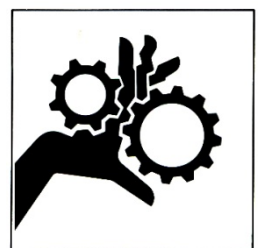

Machinery

Abbreviations commonly used in this manual:

psi Pounds per Square Inch
 HP High Pressure
 LP Low Pressure
 O₂ Oxygen
 CO Carbon Monoxide
 CO₂ Carbon Dioxide
 N₂ Nitrogen

C.F.M. Cubic Feet per Minute
 R.P.M. Rotations per Minute
 P.P.M. Parts per Million
 L/min Liters per Minute
 O₂% Oxygen Percentage of Gas
 B.P. Back Pressure

Cubic Feet per Minute
 Rotations per Minute
 Parts per Million
 Liters per Minute
 Oxygen Percentage of Gas
 Back Pressure

3.0 Safety And Operation Precautions

Because a compressor is a piece of machinery with moving and rotating parts, the same precautions should be observed as with any piece of machinery of this type where carelessness in operations or maintenance is hazardous to personnel. In addition to the many obvious safety precautions, those listed below must also be observed:

- 1) Read all instructions completely before operating any compressor or nitrox system.
- 2) For installation, follow all local electrical and safety codes, as well as the National Electrical Code (NEC) and the Occupational Safety and Health Administration (OSHA) standards.
- 3) Electric motors must be securely and adequately grounded. This can be accomplished by wiring with a grounded, metal-clad raceway system to the compressor starter; by using a separate ground wire connected to the bare metal of the motor frame; or other suitable means.
- 4) Protect all power cables from coming in contact with sharp objects. Do not kink power cables and never allow the cables to come in contact with oil, grease, hot surfaces, or chemicals.
- 5) Make certain that power source conforms to the requirements of your equipment.
- 6) Pull main electrical disconnect switch and disconnect any separate control lines, if used, before attempting to work or perform maintenance. "Tag Out" **and** "Lock Out" all power sources.
- 7) Do not attempt to remove any parts without first relieving the entire system of pressure.
- 8) Do not attempt to service any part while system is in an operational mode.
- 9) Do not operate the system at pressures in excess of its rating.
- 10) Do not operate compressor at speeds in excess of its rating.
- 11) Periodically check all safety devices for proper operation. Do not change pressure setting or restrict operation in any way.
- 12) Be sure no tools, rags or loose parts are left on the nitrox generator.
- 13) Do not use flammable solvents for cleaning the air inlet filters or elements and other parts.
- 14) Exercise cleanliness during maintenance and when making repairs. Keep dirt away from parts by covering parts and exposed openings with clean cloth or Kraft paper.
- 15) Do not operate the compressor without guards, shields, and screens in place.
- 16) Do not install a shut-off valve in the compressor discharge line, unless a pressure relief valve, of proper design and size, is installed in the line between the compressor unit and shut-off valve.
- 17) Do not operate this compressor in any location where there is a possibility of toxic levels of carbon monoxide (CO), carbon dioxide (CO₂), nitrogen (N), or any flammable or toxic fumes being sucked into the compressor intake.
- 18) Be careful when touching the exterior of a recently run electric, gasoline, or diesel motor - it may be hot enough to be painful or cause injury. With modern motors this condition is normal if operated at rated load - modern motors are built to operate at higher temperatures.
- 19) Inspect unit daily to observe and correct any unsafe operating conditions found.
- 20) Do not "play around" with compressed air, or direct air stream at body, because this can cause injuries.
- 21) Compressed air from this machine absolutely must not be used for food processing or breathing air without adequate downstream filters, purifiers and controls and periodic air quality testing.
- 22) Always use an air pressure-regulating device at the point of use, and do not use air pressure greater than marked maximum pressure.
- 23) Check hoses for weak or worn conditions before each use and make certain that all connections are secure.

The user of any compressor or nitrox system manufactured by Nuvair is hereby warned that failure to follow the preceding Safety and Operation Precautions can result in injuries or equipment damage. However, Nuvair does not state as fact or does not mean to imply that the preceding list of Safety and Operation Precautions is all-inclusive, and further that the observance of this list will prevent all injuries or equipment damage.

4.0 Legal Precautions

It is highly recommended that a nitrox fill log be maintained when filling SCUBA cylinders to document the following information. This log must be of permanent binding style with no loose pages.

- Fill date and time of day
- Tank serial number
- Supplier's check of oxygen content O₂% plus signature and date
- User's check of oxygen content O₂% plus signature and date
- Fill pressure
- MOD (maximum operating depth) in user's handwriting
- Nitrox certifying agency and card number

5.0 Theory of Operation

The LP450 Nitrox Generator system is a system that produces oxygen-rich air (nitrox) ready for delivery to a High Pressure (HP) compressor to fill SCUBA tanks or storage cylinders. The package is designed to be fully automatic with an operator overseeing the production to maintain proper nitrox mixtures not to exceed 40% oxygen. Although it is described as the “nitrox compressor”, it can also be used to pump air.

The nitrox system allows for efficient and cost effective nitrox production using electric power, without the hazards or expense of blending with stored high-pressure oxygen (O₂). Instead, the system uses a semi-permeable membrane to produce nitrox from air. A portion of the nitrogen in air is separated out, leaving an oxygen rich nitrox mixture.

The LP450 Nitrox Generator TM uses a rotary screw LP compressor, air / oil aftercooler, (optional) refrigerated air dryer, and filtration to provide the membrane system with a source of clean, pressurized feed air for separation. The air is filtered to CGA Grade D or better air quality prior to entering the membrane system so it will not damage or plug the membrane fibers. Specifications for Grade D air are provided in the appendix.

The LP450 Nitrox Generator membrane system is rated for a maximum feed air pressure of 300 psi (21 bar) and has been configured to work well with the 175 psi (12 bar) maximum pressure delivered by the LP compressor. A back-pressure regulator is used to adjust the amount of air the screw compressor produces to meet the appropriate levels for various O₂% nitrox production. The air is then heated to a temperature that provides stability over a wide range of ambient conditions, is optimal for membrane permeation, and prevents moisture condensation.

The heated air enters the membrane, which is made up of thousands of miniature hollow fibers. The walls of these fibers are semi-permeable and designed for different gases to move through them (or permeate) at different speeds. The resulting gas mixture is known as the “permeate.” As air flows through the hollow fibers, both oxygen and nitrogen permeate through the fiber walls. The oxygen permeates faster than the nitrogen, which produces permeate with oxygen content greater than air. The gas that reaches the end of the hollow fibers without permeating is almost entirely nitrogen and is discharged. The flow rate of this discharge is set by the factory via a fixed orifice, which controls the permeate.

The permeate is a concentrated mixture that is diluted with air prior to entering the HP compressor. It exits the membrane at ambient to slightly negative pressure and travels into the mixing tube, where it mixes homogeneously with filtered outside air. The amount of dilution, and thus final O₂%, is obtained by adjusting the amount of air produced by the compressor and supplied to the membrane, with the back pressure regulator. As air flow to the membrane is increased, permeate flow increases and a higher O₂% nitrox is produced. As air flow to the membrane is decreased, permeate flow decreases, compressor intake air increases, and a lower O₂% nitrox is produced.

This relationship between permeate flow and intake air flow exists because the total of these two flow rates will always equal the intake flow rate demanded by the HP compressor. The resulting nitrox mixture is analyzed for O₂% before entering the HP compressor for approximate content and again when pumping nitrox for precise content. The HP compressor pumps the nitrox to a maximum pressure of 3600 psi (250 bar) to fill SCUBA tanks or storage cylinders.

A unique feature of NuVair nitrox systems is that the feed air pressure that correlates to a specific nitrox O₂% is repeatable. For example, if your HP compressor pumps 36% O₂ when the feed air pressure is at 125 psi (9 bar), then adjusting the back pressure regulator to 125 psi (9 bar) during the next use will produce the same mixture.

6.0 Low Pressure Rotary Screw Compressor Technical Data

EK76

- Capacity and Power Consumption
 - Normal operating pressure 100-175 psi (7-12 bar)
 - Capacity at 175 psi 46 CFM (1303 L/min)
 - Maximum operating pressure of system 175 psi (12 bar)
 - Minimum operating pressure 73 psi (5 bar)
 - Transmission Belt drive
- Cooling
 - Allowed ambient temperature 32-104°F (0-40°C)
- Motor and electrical values
 - Motor - F class, IP55 15 hp (11.2 kW)
 - Compressor current
 - 208-230 V / E3 / 60 Hz 47 A
 - 380-415 V / E3 / 50 Hz 22 A
 - 440-480 V / E3 / 60 Hz 21 A
 - Control voltage 230 V
- General technical data
 - Oil Quantity 4 liters
 - Oil Content 3 mg/m³

 **Notice**

Rotary screw compressors are continuous duty rated. They are not made to run for short intervals or sit without use for long periods of time. The rotary screw compressor must be run for a minimum of one continuous hour per week in tropical settings to insure moisture does not build up in the compressor. The oil filter, pre-filter and oil/air separator must be changed every 2000 hours or a minimum of once per year. In tropical conditions the oil should be checked every month for moisture by draining a small amount off the bottom of the compressor into a clear glass. If moisture is found it can be drained off and a visual inspection should be done on all filters checking for rust or corrosion.

7.0 System Components

- Low Pressure Rotary Screw Compressor
- Refrigerated Air Dyer
- Nuvair 546™ Food Grade Rotary Screw Compressor Lubricant
- On/Off Flow (Feed) Air Valve
- LP Compressor Output Regulator with Pressure Gauge:
- Adjusted Pressure Output 90-175 psi (6-12 bar) depending on nitrox O₂%
- Low Pressure Filtration, Grade D Breathing Air, including three stages:
 - Coalescing & Particle Removal to 1 micron, auto drain, differential pressure indicator
 - Water & Oil Vapor Removal to 0.01 micron, auto drain, differential pressure indicator
 - Oil Vapor Removal to 0.003 PPM, manual drain
- Heater including:
 - Thermostat Control
 - Digital Temperature Gauge
 - Pressure Switch
- Semi-Permeable Membrane – compatible with HP compressors rated up to 10 CFM (283 L/min)
 - FAD for 40% O₂ 16 CFM (450 L/min)
 - FAD for 36% O₂ 20 CFM (566 L/min)
 - FAD for 32% O₂ 27.5 CFM (780 L/min)
- Mixing Tube & Air Intake Filter
- Nuvair Pro O₂ Remote™ Panel Mount Inline Oxygen Analyzer
- Compressor Intake Hose for nitrox Compressor
- Nitrogen Discharge Hose (optional)
- Nuvair Pro O₂™ Fill Oxygen Analyzer, including:
 - High Pressure>Low Pressure Regulator
 - Flow Restrictor, 1 - 5 L/min
- Nitrox Compressor Lubricant:
 - Nuvair 455™ Food Grade Lubricant (standard)
 - Nuvair 751™ Diester Based Lubricant (optional)
- Air/Nitrox Quality Analysis Kit

8.0 Nitrox System Specifications

Nuvair Nitrox Generator Model		LP450
Physical Specifications	Height	46 in (117 cm)
	Width	56 in (142 cm)
	Length	38 in (97 cm)
	Weight	671 lb (304 kg)
Electrical Specifications	Full Load Amps System 440-480 V / E3 / 60 Hz 380-415 V / E3 / 50 Hz 208-230 V / E3 / 60 Hz	21 A 22 A 47 A
Membrane Input	Operating Pressure Range	100-175 psi (7-12 bar)
	Maximum Input Pressure	300 psi (21 bar)
	Supply Air Volume Range	10-44 SCFM (238-1246 L/min)
	LP Supply Air Quality	Grade D
	Optimum Temperature	110 +/- 5°F (43 +/- 3°C)
	Nitrox O₂% Range	24 - 40%

9.0 Component Identification

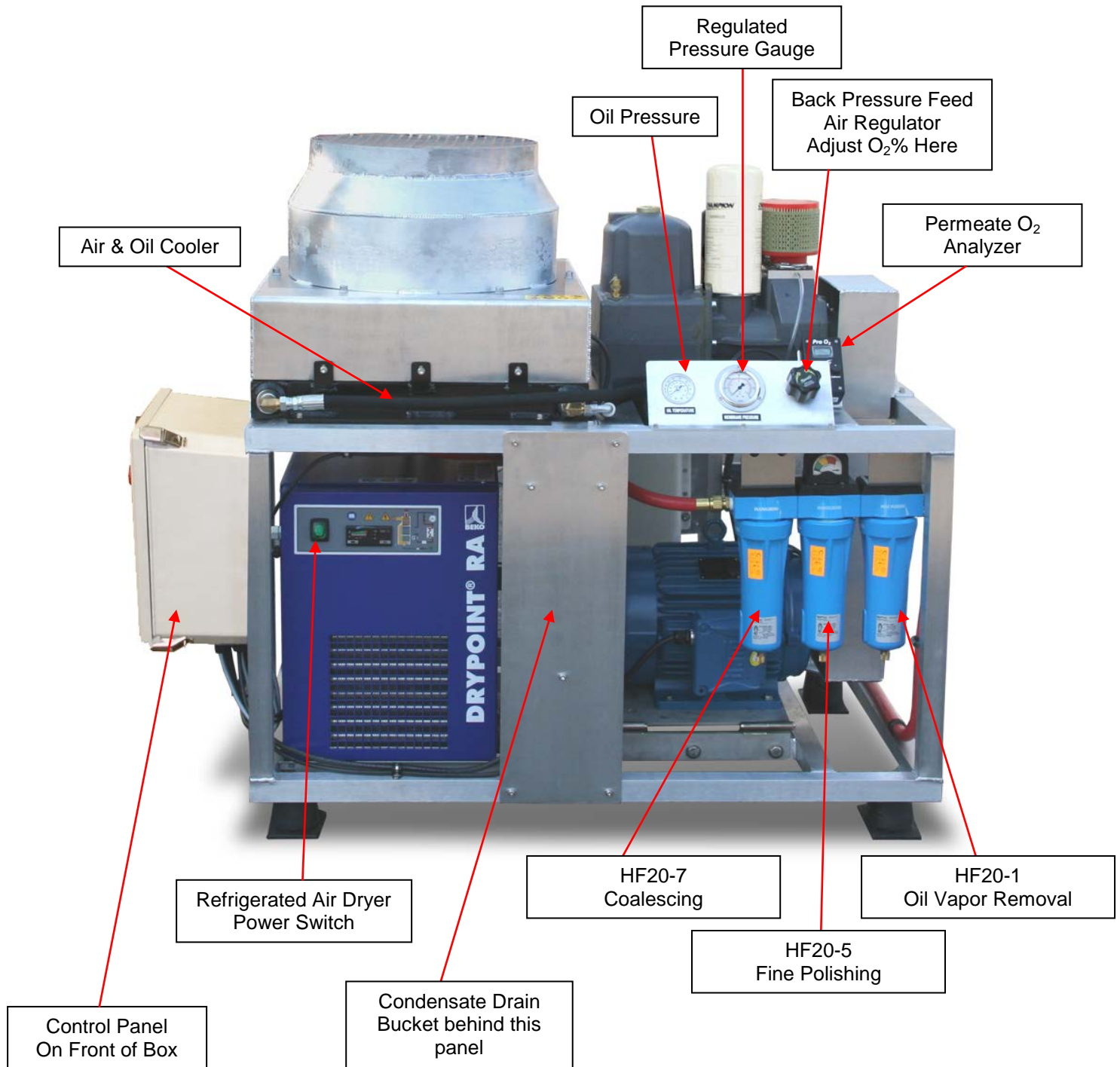

LP450 EK76 Air Cooled Marine Nitrox Generator

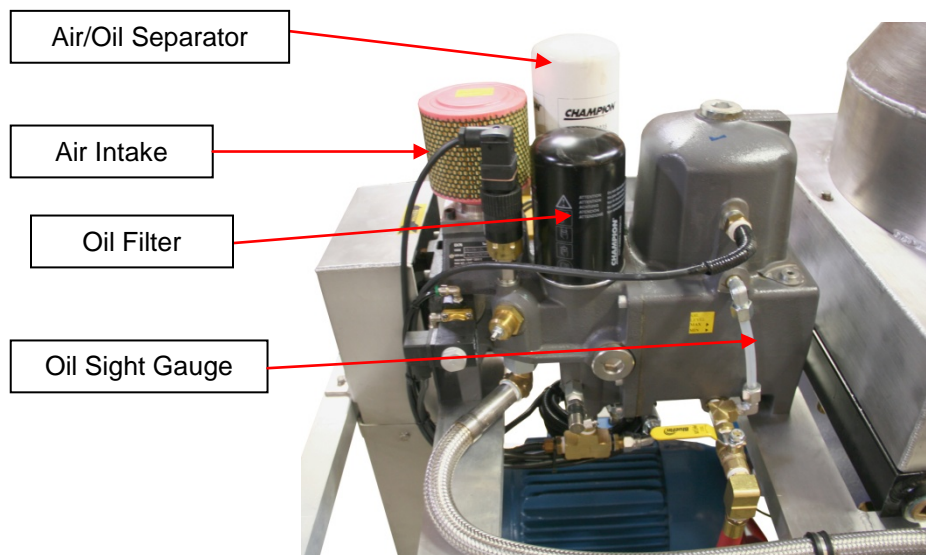
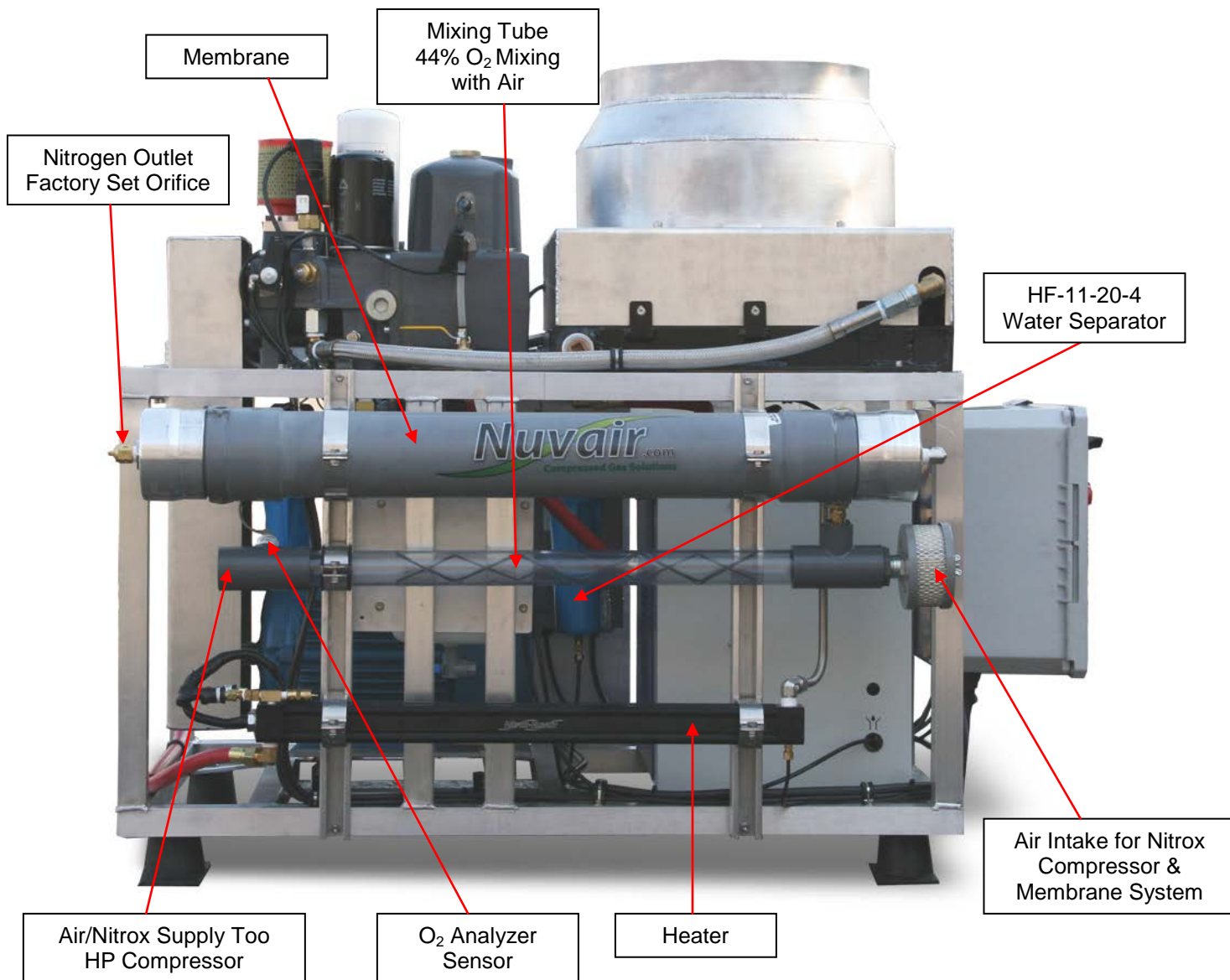

10.0 System Drawing / Schematic

LP450 Nitrox Generator
System Components Shown
Within Dashed Lines

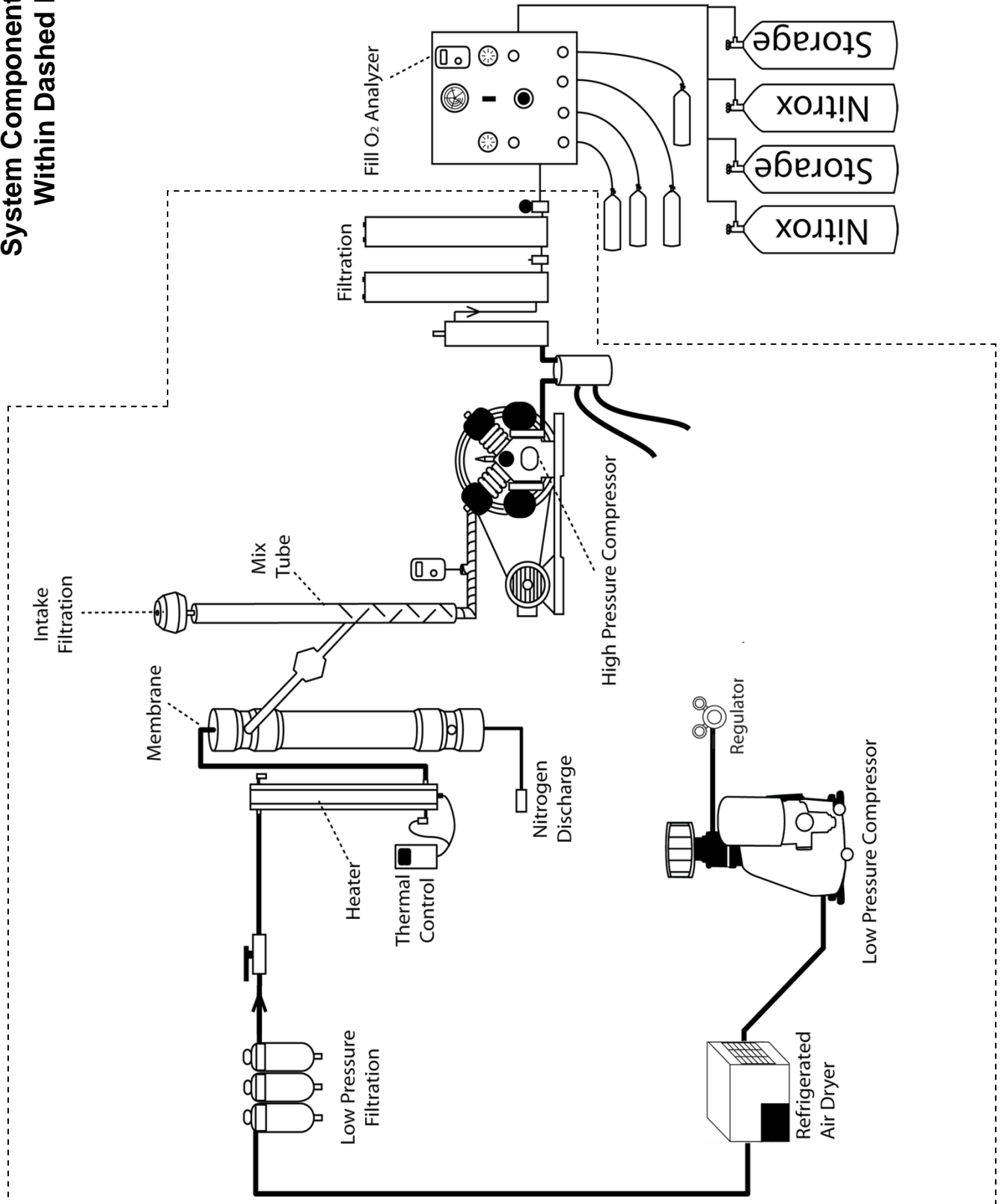

11.0 System Flow Chart

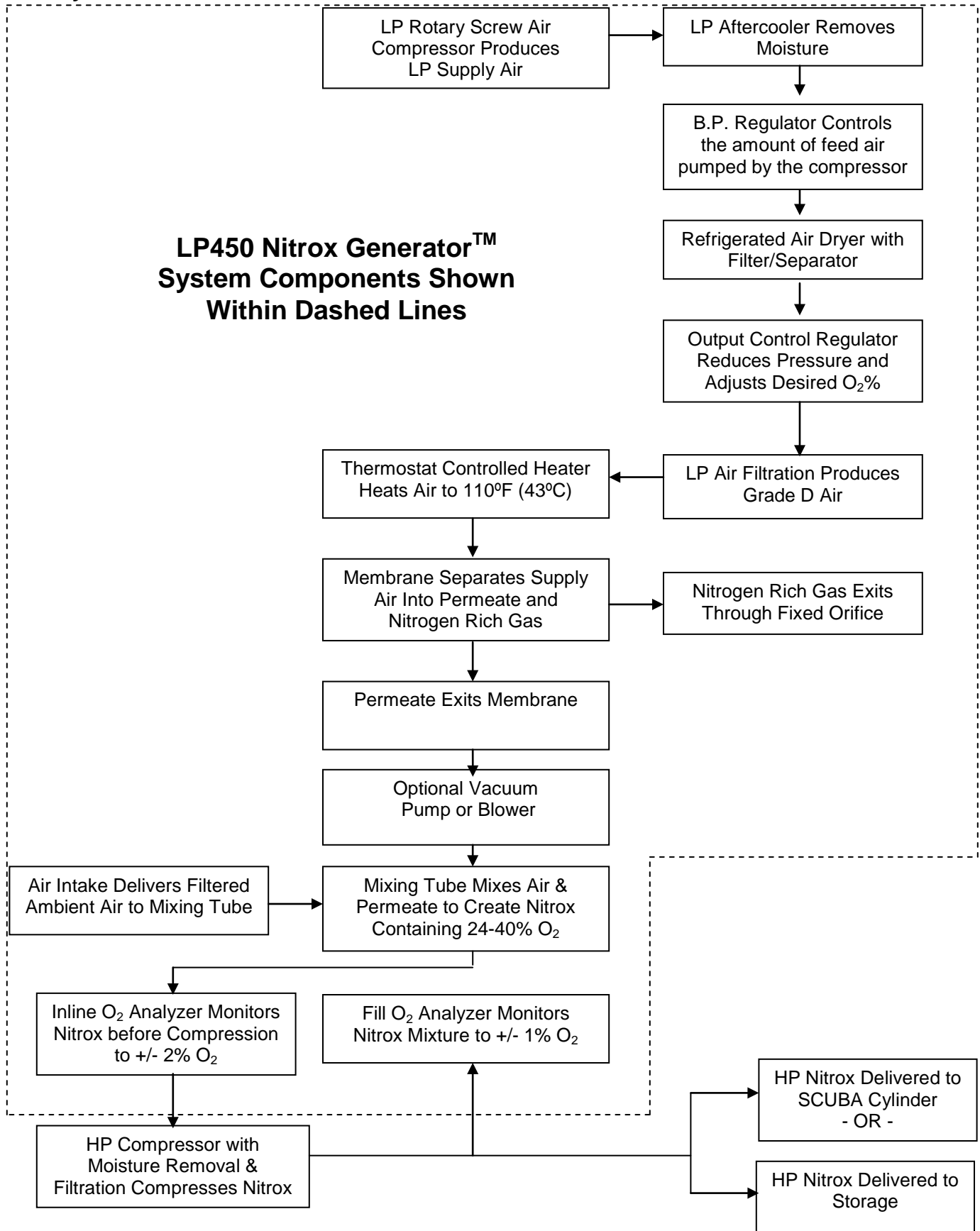

12.0 Preparing Existing HP Compressors



Warning

Some compressors are not suitable for compressing oxygen-rich air, i.e., nitrox. Use of an unsuitable compressor may lead to possible compressor damage and/or fires or explosion. This can lead to serious personal injury or death. If there is any doubt regarding the use of an existing compressor, contact Nuvair or the compressor manufacturer before you connect your nitrox system to your machinery.

12.1 Purification System

The purification system on the existing HP compressor to which the nitrox system will be installed must produce Grade E, DIN 3188, EN 12021, CGA E and CSA breathing air appropriate for diving use. This is the same standard applied to all breathing air compressors. Please make sure you place extra caution on timely replacement of the filters in the purification system to ensure these standards at all times. Specifications for Grade E air, DIN 3188, EN 12021, CGA E and CSA are provided in the appendix.

A recent air quality test from your existing compressor is highly recommended prior to installing the nitrox system. After installation, test a nitrox sample using the air/nitrox quality analysis kit provided. Quarterly testing is mandatory once the system is operational.



Caution

Breathing air compressors must produce breathing air appropriate for diving use in accordance with the appropriate CGA Grade. Periodic air quality testing is mandatory to assure compliance.

12.2 Replacement of High Pressure Compressor Lubricant

For an existing compressor to be used with the membrane system, all traces of old lubricant must be removed and replaced with nitrox compressor lubricant. nitrox compressor lubricant is compatible with both air and nitrox.

- 1) Start compressor and run for 10 minutes to warm compressor lubricant. Shut off compressor, remove lubricant, and replace lubricant filter if any.
- 2) Refill compressor with the Nuvair air/nitrox compressor lubricant supplied. Do not overfill.
- 3) After 10 hours, repeat Steps 1 and 2.



Nuvair™ 455
Premium Synthetic
Food Grade Air/nitrox
Compressor



Nuvair™ 751
Premium Synthetic
Diester Based
Air/nitrox Compressor



Warning

Any oil spilled during the oil and oil filter change could cause personnel to slip and fall. Wear anti-slip footwear. Remove any traces of spilled oil immediately. Slips and falls may cause severe personal injury or death.



Warning

Do not carry out any maintenance tasks if the compressor has just shut down. Wait for the compressor to cool to avoid skin burns.

Notice

Recommended nitrox compressor lubricant change intervals after the 10-hour flush are at 25, 50, and 100 hours. After reaching 100 hrs, change lubricant in 100 hour cycles.

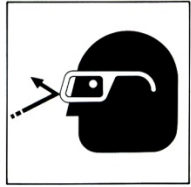

Caution

Wear eye protection, gloves, and skin protection when performing oil changes. Although the oil is not classified as a dangerous substance, the oil can be irritating to your eyes and skin.



Warning

Use only the specified Nuair lubricants in this system. The use of incompatible lubricants presents a risk of fire and/or explosion, and may result in system damage. This can lead to severe personal injury or death.



Caution

Both oil and oil filter are classified as “special wastes” and must be disposed of properly according to applicable national and local laws. Failure to dispose of these wastes properly can lead to death of wildlife as well as government fines and penalties.

12.3 Installation of Fill Oxygen Analyzer

The fill oxygen analyzer is installed at the final nitrox outlet (compressor fill whip, fill panel, etc.) to monitor oxygen content. A sample stream of nitrox is delivered to the analyzer to provide accurate results and prevent damage to the analyzer. A regulator and flow restrictor are used to control the pressure and flow of the sample stream. After installation, always use the fill oxygen analyzer when pumping either nitrox or air to ensure proper oxygen content.

Warning

Never expose the oxygen analyzer sensor to pressures other than ambient or you may damage it and/or cause false readings. A damaged sensor will not provide accurate gas analysis. Inaccurate gas analysis can lead to serious personal injury or death when the gas mixture that was analyzed is used for breathing.

LP450 EK76 Air Cooled Marine Nitrox Generator

The nitrox sample stream is obtained at the fill whip location on the compressor or fill panel. Tap into the fill whip manifold or install a HP “T” fitting, then attach the inlet of the regulator/flow restrictor assembly using HP hose and fittings as required (hose and fittings not included). Mount the fill oxygen analyzer in a secure location, and then attach the outlet of the regulator/flow restrictor assembly to the analyzer using the hose provided.



13.0 Installing the Nitrox System

Notice

If any information in these manual conflicts with any of the other manuals provided, call our headquarters at 1-805-815-4044 before proceeding.

13.1 Precautions

- 1) Please read all information supplied before physically installing the nitrox system.
- 2) Unpack the system and remove from the pallet. Visually inspect the system to make sure there has been no damage during shipping. If damaged, please call Nuvair to file a damage report. Please take photos and supply detailed information about the damage.
- 3) Place the system in a permanent location near the existing HP compressor. Allow a minimum spacing of 18 inches from adjacent walls. Select a location where ambient room temperature will never exceed 104°F (40°C).
- 4) The Heater Thermostat has been set in the factory. Do not adjust.
- 5) A 13 foot corrugated compressor intake hose has been provided to connect the nitrox system to the HP Compressor intake. If a longer hose is required, the diameter must also be increased. Contact Nuvair for assistance.

Caution

Do not use a compressor Intake hose longer than 13 feet to connect the nitrox generator to the compressor intake. Use of a longer hose will increase the amount of suction the compressor must generate which can cause overheating and damage to the compressor. Damaged compressors can pump impurities into the diver's breathing gas.

Caution

Do not substitute a compressor intake hose of a smaller diameter than the supplied by Nuvair. Use of a smaller diameter hose will increase the amount of suction the compressor must generate which can cause overheating and damage to the compressor. Damaged compressors can pump impurities into the diver's breathing gas.

13.2 Attaching Compressor Intake Hose

- 1) Only use the corrugated compressor intake hose provided with the nitrox generator. If a longer hose is required, contact Nuvair for assistance.
- 2) Cut the intake hose to proper length to reach between the nitrox generator and HP compressor. Reattach the end fittings
- 3) Attach the Intake Hose to the membrane system outlet.
- 4) Attach the other end of the Intake hose to the intake of the HP compressor and secure with the hose clamp provided.

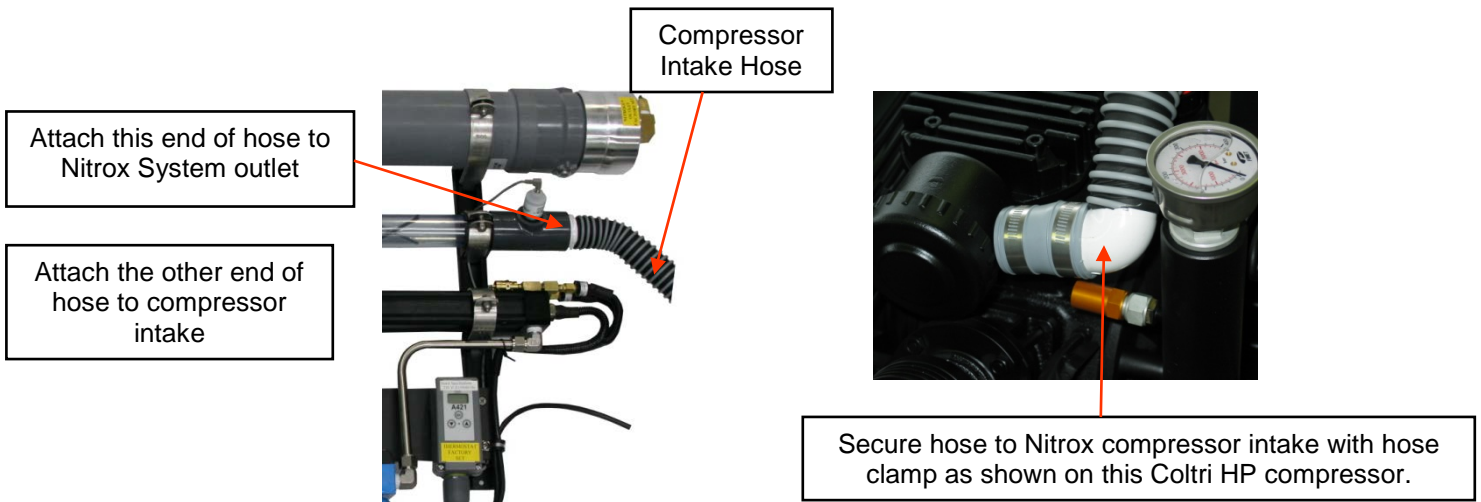

13.3 Attaching Nitrogen Discharge Hose (Optional)

The nitrogen discharge from the membrane must be isolated from the air intakes of the membrane system and LP compressor. This requirement will be met if the nitrox system is installed in a well-ventilated room that meets industry standards for compressor installations. If the nitrox generator is installed in a closed building, boat, or similar enclosed space, the nitrogen discharge must be vented to the outside. An optional nitrogen discharge hose may be needed. If your installation requires the use of a nitrogen discharge hose, please contact Nuvair for assistance.

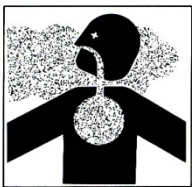

Warning

Pure nitrogen is a colorless, odorless, tasteless gas that will not support life. Breathing gas mixtures containing more than 84% nitrogen at surface pressures will lead to unconsciousness and may cause death.

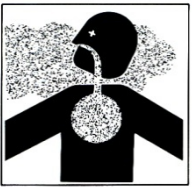

Warning

The nitrogen discharge from the membrane should be vented to a well-ventilated room or to open air with good circulation. Failure to isolate the discharge from the air intake of the membrane system or LP compressor could lead to incorrect nitrox mixtures, resulting in serious personal injury or death. If you allow this pure nitrogen to accumulate in an enclosed space, anyone entering this space will quickly lose consciousness and will die if not immediately resuscitated.

LP450 EK76 Air Cooled Marine Nitrox Generator

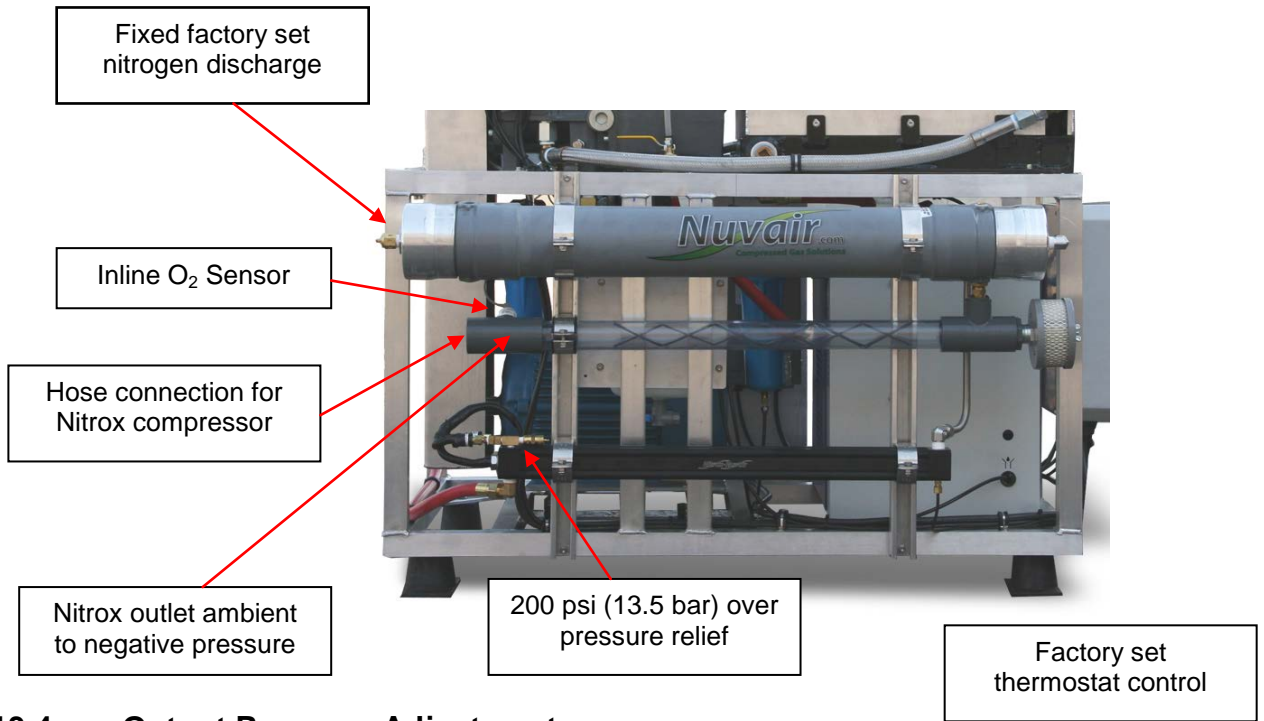

13.4 Output Pressure Adjustments

The LP compressor output is adjusted with the feed air (B.P.) regulator located on top. The feed air (B.P.) regulator can be used to adjust the output pressure from 100-175 psi (7-12 bar). This output adjustment allows the system to be used with an HP compressor having a rated capacity up to (see page 12). If your HP compressor is smaller, the inlet pressures required for the membrane system may be lower.

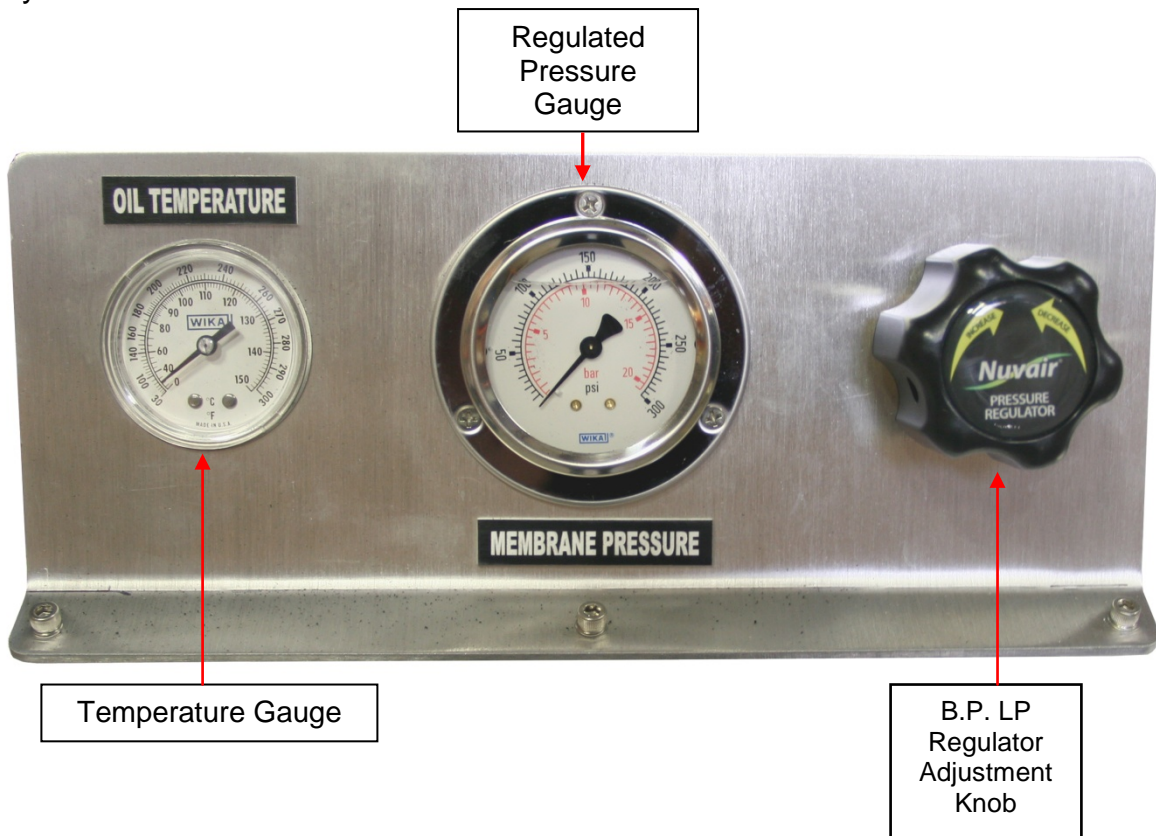

13.5 Electrical Power Connection

Electrical wiring and connections should be made by a qualified electrician in accordance with all national and local electrical codes. Check all system specifications provided in this manual. Do not use extension cords.

Proper rotation of motor fan

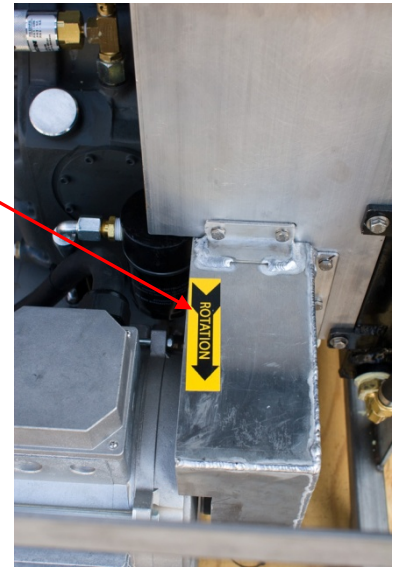

Amperage Load for System

- Approximately 47 A for 208-230 V three phase service
- Approximately 22 A for 380-415 V three phase service
- Approximately 21 A for 440-480 V three phase service

LP Compressor Rotation Check

Always turn on (bump) starter and run motor very briefly to check for proper direction of rotation. Watch that the Rotation light on the Control box is not lit.

! Notice

Operation in reverse direction for extended periods of time will cause a reciprocating compressor to run hot and perform poorly and may cause permanent damage. Reverse rotation for a rotary screw compressor for even a short period of time will cause damage.



! Warning

Never use extension cords to provide power to your nitrox system. The system must be properly wired according to national and local electrical codes by a qualified electrician. Improper wiring may lead to fires, which can cause serious personal injury or death.

Store the compressor with the power switch in the off position. **When working on the compressor the main breaker at the power source must be "locked out" and "tagged out" in the "Off" position.**

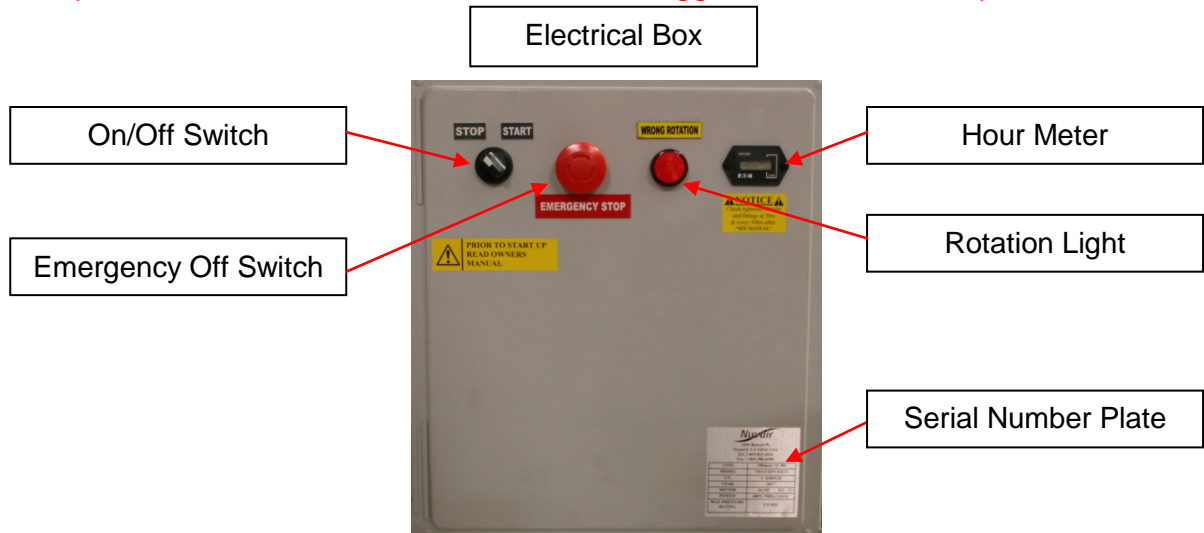

13.6 Refrigerated Air Drier

1. It is best to leave the drier on at all times. If your application requires turning the drier off when not in use. Turn the drier on at least 15 minutes before use.
2. Check that during operation the temperature gauge is operating.

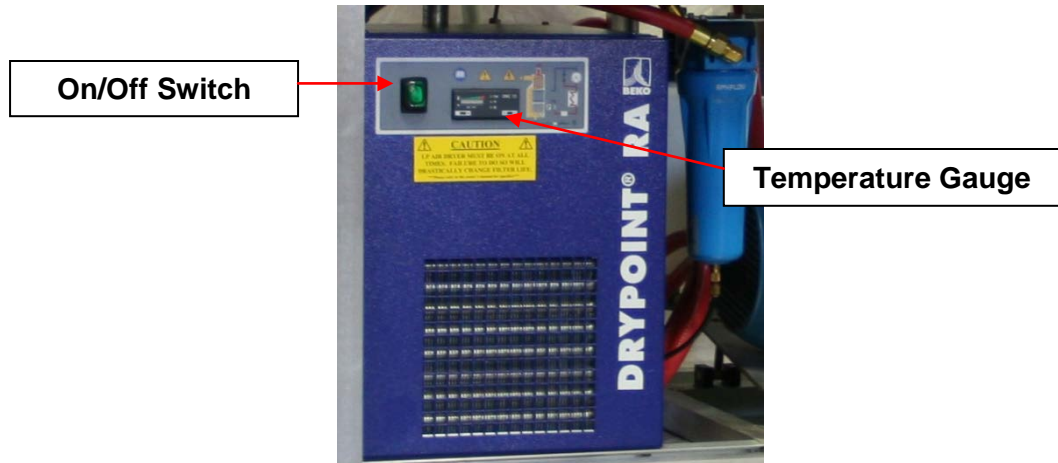

13.7 Air/Nitrox Quality Testing

Before using your nitrox system to pump nitrox, test a sample of the nitrox produced using the air/nitrox quality analysis kit provided to verify compliance with CGA standards. Quarterly testing is mandatory once the system is operational.

Air/nitrox Quality Analysis Kit



14.0 Pre-Operation Instructions



Warning

Do not allow nitrox to be discharged into the air storage system. Nitrox introduced into the air storage system could cause a diver to suffer from oxygen poisoning at depth. Oxygen poisoning is extremely dangerous and can lead to death by drowning.

Warning

Do not allow air to be discharged into the nitrox storage system. Air introduced into the nitrox storage system could cause a diver to suffer decompression sickness if the nitrox mixture is not analyzed properly and is used underwater under the assumption it is a different mix.

14.1 Compressor Lubricant Levels

Check lubricant levels before starting the LP and HP compressors, and add lubricant as required. Use only the lubricants specified. (See Section 17.3 for Lubricant Change and Hours)

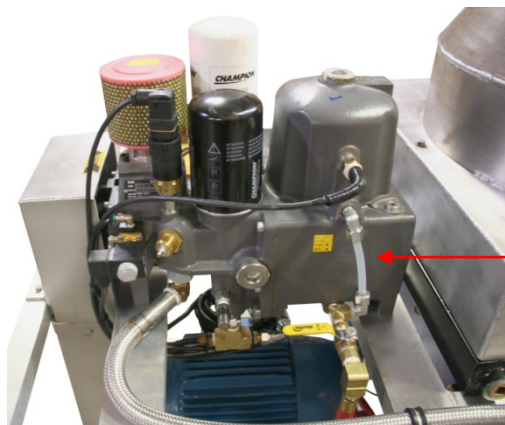

Check LP
Compressor Oil Level

14.2 Membrane System O₂% Control Knob and Flow Valve

A low pressure feed air (B.P.) regulator is used to reduce supply pressure to the membrane system to a typical range of 100–175 psi (7-12 bar). Prepare the membrane system as follows:

- 1) Reduce input pressure to minimum pressure setting by turning the (B.P.) regulator adjustment regulator knob counter-clockwise (CCW) until it spins freely.
- 2) Turn (B.P.) regulator knob clockwise (CW) until you first feel resistance, which means that the spring is starting to compress.



LP Feed Air
Pressure

LP Feed Air
(B.P.)
Regulator

14.3 Oxygen Analyzer Calibration

Gas production must be monitored with the permeate inline oxygen analyzer before the compressed gas enters the HP compressor to obtain a rough estimate of O₂% (+/- 2%). Do not rely on this reading as a proper indication of O₂% at the HP compressor outlet. Prior to pumping nitrox from the compressor, it must be monitored with the fill oxygen analyzer to obtain a precise measurement of O₂% (+/- 1%). **Both oxygen analyzers must be calibrated prior to each use.**

In-line Oxygen Analyzer Provides Rough Reading



Calibration Knob

Warning

Oxygen analyzers must be calibrated before each use. See oxygen analyzer manuals for correct calibration procedures. Improper calibration of the fill oxygen analyzer may result in the use of incorrect nitrox mixtures, which may cause serious injury or death to the diver using the gas mixture.

Warning

At altitudes above sea level, a correction factor must be used when calibrating the fill oxygen analyzer. It may not be possible to achieve all desired mixtures at altitude. See fill oxygen analyzer manual for correcting analyzer readings at various altitudes. Improper calibration of the fill oxygen analyzer may result in the use of incorrect nitrox mixtures, which may cause serious injury or death to the diver using the gas mixture.

Warning

The permeate (in-line) oxygen analyzer supplies oxygen readings that can vary +/- 2% O₂ due to heat, humidity, and pressure changes experienced in the nitrox flow and therefore should only be used for rough estimates of oxygen percentage. The fill oxygen analyzer supplies more accurate oxygen readings, within +/- 1% O₂. For cylinder nitrox fills, the user must always verify with a third independent Oxygen Analyzer.

Calibrate Oxygen Analyzers as follows:

- 1) Turn on the high pressure compressor and allow pressure to build to approx 2000 psi.
- 2) Open a pressure relief at the outlet so that the running HP compressor maintains 1500-2000 psi (100-136 bar) outlet pressure.
- 3) Power on and calibrate the oxygen analyzers while the HP compressor is pumping air. Refer to the inline oxygen analyzer manual included with the Nitrox system for details. Note that special calibration procedures may be required when operating at altitudes above sea level.

Fill oxygen analyzer –Refer to manual provided with fill analyzer

- 4) Turn on the Nitrox Generator and increase pressure at the BP regulator until the feed air pressure exceeds 100 psi, activating the Nitrox membrane heater.
- 5) Allow both compressors to run for approx 10 minutes while the membranes warm up and stabilize. Check the heater temperature gauge to verify air temperature rises and is between 105-120 °F (40-49 °C).

Now that the system temperature has stabilized, you must recalibrate the fill O₂ analyzer following the instructions laid out in the fill analyzer manual.

Notice

The oxygen analyzers may require recalibration after 10-20 minutes of operation due to humidity and temperature change effects on the sensor. To recalibrate, turn off the LP feed air and follow calibration instructions.

14.4 Filling SCUBA Cylinders

Notice

High-pressure cylinders that are filled quickly will become hot and due to the increased internal temperature the cylinder pressure will increase. This will leave a diver with less pressure inside the cylinder once cooling has occurred. This will decrease the amount of time the diver may spend underwater which may be critical during a deep dive. Customers must be warned of this possibility if cylinders are delivered for use while warm. Always fill all breathing gas cylinders slowly to avoid overheating.

15.0 Producing Nitrox

Before using your nitrox generator to pump nitrox, test a sample of the nitrox produced using the air/nitrox quality analysis kit provided to verify compliance with CGA standards or applicable standards for intended use. Quarterly testing is mandatory once the system is operational.

Warning

The equipment you will be using to manufacture nitrox (oxygen rich air) will expose you to both low and high-pressure gas. Gas, even under moderate pressures, can cause extreme bodily harm. Never allow any gas stream to be directed at any part of your body.

Notice

Do not change the temperature setting on the thermostat control without contacting Nuvair. Changes in temperature settings may cause membrane damage. A damaged membrane will not produce the correct nitrox mixture which can lead to severe personal injury if the gas is used for diving purposes without proper analysis.

15.1 Flow to Membrane

- 1) Check that BP Regulator is backed out.
- 2) Turn on your HP compressor. Allow outlet pressure to build up to approximately 2300 psi, then partially open the HP outlet or fill whip in such a manner as to maintain 1500-2300 psi
- 3) Turn on and verify that Inline AND Fill oxygen analyzers read 20.9%
- 4) Turn on LP Compressor using On/Off Switch and allow system to build up pressure until it unloads.
- 5) Turn on Membrane System by slowly turning the BP Regulator clockwise to increase pressure.
- 6) Adjust input pressure to approximately 100 psi to activate Heater Pressure Switch. Increase pressure by slowly turning the B.P. regulator knob clockwise or decrease pressure by turning the B.P. knob counter clockwise.

Verify that heater thermostat control green indicator light is on. The light will remain on until operating temperature is reached and will then cycle on and off. When light turns off, check Heater Temperature Gauge to verify air temperature is between 105-120°F (40 -49°C). Temperature is preset at the factory and changes to the thermostat control should not be required.

⚠ Caution

The on/off flow valve on the nitrox membrane system must be opened slowly. A sudden rush of gas can damage the Membrane and other system components.

⚠ Notice

The heater thermostat control green indicator light will stay on until operating temperature is reached.

⚠ Notice

Do not change the temperature setting on the thermostat control without contacting Nuvair. Changes in temperature settings may cause membrane damage. A damaged membrane will not produce the correct nitrox mixture which can lead to severe personal injury if the gas is used for diving purposes without proper analysis.

15.2 Setting Proper Pressure

The membrane system feed air pressure determines the oxygen percentage of the nitrox mixture. As pressure is increased, a higher oxygen percentage of nitrox is pumped. As pressure is decreased, a lower percentage of oxygen is pumped.

- 1) Increase input pressure by slowly turning the back pressure regulator knob clockwise while monitoring the LP pressure gauge and inline oxygen analyzer. As the pressure rises, watch the corresponding increase in the analyzer O₂% reading.
- 2) Increase or decrease pressure slowly until the inline oxygen analyzer displays the O₂% desired in the final nitrox mixture.
- 3) Allow system pressure and temperature to stabilize (approximately 5-8 minutes).
 - ◆ Regulated membrane system pressure range should be 100 – 175 psi (7-12 bar), depending on nitrox O₂% being produced.
 - ◆ Heater temperature range should be 105-120 °F (40-49 °C).



Inline Oxygen Analyzer

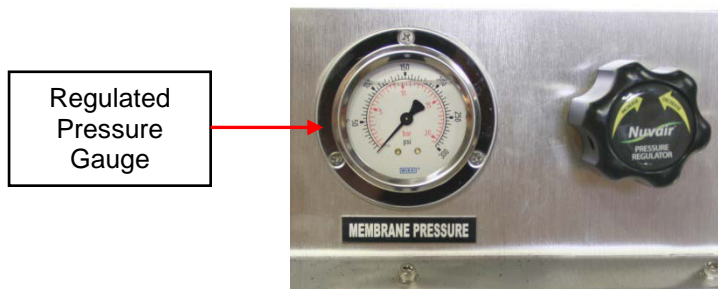

15.3 Final Adjustments Before Pumping Nitrox

- 1) As the nitrox initially makes its way through the running HP compressor, the O₂% reading on the fill oxygen analyzer will slowly increase to read approximately the same O₂% as the inline oxygen analyzer. This should happen within 3-5 minutes.
- 2) When the two analyzers read within +/- 1%, make any final adjustments to the membrane system input (feed) air pressure necessary to obtain the exact nitrox O₂% desired as indicated on the fill oxygen analyzer.
- 3) The system is now ready to pump nitrox.



Fill Oxygen Analyzer

15.4 Pumping Nitrox Warnings

Warning

The use of enriched air nitrox does not eliminate the risk of decompression sickness (DCS) in diving. Decompression sickness can lead to permanent disability or death.

Warning

The permeate O₂ analyzer supplies oxygen readings that can vary +/- 2% O₂ due to heat, humidity, and pressure changes in the nitrox flow and should only be used for rough estimates of O₂%. The fill O₂ analyzer supplies more accurate readings, within +/- 1% O₂. For SCUBA cylinder fills, the user must always verify the fill with a third independent O₂ analyzer.



Warning

Do not use this system to produce nitrox mixtures containing more than 40% oxygen. Pumping nitrox mixtures with higher concentrations of oxygen may lead to fires or explosions, which can cause serious personal injury or death.



Warning

Do not pump nitrox mixtures at pressures above the HP compressor rating, and never above 3600 psi (250 bar). The system is not rated for pressures above 3600 psi (250 bar). Higher pressures may lead to explosions which may cause serious personal injury or death.

Notice

No oxygen cleaning of standard cylinders or plumbing is mandatory when using the nitrox system to produce nitrox containing a maximum of 40% oxygen. When filling oxygen clean cylinders, hyper-purification of the nitrox is required using an optional oxygen compatible air purification system available from Nuvair.



Warning

This nitrox system does not produce nitrox mixtures acceptable for 100% oxygen service. Mixing nitrox mixtures with 100% pure oxygen may lead to fires and / or explosions, which may cause serious personal injury or death.



Warning

Never fill a cylinder that is marked, "For Oxygen Service," with nitrox that has been produced by anything other than 100% oxygen clean system. Filling an oxygen clean cylinder with breathing gas containing hydrocarbons can lead to explosions if the cylinder is subsequently filled with gas mixtures containing gas mixtures containing greater than 40% oxygen. Explosions may cause serious injury or death.

Warning

Only provide SCUBA cylinder nitrox fills to customers who have proof of nitrox training and certification. Improper use of nitrox can cause severe personal injury or death.



Danger

This system is not cleaned for oxygen service and not all components are compatible with gas mixtures containing greater than 40% oxygen. Pumping gas mixtures containing greater than 40% oxygen will lead to explosions which may cause severe personal injury or death.

Warning

Each SCUBA cylinder belonging to a customer must be analyzed by that customer at the nitrox filling facility, using an oxygen analyzer independent of those used with the nitrox system. An employee must witness that the customer has properly analyzed the gas in each cylinder, noted the maximum operating depth for that mixture, and signed and dated the fill log. The time of day must also be included with the date, since some customers may fill the same cylinder more than once a day.

Warning

Each SCUBA cylinder belonging to a customer must be analyzed by that customer at the nitrox filling facility, using an oxygen analyzer independent of those used with the nitrox system. An employee must witness that the customer has properly analyzed the gas in each cylinder, noted the maximum operating depth for that mixture, and signed and dated the fill log. The time of day must also be included with the date, since some customers may fill the same cylinder more than once a day.

Fill SCUBA cylinders or HP storage tanks as follows:

- 1) When filling a SCUBA cylinder, follow all industry standards. Do not exceed rated pressure of cylinder, and do not exceed 3600 psi (250 bar) under any condition.
- 2) With fill whip bleed valve open and nitrox flowing, verify that fill oxygen analyzer O₂% reading equals the desired nitrox O₂%.
- 3) Close bleed valve, open cylinder valve, and fill cylinder. While filling, monitor system for proper operation:
 - a) Monitor Oxygen Analyzers and recalibrate as required
 - b) Manually drain all Compressor condensate every 10-15 minutes and listen for proper operation of auto-drains if equipped.
 - c) Monitor all system gauges for recommended settings below.

! Notice

The Oxygen Analyzers may require re-calibration after 10-20 minutes of operation due to humidity and temperature change effects on the sensor. To recalibrate, turn off the LP feed air switch and follow calibration instructions.

! Notice

When the HP compressor auto drain engages and dumps condensate, the fill oxygen analyzer reading will decrease momentarily due to the pressure drop in the system. It will return to its previous reading within seconds after the auto drain sequence stops.

GAUGE	RECOMMENDED SETTING
Compressor gauges	According to manufacturers recommendations
Heater Temperature	104-120° F (40-49° C)
Cabinet Temperature	Less than 104 Degrees F (40 °C)
Membrane Feed Air Pressure	90 - 175psi (6-12bar) Depending on the Nitrox O ₂ %
Fill Oxygen Analyzer	Showing the proper reading for intended fill
Nitrox Storage Pressure	DO NOT exceed rating of tank or 3600 P.S.I. (250Bar)

- 4) After filling is complete, close cylinder valve, vent the bleed valve, and remove the cylinder.
- 5) Test the nitrox O₂% in the cylinder using an independent oxygen analyzer such as the Nuvair O₂ Quickstick™. Calibrate analyzer before use in accordance with manufacturer's instructions.
- 6) Repeat steps 1-5 until you have filled all SCUBA cylinders.
- 7) Mark each tank with fill date, O₂%, fill pressure, and MOD (Maximum Operating Depth) in user's handwriting.



Use Independent Oxygen Analyzer for Verification

- 8) Log every nitrox fill to document the following information:
 - Fill date and time of day
 - Tank serial number
 - Supplier's check of oxygen content O₂% plus signature and date
 - User's check of oxygen content O₂% plus signature and date
 - Fill pressure
 - MOD (Maximum Operating Depth) in user's handwriting
 - Nitrox certifying agency and card number
- 9) When filling a HP nitrox storage tank, verify that fill oxygen analyzer O₂% reading equals the desired nitrox O₂%. Open applicable line valves and tank valve, and fill with nitrox. Do not exceed rated pressure of cylinder, and do not exceed 3600 psi (250 bar) under any condition. After filling is complete, close all valves and allow the nitrox system to shut down.

Notice

High-pressure cylinders that are filled quickly will become hot and due to the increased internal temperature the cylinder pressure will increase. This will leave a diver with less pressure inside the cylinder once cooling has occurred. This will decrease the amount of time the diver may spend underwater which may be critical during a deep dive. Customers must be warned of this possibility if cylinders are delivered for use while warm. Always fill all breathing gas cylinders slowly to avoid overheating.

15.5 Shutting Down

- 1) Shut off the nitrox membrane system by turning the regulator adjustment knob CCW to reduce input pressure to minimum setting and then closing the On/Off flow valve.
- 2) Manually drain all filter, compressor, and optional volume tank condensate drains.
- 3) Turn off LP compressor On/Off Switch. The compressor will go into shut down mode.
- 4) Turn off HP compressor when it has returned to pumping air, as determined by a fill oxygen analyzer reading close to 20.9% O₂.
- 5) Shut down the refrigerated air dryer if so equipped.

16.0 Nitrox Operation Notes

- Ensure all personnel who operate the system are properly trained in its use.
- Keep a log with details of each cylinder filled with nitrox, including the time and date, name of operator of system, name and certification number of diver, gas analysis, MOD, and cylinder pressure.

16.1 Correlation of Input Pressure to Oxygen Content

After the 10 hour break-in period for your nitrox system, you will notice that specific nitrox oxygen percentages always match specific input (feed) pressures once the system has warmed up. These pressures and percentages will be repeatable. If you find that the fill oxygen analyzer reads 36% O₂ when the input (feed) air pressure is at 125 psi (9 bar) record this pressure or make a mark on the input (feed) air pressure gauge indicating the O₂%. Do this for each O₂% that you normally make, making sure system has warmed up first. The next time nitrox with 36% O₂ is needed, adjust the regulator to 125 psi (9 bar) and wait for the oxygen analyzer reading to stabilize. You will find the analyzer reading to be very close to 36% O₂, requiring only minor adjustments of the regulator to achieve the exact desired O₂%.

Notice

Use the fill oxygen analyzer to verify the nitrox oxygen percentage prior to pumping. When using the feed air pressure reading to obtain specific oxygen percentage, minor adjustments of the feed air pressure regulator may be required to obtain the exact percentage desired.

16.2 Hot Fills

While in the process of filling HP nitrox storage tanks, you may have a need to supply a walk-in customer with a SCUBA cylinder fill of a different nitrox mix. You can change mixes as follows:

- 1) With the nitrox system and HP compressor operating, isolate the HP nitrox storage tanks from the HP compressor by closing appropriate valves.
- 2) Record the membrane system input pressure reading
- 3) Slightly open fill whip valve on the HP compressor, and adjust so the running compressor maintains 1500-2000 psi (100-136 bar) outlet pressure.
- 4) Adjust the input (feed) air regulator to the pressure corresponding to the desired nitrox O₂% for the SCUBA cylinder fill.
- 5) Allow the fill oxygen analyzer reading to stabilize, make any minor adjustments necessary to achieve the desired O₂%, and then fill cylinder in normal manner.
- 6) When finished return regulator to previous setting, and allow the fill oxygen analyzer reading to stabilize. Make any minor adjustments necessary to achieve the desired O₂%, and then resume filling storage tanks.

17.0 Maintenance

The following list of daily and routine maintenance items is intended as a guide. Refer to LP and HP compressor manuals for complete maintenance requirements.

17.1 Daily Maintenance

Caution

Be sure to check compressor lubricant levels prior to each day of operation. Failure to ensure the proper lubricant level will lead to system damage.

- 1) Check lubricant levels of both LP and HP compressors and add proper lubricants as required. See Section 14.1 and compressor manuals for details.
- 2) Check HP compressor filtration for condensate and proper operation of condensate drains. Refer to HP compressor manual for details.
- 3) Check LP filtration for condensate and proper operation of condensate drains.



Warning

Use only the specified Nuvair lubricants in this system. The use of incompatible lubricants presents a risk of fire and/or explosion, and may result in system damage. This can lead to severe personal injury and death.



Warning

Be sure that all pressure has been relieved from the system prior to opening any filtration canister. Failure to vent pressure from the system prior to opening the canister can lead to serious personal injury or death.

Caution

If system is located in an area where there is high humidity and high heat, the life of all filtration elements may be as little as 35% of rated operating capacity. Check the compressor manual and appendix for details on filter element life factors.

17.2 Routine Maintenance

- 1) LP compressor Lubricant: Change rotary screw compressor lubricant and lubricant filter after the first 50 hour break in period. Change oil every 500 hours thereafter. Only use lubricants rated for use with rotary screw compressors, such as Nuvair 546™. Never mix compressor lubricants. See section 17.3 and LP compressor manual for details.
- 2) LP filtration Inspection: On a weekly basis, inspect each filter bowl for the presence of moisture and each element for any unusual degradation or wetness. No moisture should be in the final filter housing. (do not use system with moisture in the final filter housing) See Section 17.4 for details.

⚠ Caution

Special attention needs to be given to the arrangement of the four LP air filtration elements and bowls. Properly reinstall each element and bowl to the correct Housing. Improper sequence can cause damage to downstream components.

3) LP Filtration Elements: Change LP filters elements every 250 hours or yearly to maintain CGA Grade D air standards. Visually check differential pressure (DP) indicators on the HF7 and HF5 filters assist with monitoring replacement intervals. See Section 17.4 for details. If the nitrox system is operated in high humidity and/or high temperature, filter elements must be changed more often. See Appendix for details on Filter element life factors.

4) Semi-Permeable Membrane: No maintenance required. Service life exceeds 20 years if LP filtration is properly serviced to maintain Grade D air standards.

5) Membrane System Air Intake Filter: Inspect filter element every 3 months for visible particles. Change every 12 months or sooner if particles are visible.

6) Oxygen Analyzers: Replace oxygen sensor and battery as required. See manual included with nitrox system.

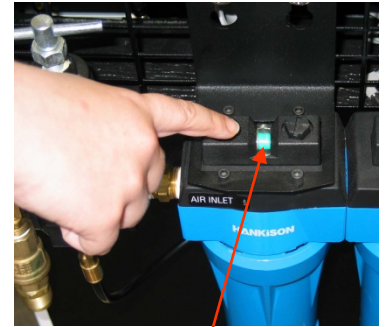

DP Indicator Changes from Green to Red as Filter Ages. Do Not Use When Red.

Air Intake Filter



⚠ Danger

Do not swallow (ingest) either the electrolyte from the oxygen sensor or the sensor itself. The Potassium Hydroxide chemical contained in the sensor can cause severe injury or death. If electrolyte or the Sensor is swallowed, seek medical attention immediately.



⚠ Danger

If after handling the oxygen analyzer or sensor, you find that your fingers or other parts of your body feel “slippery” or the skin or eyes sting, immediately flush affected area with clean, fresh water for at least 15 minutes. The stinging or slippery sensation is an indication of a leaking Sensor. The Potassium Hydroxide chemical contained in the sensor can cause severe injury or death. Seek immediate medical attention if eye contact is made or skin stinging persists.

The following items are not integral parts of the nitrox system, but proper maintenance is required to assure optimum performance.

- 1) HP Compressor Lubricant: Change HP compressor lubricant every 100 hours of operation in accordance with manufacturer’s guidelines. Only use lubricants rated for use with nitrox, such as Nuvair 455 or 751. ever mix compressor lubricants. Refer to HP compressor manual for details.
- 2) Breathing Air Filters: Change HP compressor filter elements in accordance with manufacturer’s guidelines to maintain CGA Grade E breathing air standards.
- 3) Air/Nitrox Quality Analysis: Take breathing air/nitrox samples quarterly for analysis to assure compliance with CGA Grade E breathing air standards.

17.3 Compressor Lubricant

The LP rotary screw compressor in your nitrox system uses Nuvair 546 food grade synthetic rotary screw compressor lubricant for rotary screw compressors. Customers may specify different lubricants, only use acceptable lubricants. This lubricant is thinner than the lubricants that are used in reciprocating HP compressors and must not be mixed with other compressor lubricants.

For access to the lubricant level sight gauge, filter, and drain, the front panel of the cabinet must be opened. Turn off all electrical power to nitrox system before opening cabinet.

See LP compressor manual for details on servicing lubricant and filter.

Change LP Oil:

- After the first 50 hours of use
- Every 500 hours or annually

Change LP compressor air and oil filters:

- Every 500 hours or annually

Change air/oil separator element:

- Every 2000 hours or annually



Warning

Use only the specified Nuvair lubricants in this system. The use of incompatible lubricants presents a risk of fire and/or explosion, and may result in system damage. This can lead to severe personal injury or death.

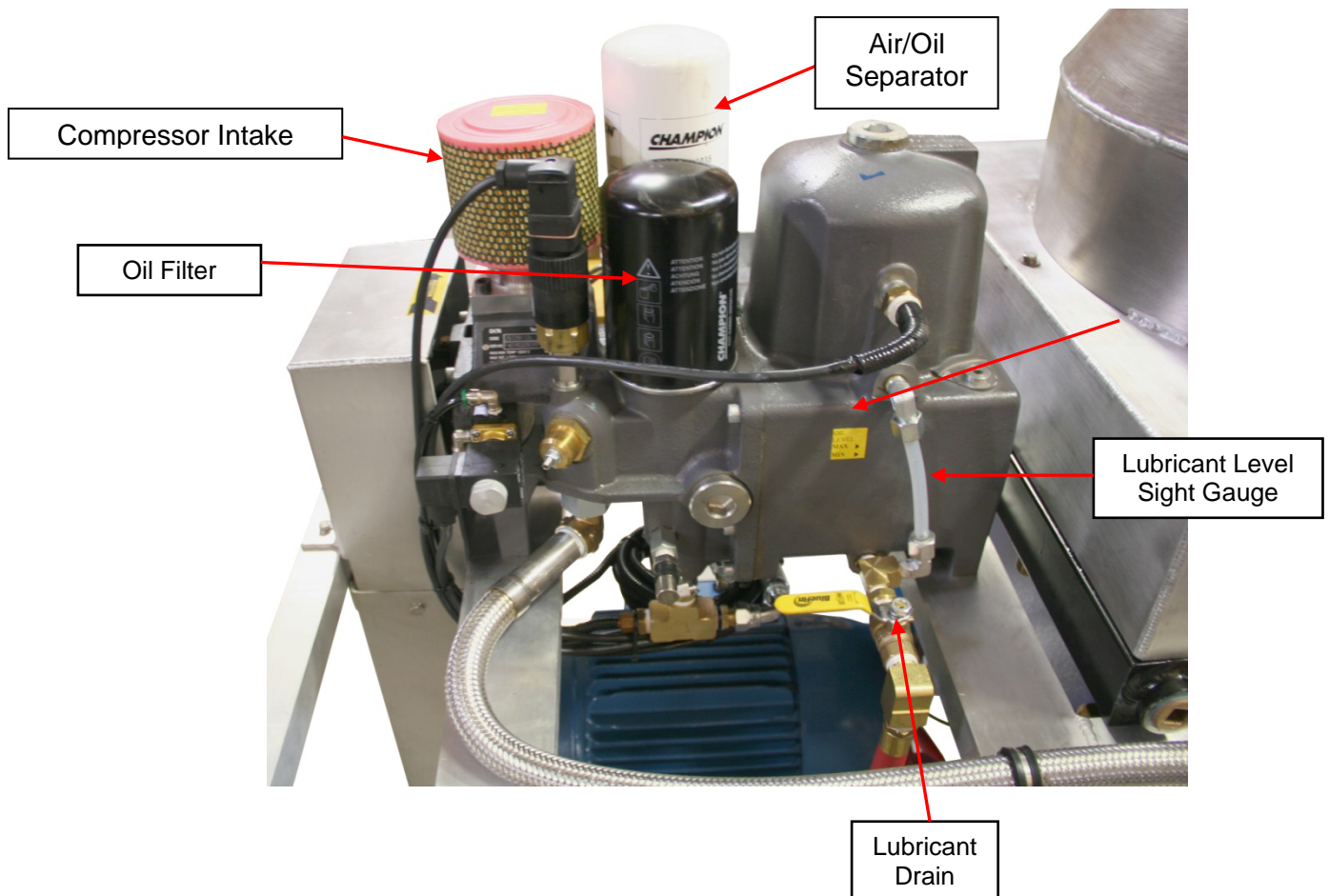

Warning

Never mix different lubricants together because equipment damage may occur when machinery is operated with improper lubricant.



Warning

Do not carry out any maintenance tasks if the compressor has just shut down. Wait for the compressor to cool to avoid skin burns.

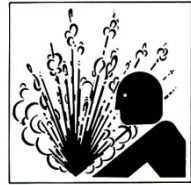

Warning

Pressure must be properly drained from the system before opening the LP fill plug. Failure to drain pressure may result in severe personal injury.



Warning

Any oil spilled during the oil and oil filter change could cause personnel to slip and fall. Wear anti-slip footwear. Remove any traces of spilled oil immediately. Slips and falls may cause severe personal injury or death.

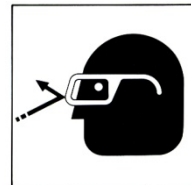

Caution

Wear eye protection, gloves, and skin protection when performing oil changes. Although the oil is not classified as a dangerous substance, the oil can be irritating to your eyes and skin.

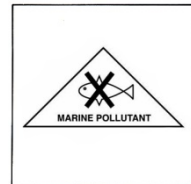

Caution

Both oil and oil filter are classified as “special wastes” and must be disposed of properly according to applicable national and local laws. Failure to dispose of these wastes properly can lead to death of wildlife as well as government fines and penalties.



Warning

All maintenance work must be carried out with the compressor off and the power supply lead unplugged from the main socket. Appropriate steps must be taken to tag out and lock out the electrical power. Failure to isolate this equipment from the power source while performing maintenance may result in severe personal injury or death.

17.4 LP Filtration

! Caution

Special attention needs to be given to the arrangement of the four LP feed air filtration elements and bowls. Properly reinstall each element and bowl to the correct housing. Improper sequence can cause damage to downstream components.

The use of Grade D or better supply air is critical to prevent the passing of any residual oil vapor into the membrane system. Three stages of Hankison LP filtration are used to produce Grade D air:

- 1) Particle Removal to 1 micron (Model No. HF7-20)
- 2) Coalescing & Water/Oil Vapor Removal to 0.01 micron (Model No. HF5-20)
- 3) Oil Vapor Removal to 0.003 PPM (Model No. HF1-20)

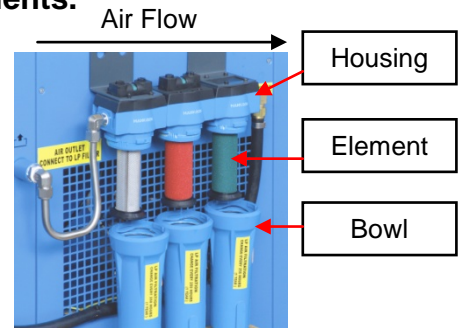

HF7-20 Particle Removal	HF5-20 Coalescing & Water/ Oil Vapor Removal	HF1-20 Oil Vapor Removal
-------------------------------	--	--------------------------------

Filtration Inspection

Open each Filter and inspect as follows:

1. Inspect bowl for the presence of moisture. A high level of moisture build-up in the HF7 or HF5 filter indicates improper operation of auto-drain floats. Any evidence of moisture in the HF1 Filter indicates the air is not cooling properly and moisture is not properly being removed. Excess moisture will prevent the final filter from operating properly.
2. Inspect Elements for any unusual degradation or wetness. Element degradation can indicate more serious problems. Contact Nuair for assistance.

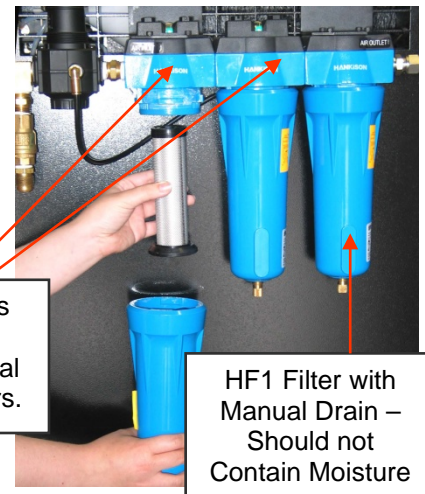

Changing Filtration Elements

Change Filter Elements every 250 hours if operated with the refrigerated air drier. If the nitrox generator is operated in high humidity and/or high temperature or without the drier, filter elements must be changed more often. See Appendix for details on Filter Element Life Factors. Visual differential pressure indicators on the HF7 and HF5 filters assist with monitoring replacement intervals.

- 1) Push up on the Bowl, rotate CCW, and lower to remove.
- 2) Gently rotate filter element and pull down off mounting post.
- 3) Replace element and reassemble in reverse order.

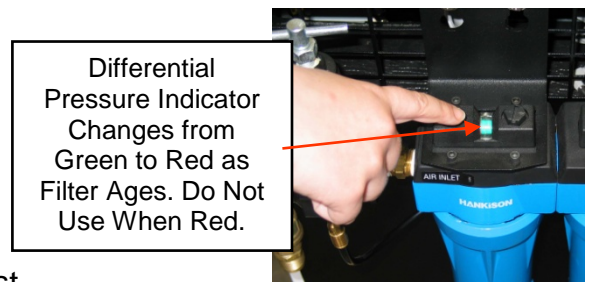

! Notice

The interior of the filter bowls can be cleaned with a diluted solution of Simple Green™ and flushed thoroughly with clean water. This will assist to prolong the life of the element, bowl, and auto drain.

LP450 EK76 Air Cooled Marine Nitrox Generator

17.5 Spare Parts List

See Rotary Screw Compressor manual for LP compressor parts list. Other nitrox generator components and related items are listed below.

Nitrox System Components	Type	Part Number
Low Pressure Filtration		
LP Filtration Element	Hankison HF 7-20	E7-20
	Hankison HF 5-20	E5-20
	Hankison HF 1-20	E1-20
Rotary Screw Compressor Lubricant		
Rotary Screw Compressor Lubricant, Food Grade	Nuvair 546, 1 Gal (Other Sizes Available)	9409
Rotary Screw Compressor Maintenance Items		
Rotary Screw Air Intake Filter	EK76	A11207674
Rotary Screw Air Oil Separator	EK76	300KBA035
Rotary Screw Oil Filter	EK76	300KBA1446
Nitrox Generator Components		
Air Intake Filter Element	Mixing Tube	18P
Analyzer Replacement Sensors		
Pro O ₂	Replacement Sensor	9505
Pro O ₂ Remote Panel Mount	Replacement Sensor	9506
Related Equipment Components		
Air/Nitrox Quality Analysis Kit	Specify: (1) CGA Grade Required (2) Single Use or Program Use	
Air/Nitrox (Reciprocating) Compressor Lubricant		
Reciprocating Compressor, Food Grade	Nuvair 455, 1 Gal	9406
Reciprocating Compressor, Diester Based	Nuvair 751, 1 Gal	9403

17.6 Service Record Log

Date	Technician Name	Service Performed

Appendix

Supply and Breathing Air Specifications

All supply and breathing air must meet the following requirements of CGA G-7.1-1997. Supply air delivered to the nitrox membrane system must be purified to meet Grade D or E quality, DIN 3188, EN 12021, CGA E and CSA and periodic air quality testing to assure compliance is recommended. All breathing air for diving produced by the downstream compressor must be purified to meet Grade E, DIN 3188, EN 12021, CGA E and CSA quality, and periodic air quality testing to assure compliance is mandatory.

Item	Grade D	Grade E
Oxygen	19.5-23.5%	20-22%
Carbon Dioxide (maximum)	1000 PPM	1000 PPM
Carbon Monoxide (maximum)	10 PPM	10 PPM
Hydrocarbons (maximum)	Not specified	25 PPM
Water Vapor (maximum)	Not specified	Not specified
Dew Point (maximum) (1)	Not specified	Not specified
Oil & Particles (maximum) (2)	5 mg/m ³	5 mg/m ³
Odor	None	None

Notes: (1) Dew Point of supply air must be >10°F (6°C) colder than coldest ambient air expected
 (2) Supply air delivered to the membrane system must contain <0.003 PPM oil vapor

All breathing nitrox produced for diving must be purified to meet these same requirements, except for oxygen content. Nitrox oxygen content must measure within +/- 1% O₂ of the specified value of the mixture using a properly calibrated oxygen analyzer (i.e. nitrox produced with a target content of 32% O₂ must measure in the range of 31-33% O₂). Periodic air quality testing to assure compliance is mandatory.

Filter Element Life Factors

Breathing air filter element life is typically rated by manufacturer based on an air temperature of 80°F at the filter inlet. Under normal operation this temperature is 12°F (5°C) warmer than the ambient air, resulting in an equivalent ambient temperature rating at 68°F (20°C).

To determine element life at a different ambient temperature, multiply the rated life by the life factor listed below:

Filter Temperature	Ambient Temperature	Filter Element Life Factor
53°F (12°C)	41°F (5°C)	2.6 x Life
62°F (17°C)	50°F (10°C)	1.8 x Life
71°F (23°C)	59°F (16°C)	1.35 x Life
80°F (27°C)	68°F (20°C)	1 x Life
89°F (32°C)	77°F (25°C)	0.8 x Life
96°F (36°C)	84°F (29°C)	0.55 x Life
105°F (41°C)	93°F (34°C)	0.45 x Life
114°F (46°C)	102°F (39°C)	0.35 x Life

OWNER'S WARRANTY RESPONSIBILITIES

Failure of the owner to prevent equipment damage by complying with the procedures outlined below and in the operation manual will void the nitrox system warranty.

Installation:

- All set up requirements and procedures provided in the nitrox system operation manual must be followed in their entirety including supply air cleanliness, compressor preparation, and installation of the nitrox system.
- Supply air to the membrane must be properly filtered to oil free CGA Grade D air quality or better to prevent damage to the membrane. Air quality testing of the supply air should be performed periodically and documented to assure compliance.
- If there is any doubt regarding the suitability of a HP or LP compressor for compressing nitrox, contact Nuvair or the compressor manufacturer before you connect your nitrox system.
- If an existing HP or LP compressor is to be used for compressing nitrox, all traces of the old lubricant must be removed and replaced with a nitrox compressor lubricant approved by Nuvair.
- Electrical wiring and connections should be made by a qualified electrician in accordance with all national and local electrical codes.
- Do not change the temperature setting on the heater thermostat control. Changes in temperature settings may cause membrane damage.
- To prevent compressor damage, only use the compressor Intake Hose provided. If a longer hose is required, contact Nuvair for assistance.
- Compressors must be provided adequate ventilation to operate properly and prevent heat damage. This requires an ambient temperature below 104 ° F (40 ° C), sufficient clearance from adjacent walls, and proper rotation direction.

Operation:

- Do not use the nitrox system to supply a HP or LP compressor with nitrox mixtures containing more than 40% oxygen. Compressing higher concentrations of oxygen may cause severe compressor damage.
- Do not pump nitrox mixtures at pressures above the compressor manufacturer's rating, and never above 3600 psi (250 bar). Compressing nitrox at higher pressures may cause severe HP compressor damage.
- To prevent membrane damage, drain all low pressure filters and condensate tanks on a daily basis.
- If you become aware of an operational fault, stop using the equipment immediately and contact Nuvair for assistance.

Maintenance:

- Change low pressure filter elements on a schedule determined by filter capacity and ambient temperature and humidity. Contact Nuvair if you need assistance establishing a schedule for your equipment and location.
- Replace membrane system air intake filter on a regular basis to prevent flow obstruction.
- Keep all nuts, bolts, fittings, connectors, and clamps tight.
- Keep a service record book showing that regular maintenance work has been carried out. If a warranty claim becomes necessary, it will aid in demonstrating that damage has not been caused by insufficient maintenance. Proof of maintenance may be required prior to determining the validity of a warranty request.

NUVAIR NITROX SYSTEM WARRANTY

Nuvair extends a limited warranty, which warrants the nitrox system to be free from defects in materials and workmanship under normal use and service for a limited period. The specific membrane component of the nitrox system is warranted according to the pro-rated terms as set forth below. All other Original Equipment Manufacturer (OEM) components used in the system are warranted only to the extent of the OEM's warranty to Nuvair. Nuvair makes no warranty with respect to these OEM components, and only warrants the workmanship that Nuvair has employed in the installation or use of any OEM component. This warranty is not transferable.

Nuvair will, at its discretion and according to the terms as set forth within, replace or repair any materials which fail under normal use and service and do not exhibit any signs of improper maintenance, misuse, accident, alteration, weather damage, tampering, or use for any other than the intended purpose. Determination of failure is the responsibility of Nuvair, which will work together with the customer to adequately address warranty issues. When any materials are repaired or replaced during the warranty period, they are warranted only for the remainder of the original warranty period. This warranty shall be void and Nuvair shall have no responsibility to repair or replace damaged materials resulting directly or indirectly from the use of repair or replacement parts not approved by Nuvair.

Pro-Rated Terms:

Nuvair warrants the membrane component of the nitrox system to be free from defects in material and workmanship for a period of thirty-six (36) months from date of installation or forty-two (42) months from date of shipment by Nuvair, whichever may occur first. The warranty covers parts only and is prorated as follows:

- First Year Repair or replacement free of charge
- Second Year Warranty allowance of 70% of the current membrane component list price
- Third Year Warranty allowance of 40% of the current membrane component list price

A warranty registration card, supplied with system documentation, must be filled out and submitted to Nuvair for the warranty to be in full effect. If the warranty registration card is not received within thirty (30) days of installation, the thirty-six (36) month warranty will begin with the date of shipment from Nuvair. For warranty service to be considered, customer's account must be current or paid in full.

Maintenance Items:

Any materials which are consumed, or otherwise rendered not warrantable due to processes applied to them, are considered expendable and are not covered under the terms of this policy. This includes maintenance and consumable items listed as part of a suggested maintenance program included with system documentation.

Return Policy:

Application for warranty service can be made by contacting Nuvair during regular business hours and requesting a Return Material Authorization (RMA) number. Materials that are found to be defective must be shipped, freight pre-paid, to the Nuvair office in Oxnard, California. Upon inspection and determination of failure, Nuvair shall exercise its options under the terms of this policy. Warranty serviced materials will be returned to the customer via Nuvair's preferred shipping method, at Nuvair's expense. Any expedited return shipping arrangements to be made at customer's expense must be specified in advance.

Limitation of Warranty and Liability:

Repair, replacement or refund in the manner and within the time provided shall constitute Nuvair's sole liability and the Purchaser's exclusive remedy resulting from any nonconformity or defect. Nuvair shall not in any event be liable for any damages, whether based on contract, warranty, negligence, strict liability or otherwise, including without limitation any consequential, incidental or special damages, arising with respect to the equipment or its failure to operate, even if Nuvair has been advised of the possibility thereof. Nuvair makes no other warranty or representation of any kind, except that of title, and all other warranties, express or implied, including warranties of merchantability and fitness for a particular purpose, are hereby expressly disclaimed. No salesman or other representative of Nuvair has authority to make any warranties.

Additional Record of Changes

It is the responsibility of the owner of this product to register their ownership with Nuvair by sending the warranty card provided to Nuvair. This card is to establish registration for any necessary warranty work and as a means of communication that allows Nuvair to contact the user regarding this product.

The user must notify Nuvair of any change of address by the user or sale of the product. All changes or revisions to this manual must be recorded in this document to ensure that the manual is up to date.

Nuvair will post the most all new revisions of current manuals on our website at:

www.nuvair.com/manuals

Change Date	Description of Change
08.18	New LP450 EK76 Manual

NOTES:



Nuvair
Phone: +1 805 815 4044
Fax: +1 805 486 0900
1600 Beacon Place
Oxnard, CA 93033
USA
info@nuvair.com
www.nuvair.com

Revision 08.18