



User Manual

**LP600 EK76**

**Water Cooled Marine  
Nitrox Generator**

# ***LP600 Water Cooled Marine Nitrox Generator***

If you have any questions on this equipment please contact Technical Support at:

Nuvair  
1600 Beacon Place  
Oxnard, CA 93030, USA

Phone: +1 805 815 4044

Fax: +1 805 486 0900

Email: [info@nuvair.com](mailto:info@nuvair.com)

Hours: Monday through Friday  
8:00 AM to 5:00 PM PST USA

If you lose this manual, you can download the latest version at [www.nuvair.com](http://www.nuvair.com).

## **Warning**

**This user manual contains important safety information and should always be available to those personnel operating this equipment. Read, understand, and retain all instructions before operating this equipment to prevent injury or equipment damage.**

Every effort was made to ensure the accuracy of the information contained within. Nuvair, however, retains the right to modify its contents without notice. If you have problems or questions after reading the manual, stop and call Nuvair at +1 805 815 4044 for information.

## Table of Contents

### Introduction

1.0	Introduction .....	4
2.0	Safety Warnings and Warning Graphics Defined.....	5
3.0	Safety and Operation Precautions .....	7
4.0	Legal Precautions .....	8
5.0	Theory of Operation .....	9
6.0	Low Pressure Rotary Screw Compressor Technical Data .....	10
7.0	System Components .....	11
8.0	nitrox System Specifications .....	12
9.0	LP600 Generator Component Identification.....	13
10.0	System Drawing/Schematic .....	16
11.0	System Flow Chart .....	17

### Setup, Operation, and Maintenance

12.0	Preparing Existing HP Compressors.....	18
	12.1 Purification System Air/nitrox Quality .....	18
	12.2 Replacement of Compressor Lubricant .....	18
	12.3 Installation of Fill Oxygen Analyzer .....	19
13.0	Installing the LP600 nitrox Generator.....	20
	13.1 Precautions .....	20
	13.2 Attaching Compressor Intake Hose .....	21
	13.3 Attaching Nitrogen Discharge Hose (Optional) .....	21
	13.4 Output Pressure Adjustments .....	22
	13.5 Electrical Power Connection .....	23
	13.6 Refrigerated Air Drier .....	24
	13.7 Air/nitrox Quality Testing .....	24
14.0	Pre-Operation Instructions .....	24
	14.1 Compressor Oil Levels .....	25
	14.2 Membrane System O <sub>2</sub> % Control and Flow Valve .....	25
	14.3 Oxygen Analyzer Calibration .....	27
	14.4 Attaching Scuba Cylinder .....	28
15.0	Producing nitrox .....	29
	15.1 Flow to Membrane and Setting Proper Pressure.....	29
	15.2 Setting Proper Pressure .....	30
	15.3 Final Adjustments Before Pumping nitrox .....	31
	15.4 Pumping nitrox .....	33
	15.5 Pumping Air .....	34
	15.6 Shutting Down .....	34
16.0	nitrox Operation Notes .....	34
	16.1 Correlation of Input (Feed) Air Pressure to Oxygen Content.....	35
	16.2 Hot Fills .....	35
17.0	Maintenance .....	36
	17.1 Daily Maintenance .....	36
	17.2 Routine Maintenance .....	36
	17.3 Compressor Lubricant .....	38
	17.4 LP Filtration Inspection and Changing.....	40
	17.5 Spare Parts List .....	41
	17.6 Service Record Log .....	42
Appendix .....		43
	Supply and Breathing Air Specifications .....	43
	Filter Element Life Factors .....	43
	Owner's Warranty Responsibilities .....	44
	Warranty .....	45
	Additional Records of Change .....	46

### Separate Manuals Supplied:

Nuvair Pro O<sub>2</sub><sup>TM</sup> Oxygen Analyzer Operation Manual

## 1.0 Introduction

Nuvair has taken extreme care in providing you with the information you will need to operate this system. However, it is up to you to carefully read this manual and make the appropriate decisions about system safety.

This manual will assist you in the proper set-up, operation and maintenance of the Nuvair LP600 ME nitrox system. Be sure to read the entire manual.

Throughout this manual we will use certain words and symbols to call your attention to conditions, practices, and / or techniques that may directly affect your safety. Pay particular attention to information introduced by the following signal words:

### **Danger**

Indicates an imminently hazardous situation, which if not avoided, will result in serious personal injury or death.

### **Warning**

Indicates a potentially hazardous situation, which if not avoided, could result in serious personal injury or death.

### **Caution**

Indicates a potentially hazardous situation, which if not avoided, may result in minor or moderate injury. It may also be used to alert against unsafe practices.

### **Notice**

Notifies people of installation, operation or maintenance information which is important but not hazard-related.

2.0 Safety Warnings

 **Warning**

This equipment is used to provide breathing gas for the purpose of underwater life support. Read this manual in its entirety. Failure to heed the warnings and cautions contained in this document may result in severe injury or death.

 **Warning**

The equipment you will be using to manufacture nitrox (oxygen rich air) will expose you to both low and high-pressure gas. Gas, even under moderate pressures, can cause extreme bodily harm. Never allow any gas stream to be directed at any part of your body.

 **Warning**

Any pressurized hose can cause extreme harm if it comes loose or separates from its restraint (or termination) while under pressure and strikes any part of your body. Use appropriate care in making and handling all gas connections.

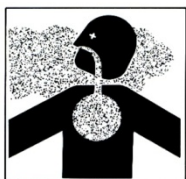

 **Danger**

Pure nitrogen is a colorless, odorless, tasteless gas that will not support life. Breathing gas mixtures containing more than 84% nitrogen at surface pressures will lead to unconsciousness and may cause death.

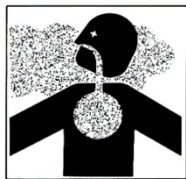

 **Warning**

The nitrogen discharge from the membrane system must be vented to the exterior of any closed building, boat, or similar enclosed space. Breathing gas mixtures containing more than 84% nitrogen at surface pressure will lead to unconsciousness and may cause death.



 **Warning**

Do not use any form of mineral oil or synthetic lubricant not rated for nitrox in any compressor in this system. Use only the recommended nitrox compressor lubricant. Never mix the nitrox compressor lubricant with other lubricants. Remove all existing lubricant and replace with the proper nitrox compressor lubricant prior to installing the membrane system. The use of improper lubricants can lead to fire or explosions, which may cause serious personal injury or death.



 **Warning**

Do not use this system to produce nitrox mixtures containing more than 40% oxygen. Pumping nitrox mixtures with higher concentrations of oxygen may lead to fires or explosions, which can cause serious personal injury or death.

## ⚠ Warning

The use of enriched air nitrox does not eliminate the risk of decompression sickness (DCS) in diving. Decompression sickness can lead to permanent disability or death.



## ⚠ Warning

Do not pump nitrox mixtures at pressures above the HP compressor manufacturer's rating, and never above 3600 psi (250 bar). The system is not rated for pressures above 3600 psi (250 bar). Higher pressures may lead to explosions which may cause serious personal injury or death.

## ⚠ Caution

Ambient room temperature should never exceed 104° F (40° C) during operation of the nitrox system. Operation at higher temperatures may lead to system damage and malfunction. A damaged membrane will not produce the correct nitrox mixture which can lead to severe personal injury if the gas is used for diving purposes without proper analysis.

### Warnings Graphics Defined:



Moving belts



Electrocution



Fire

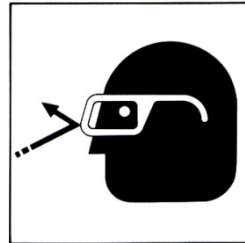

Eye protection



Gas inhalation



Skin damage

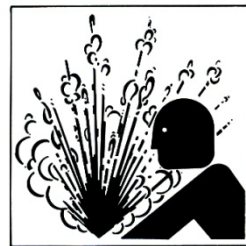

Explosion



Explosion



Electrocution

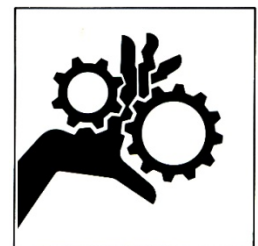

Machinery

### Abbreviations commonly used in this manual:

psi Pounds Per Square Inch  
 HP High Pressure  
 LP Low Pressure  
 O<sub>2</sub> Oxygen  
 CO Carbon Monoxide  
 CO<sub>2</sub> Carbon Dioxide  
 N<sub>2</sub> Nitrogen

CFM  
 RPM  
 PPM  
 L/min  
 O<sub>2</sub>%  
 B.P.

Cubic Feet per Minute  
 Rotations per Minute  
 Parts per Million  
 Liters per Minute  
 Oxygen Percentage of Gas  
 Back Pressure

## 3.0 Safety And Operation Precautions

Because a compressor is a piece of machinery with moving and rotating parts, the same precautions should be observed as with any piece of machinery of this type where carelessness in operations or maintenance is hazardous to personnel. In addition to the many obvious safety precautions, those listed below must also be observed:

- 1) Read all instructions completely before operating any compressor or nitrox system.
- 2) For installation, follow all local electrical and safety codes, as well as the National Electrical Code (NEC) and the Occupational Safety and Health Administration (OSHA) standards.
- 3) Electric motors must be securely and adequately grounded. This can be accomplished by wiring with a grounded, metal-clad raceway system to the compressor starter; by using a separate ground wire connected to the bare metal of the motor frame; or other suitable means.
- 4) Protect all power cables from coming in contact with sharp objects. Do not kink power cables and never allow the cables to come in contact with oil, grease, hot surfaces, or chemicals.
- 5) Make certain that power source conforms to the requirements of your equipment.
- 6) Pull main electrical disconnect switch and disconnect any separate control lines, if used, before attempting to work or perform maintenance. "Tag Out" **and** "Lock Out" all power sources.
- 7) Do not attempt to remove any parts without first relieving the entire system of pressure.
- 8) Do not attempt to service any part while system is in an operational mode.
- 9) Do not operate the system at pressures in excess of its rating.
- 10) Do not operate compressor at speeds in excess of its rating.
- 11) Periodically check all safety devices for proper operation. Do not change pressure setting or restrict operation in any way.
- 12) Be sure no tools, rags or loose parts are left on the nitrox system.
- 13) Do not use flammable solvents for cleaning the air inlet filters or elements and other parts.
- 14) Exercise cleanliness during maintenance and when making repairs. Keep dirt away from parts by covering parts and exposed openings with clean cloth or Kraft paper.
- 15) Do not operate the compressor without guards, shields, and screens in place.
- 16) Do not install a shut-off valve in the compressor discharge line, unless a pressure relief valve, of proper design and size, is installed in the line between the compressor unit and shut-off valve.
- 17) Do not operate this compressor in any location where there is a possibility of carbon monoxide (CO), carbon dioxide (CO<sub>2</sub>), nitrogen (N), or any flammable or toxic fumes being sucked into the compressor intake.
- 18) Be careful when touching the exterior of a recently run electric, gasoline, or diesel motor - it may be hot enough to be painful or cause injury. With modern motors this condition is normal if operated at rated load - modern motors are built to operate at higher temperatures.
- 19) Inspect unit daily to observe and correct any unsafe operating conditions found.
- 20) Do not "play around" with compressed air, or direct air stream at body, because this can cause injuries.
- 21) Compressed air from this machine absolutely must not be used for food processing or breathing air without adequate downstream filters, purifiers and controls and periodic air quality testing.
- 22) Always use an air pressure-regulating device at the point of use, and do not use air pressure greater than marked maximum pressure.
- 23) Check hoses for weak or worn conditions before each use and make certain that all connections are secure.

The user of any compressor or nitrox system manufactured by NuVair is hereby warned that failure to follow the preceding Safety and Operation Precautions can result in injuries or equipment damage. However, NuVair does not state as fact or does not mean to imply that the preceding list of Safety and Operation Precautions is all-inclusive, and further that the observance of this list will prevent all injuries or equipment damage.



#### **4.0 Legal Precautions**

It is highly recommended that a nitrox fill log be maintained when filling SCUBA cylinders to document the following information. This log must be of permanent binding style with no loose pages.

- Fill date and time of day
- Tank Serial Number
- Supplier's check of oxygen content (%O<sub>2</sub>) plus signature and date
- User's check of oxygen content (%O<sub>2</sub>) plus signature and date
- Fill Pressure
- MOD (Maximum Operating Depth) in user's handwriting
- Nitrox certifying agency and card number

## 5.0 Theory of Operation

The LP600 ME nitrox Generator system is a system that produces oxygen-rich air (nitrox) ready for delivery to a High Pressure (HP) compressor to fill SCUBA tanks or storage cylinders. The package is designed to be fully automatic with an operator overseeing the production to maintain proper nitrox mixtures not to exceed 40% oxygen. Although it is described as the “nitrox compressor”, it can also be used to pump air.

The nitrox system allows for efficient and cost effective nitrox production using electric power, without the hazards or expense of blending with stored high-pressure oxygen (O<sub>2</sub>). Instead, the system uses a semi-permeable membrane to produce nitrox from air. A portion of the nitrogen in air is separated out, leaving an oxygen rich nitrox mixture.

The LP600 ME nitrox Generator™ uses a rotary screw LP compressor, air / oil aftercooler, refrigerated air dryer, and filtration to provide the membrane system with a source of clean, pressurized feed air for separation. The air is filtered to CGA Grade D or better air quality prior to entering the membrane system so it will not damage or plug the membrane fibers. Specifications for Grade D air are provided in the appendix.

The LP600 ME nitrox Generator membrane system is rated for a maximum feed air pressure of 300 psi (21 bar) and has been configured to work well with the 175 psi (12 bar) maximum pressure delivered by the LP compressor. A back-pressure regulator is used to adjust the amount of air the screw compressor produces to meet the appropriate levels for various O<sub>2</sub>% nitrox production. The air is then heated to a temperature that provides stability over a wide range of ambient conditions, is optimal for membrane permeation, and prevents moisture condensation.

The heated air enters the membrane, which is made up of thousands of miniature hollow fibers. The walls of these fibers are semi-permeable and designed for different gases to move through them (or permeate) at different speeds. The resulting gas mixture is known as the “permeate.” As air flows through the hollow fibers, both oxygen and nitrogen permeate through the fiber walls. The oxygen permeates faster than the nitrogen, which produces permeate with oxygen content greater than air. The gas that reaches the end of the hollow fibers without permeating is almost entirely nitrogen and is discharged. The flow rate of this discharge is set by the factory via a fixed orifice, which controls the permeate.

The permeate is a concentrated mixture that is diluted with air prior to entering the HP compressor. It exits the membrane at ambient to slightly negative pressure and travels into the mixing tube, where it mixes homogeneously with filtered outside air. The amount of dilution, and thus final O<sub>2</sub>%, is obtained by adjusting the amount of air produced by the compressor and supplied to the membrane, with the back pressure regulator. As air flow to the membrane is increased, permeate flow increases and a higher O<sub>2</sub>% nitrox is produced. As air flow to the membrane is decreased, permeate flow decreases, compressor intake air increases, and a lower O<sub>2</sub>% nitrox is produced.

This relationship between permeate flow and intake air flow exists because the total of these two flow rates will always equal the intake flow rate demanded by the HP compressor. The resulting nitrox mixture is analyzed for O<sub>2</sub>% before entering the HP compressor for approximate content and again when pumping nitrox for precise content. The HP compressor pumps the nitrox to a maximum pressure of 3600 psi (250 bar) to fill SCUBA tanks or storage cylinders.

A unique feature of Nuair nitrox systems is that the feed air pressure that correlates to a specific nitrox O<sub>2</sub>% is repeatable. For example, if your HP compressor pumps 36% O<sub>2</sub> when the feed air pressure is at 125 psi (9 bar), then adjusting the back pressure regulator to 125 psi (9 bar) during the next use will produce the same mixture.

**6.0 Low Pressure Rotary Screw Compressor Technical Data**

EK76

- Capacity and Power Consumption:
- Normal operating pressure 100-175 psi (12 bar)
- Capacity at 175 psi 57 CFM (1614 L/min)
- Maximum operating pressure of system 175 psi (12 bar)
- Minimum operating pressure 73 psi (5 bar)
- Transmission Belt drive
- Cooling
- Allowed ambient temperature 32-104°F (0-40°C)
- Motor and electrical values
- Motor - F class, IP55 15 hp (11.2 kW)
- Compressor current
  - 208-230 V / E3 / 60 Hz 63 A
  - 380-415 V / E3 / 50 Hz 29 A
  - 440-480 V / E3 / 60 Hz 29 A
- Control voltage 230 V
- General technical data
- Oil Quantity 4 liters
- Oil Content 3 mg/m<sup>3</sup>

 **Notice**

Rotary screw compressors are continuous duty rated. They are not made to run for short intervals or sit without use for long periods of time. The rotary screw compressor must be run for a minimum of one continuous hour per week in tropical settings to insure moisture does not build up in the compressor. The oil filter, pre-filter and oil/air separator must be changed every 2000 hours or a minimum of once per year. In tropical conditions the oil should be checked every month for moisture by draining a small amount off the bottom of the compressor into a clear glass. If moisture is found it can be drained off and a visual inspection should be done on all filters checking for rust or corrosion.

## 7.0 System Components

- Low pressure rotary screw compressor
- Nuvair 546 food grade rotary screw compressor lubricant
- Seawater / oil / air / heat exchangers
- Refrigerated air dryer
- Frequency drive
- On/off flow valve
- LP compressor output regulator with pressure gauge:
- Adjusted pressure output 100-175 psi (7-12 bar) depending on nitrox O<sub>2</sub>%
- Low pressure filtration, grade D breathing air, including three stages:
  - Coalescing & Particle Removal to 1 micron, auto drain, differential pressure indicator
  - Water & oil vapor removal to 0.01 micron, auto drain, differential pressure indicator
  - Oil vapor removal to 0.003 PPM, manual drain
- Heater including:
  - Thermostat control
  - Digital temperature gauge
  - Pressure switch
- Semi-permeable membrane – compatible with HP compressors rated up to 34 CFM (963 L/min)
  - FAD for 40% O<sub>2</sub> 21 CFM (600 L/min)
  - FAD for 36% O<sub>2</sub> 26.5 CFM (750 L/min)
  - FAD for 32% O<sub>2</sub> 36 CFM (1018 L/min)
- Mixing tube & air intake filter
- Nuvair Pro O<sub>2</sub> Remote™ panel mount inline oxygen analyzer
- Compressor intake hose for nitrox compressor
- Nitrogen discharge hose (optional)
- Nuvair Pro O<sub>2</sub>™ Fill Oxygen Analyzer, including:
  - High pressure>low pressure regulator
  - Flow restrictor, 1 - 5 L/min
- Nitrox compressor lubricant:
  - Nuvair 455 Food Grade Lubricant (standard)
  - Nuvair 751 Diester Based Lubricant (optional)
- Air/nitrox quality analysis kit

**8.0 Nitrox System Specifications**

<b>Nuvair Nitrox Generator Model</b>		<b>LP600</b>
<b>Physical Specifications</b>	<b>Height</b>	40.5 in (103 cm)
	<b>Width</b>	29.5 in (75 cm)
	<b>Length</b>	45.5 in (116 cm)
	<b>Weight</b>	570 lb (259 kg)
<b>Electrical Specifications</b>	<b>Full Load Amps</b>  208-230 V / E3 / 60 Hz 380-415 V / E3 / 50 Hz 440-480 V / E3 / 60 Hz	63 Amps 29 Amps 29 Amps
<b>Membrane Input</b>	<b>Operating Pressure Range</b>	100-175 psi (7-12 bar)
	<b>Maximum Input Pressure</b>	300 psi (21 bar)
	<b>Supply Air Volume Range</b>	13-60 SCFM (368-1699 L/min)
	<b>LP Supply Air Quality</b>	Grade D
	<b>Optimum Temperature</b>	110 +/- 5°F (43 +/- 3°C)
	<b>Nitrox O<sub>2</sub>% Range</b>	24 - 40%

9.0 Component Identification



Refrigerated Air  
Dryer

Condensate Drain

Pre-filter for Dryer

# LP600 Water Cooled Marine Nitrox Generator

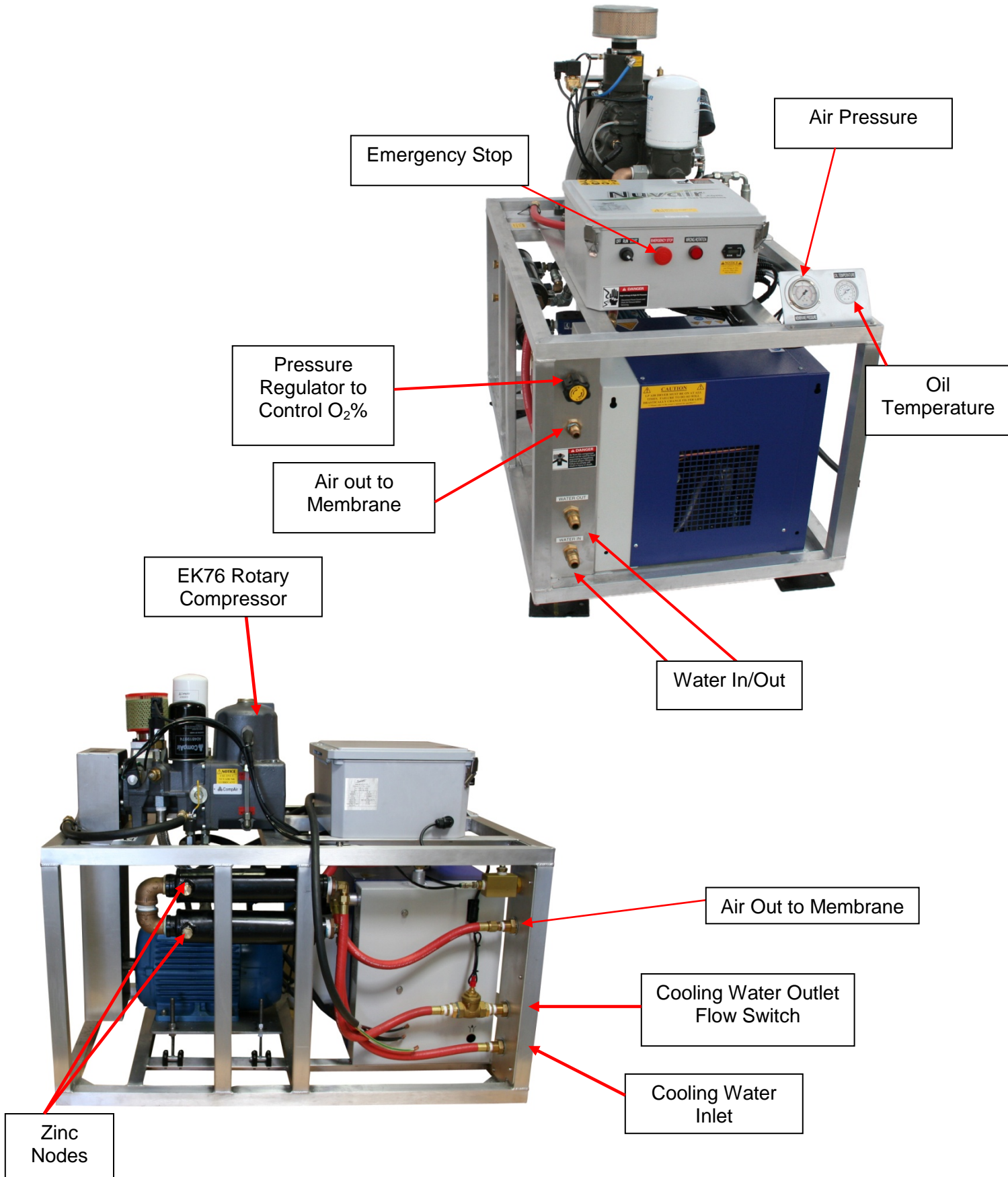

# LP600 Water Cooled Marine Nitrox Generator

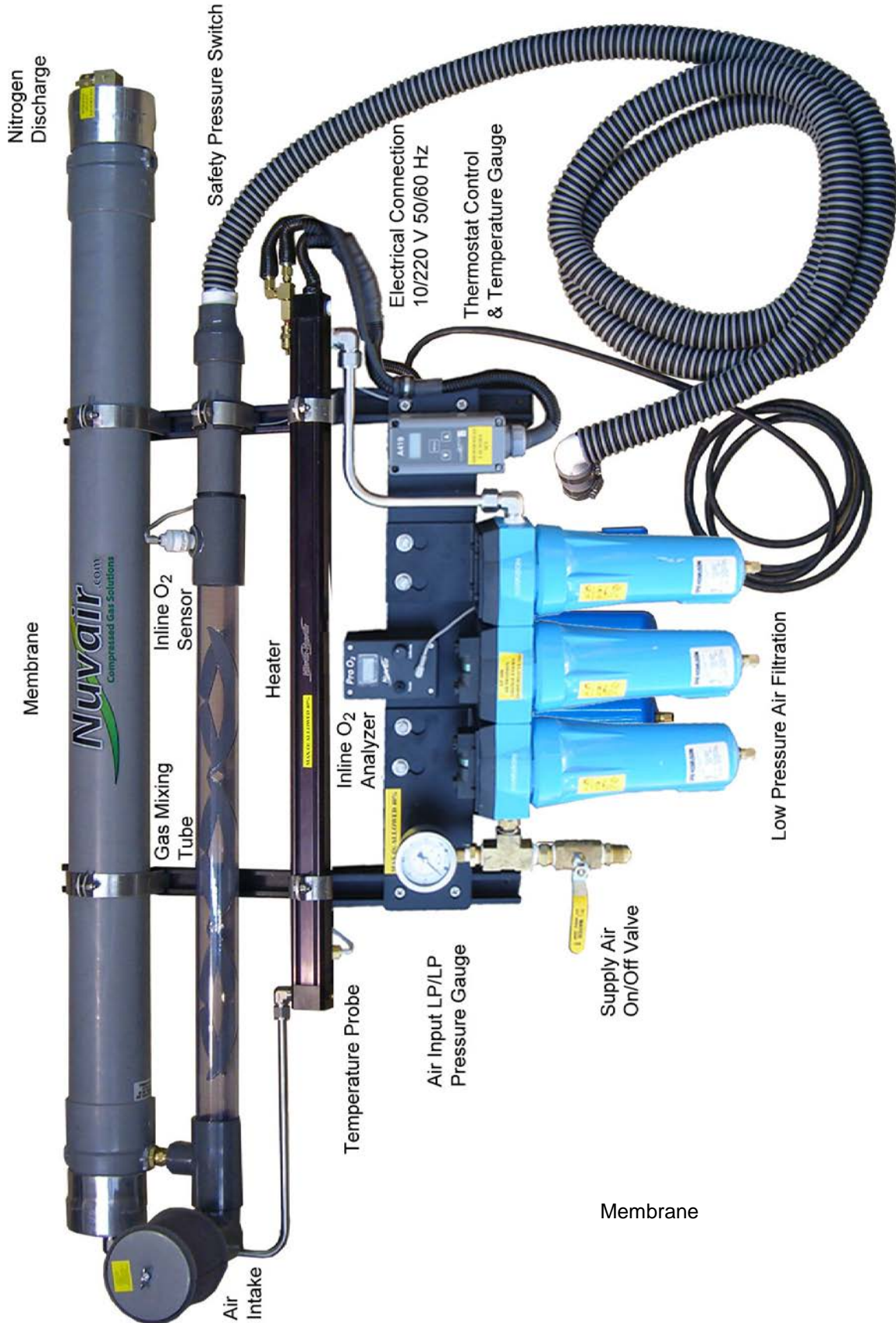



10.0 System Drawing / Schematic

LP600 Nitrox Generator  
System Components Shown  
Within Dashed Lines

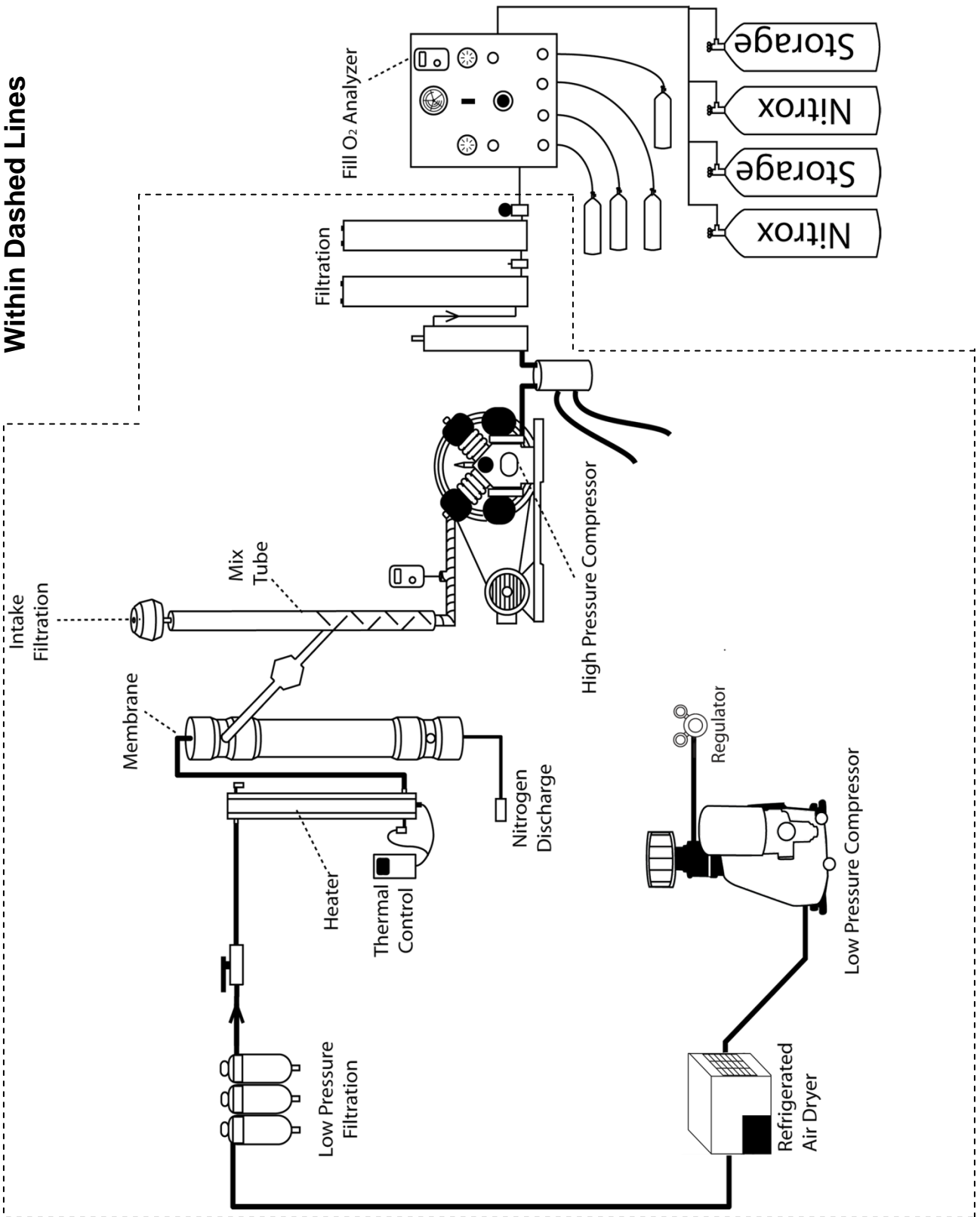

11.0 System Flow Chart

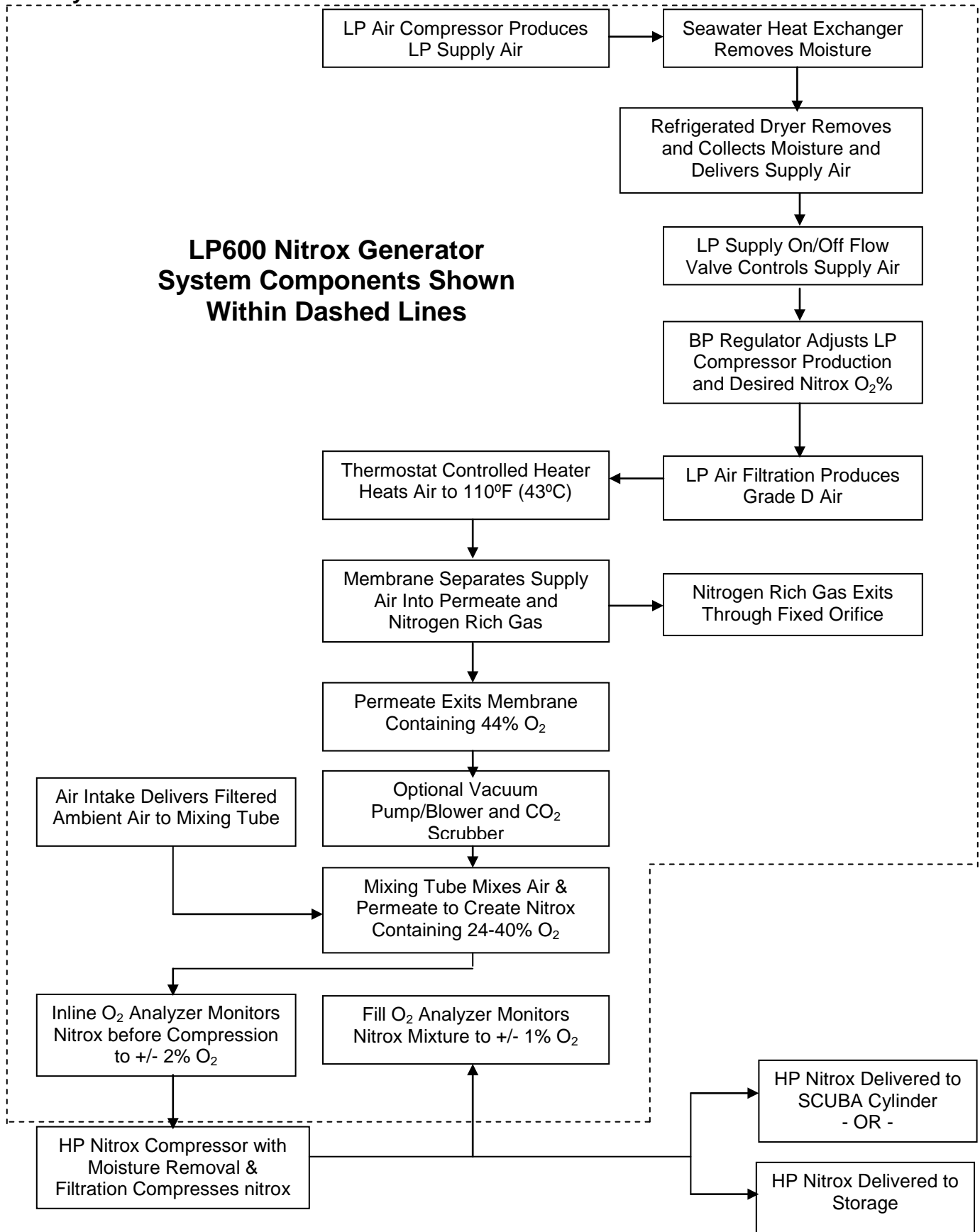

## 12.0 Preparing Existing HP Compressors



### Warning

Some compressors are not suitable for compressing oxygen-rich air, i.e., nitrox. Use of an unsuitable compressor may lead to possible compressor damage and/or fires or explosion. This can lead to serious personal injury or death. If there is any doubt regarding the use of an existing compressor, contact Nuvair or the compressor manufacturer before you connect your nitrox system to your machinery.

### 12.1 Purification System

The purification system on the existing HP compressor to which the nitrox system will be installed must produce Grade E, DIN 3188, EN 12021, CGA E and CSA breathing air appropriate for diving use. This is the same standard applied to all breathing air compressors. Please make sure you place extra caution on timely replacement of the filters in the purification system to ensure these standards at all times. Specifications for Grade E air, DIN 3188, EN 12021, CGA E and CSA are provided in the appendix.

A recent air quality test from your existing Compressor is highly recommended prior to installing the nitrox System. After installation, test a nitrox sample using the Air/nitrox Quality Analysis Kit provided. Quarterly testing is mandatory once the System is operational.

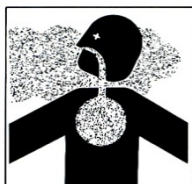

### Caution

Breathing air compressors must produce breathing air appropriate for diving use in accordance with the appropriate CGA Grade. Periodic air quality testing is mandatory to assure compliance.

### 12.2 Replacement of Compressor Lubricant

For an existing Compressor to be used with the Membrane System, all traces of old Lubricant must be removed and replaced with nitrox Compressor Lubricant. Nitrox Compressor Lubricant is compatible with both air and nitrox.

- 1) Start Compressor and run for 10 minutes to warm Compressor Lubricant. Shut off Compressor, remove Lubricant, and replace Lubricant Filter if any.
- 2) Refill Compressor with the Nuvair Air/Nitrox Compressor Lubricant supplied. Do not overfill.
- 3) After 10 hours, repeat Steps 1 and 2.



Nuvair 455  
Food Grade Air &  
nitrox Compressor  
Lubricant (Standard)



Nuvair 751  
Diester Based Air &  
nitrox Compressor  
Lubricant (Optional)



### Warning

Any oil spilled during the oil and oil filter change could cause personnel to slip and fall. Wear anti-slip footwear. Remove any traces of spilled oil immediately. Slips and falls may cause severe personal injury or death.



### Warning

Do not carry out any maintenance tasks if the compressor has just shut down. Wait for the compressor to cool to avoid skin burns.

### Notice

For an existing Compressor to be used with the Membrane System, all traces of old Lubricant must be removed and replaced with nitrox Compressor Lubricant. Recommended nitrox compressor lubricant change intervals after the 10-hour flush are at 25, 50, and 100 hours. After reaching 100 hrs, change lubricant in 100 hour cycles.

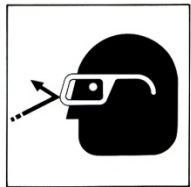

### Caution

Wear eye protection, gloves, and skin protection when performing oil changes. Although the oil is not classified as a dangerous substance, the oil can be irritating to your eyes and skin.



### Warning

Use only the specified Nuvair lubricants in this system. The use of incompatible lubricants presents a risk of fire and/or explosion, and may result in system damage. This can lead to severe personal injury or death.

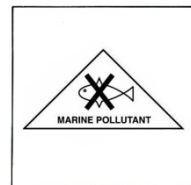

### Caution

Both oil and oil filter are classified as “special wastes” and must be disposed of properly according to applicable national and local laws. Failure to dispose of these wastes properly can lead to death of wildlife as well as government fines and penalties.

## 12.3 Installation of Fill Oxygen Analyzer

The Fill Oxygen Analyzer is installed at the final nitrox outlet (compressor fill whip, Fill Panel, etc.) to monitor oxygen content. A sample stream of nitrox is delivered to the analyzer to provide accurate results and prevent damage to the analyzer. A regulator and flow restrictor are used to control the pressure and flow of the sample stream. After installation, always use the Fill Oxygen Analyzer when pumping either nitrox or air to ensure proper oxygen content.

### Warning

Never expose the oxygen analyzer sensor to pressures other than ambient or you may damage it and/or cause false readings. A damaged sensor will not provide accurate gas analysis. Inaccurate gas analysis can lead to serious personal injury or death when the gas mixture that was analyzed is used for breathing.

## LP600 Water Cooled Marine Nitrox Generator

The nitrox sample stream is obtained at the Fill Whip location on the Compressor or Fill Panel. Tap into the Fill Whip manifold or install a HP “T” fitting, then attach the inlet of the Regulator/Flow Restrictor Assembly using HP hose and fittings as required (hose and fittings not included). Mount the Fill Oxygen Analyzer in a secure location, then attach the outlet of the Regulator/Flow Restrictor Assembly to the Analyzer using the hose provided.

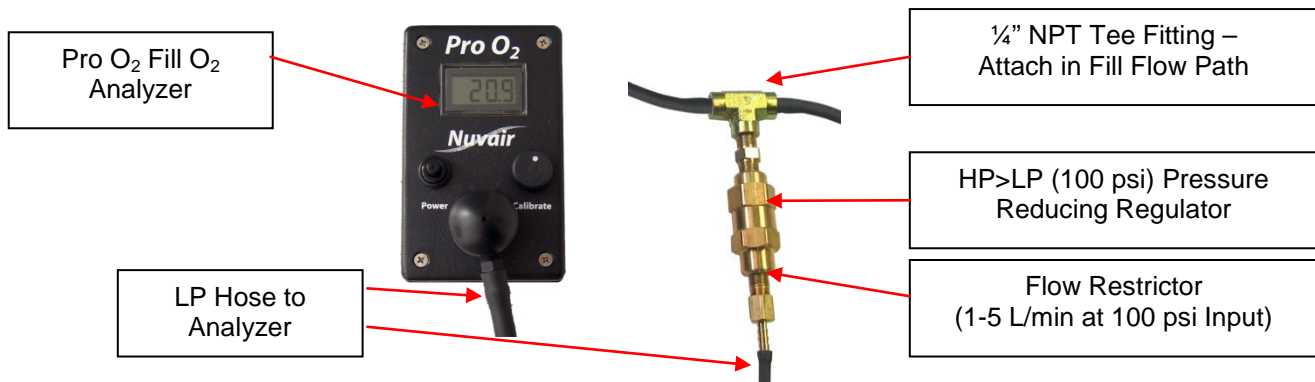

### 13.0 Installing the nitrox System

#### Notice

If any information in these manual conflicts with any of the other manuals provided, call our headquarters at +1 805 815 4044 before proceeding.

#### 13.1 Precautions

- 1) Please read all information supplied before physically installing the nitrox System.
- 2) Unpack the system and remove from the pallet. Visually inspect the system to make sure there has been no damage during shipping. If damaged, please call Nuvair to file a damage report. Please take photos and supply detailed information about the damage.
- 3) Place the system in a permanent location near the existing HP Compressor. Allow a minimum spacing of 18" from adjacent walls. Select a location where ambient room temperature will never exceed 100°F (38°C).
- 4) The Heater Thermostat has been set in the factory. Do not adjust.
- 5) A 13 foot corrugated Compressor Intake Hose has been provided to connect the nitrox System to the HP Compressor intake. If a longer hose is required, the diameter must also be increased. Contact Nuvair for assistance.

#### Caution

Do not use a compressor Intake hose longer than 13 feet to connect the nitrox generator to the compressor intake. Use of a longer hose will increase the amount of suction the compressor must generate which can cause overheating and damage to the compressor. Damaged compressors can pump impurities into the diver's breathing gas.

#### Caution

Do not substitute a compressor intake hose of a smaller diameter than the supplied by Nuvair. Use of a smaller diameter hose will increase the amount of suction the compressor must generate which can cause overheating and damage to the compressor. Damaged compressors can pump impurities into the diver's breathing gas.

### 13.2 Attaching Compressor Intake Hose

- 1) Cut the Intake Hose to proper length to reach between the Nitrox System and HP Compressor. Reattach end fittings
- 2) Attach the Intake Hose to the Nitrox System outlet.
- 3) Attach the other end of the Intake Hose to the intake of the Nitrox Compressor and secure with the hose clamp provided.

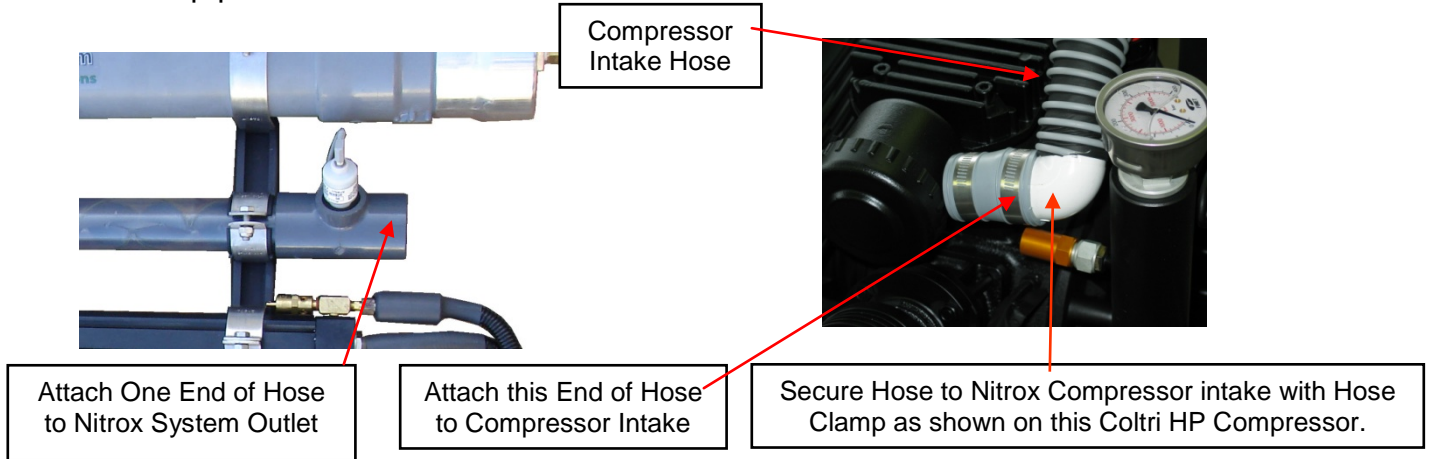

### 13.3 Attaching Nitrogen Discharge Hose (Optional)

The nitrogen discharge from the Membrane must be isolated from the air intakes of the Membrane System and LP Compressor. This requirement will be met if the nitrox System is installed in a well-ventilated room that meets industry standards for Compressor installations. If the nitrox System is installed in a closed building, boat, or similar enclosed space, the nitrogen discharge must be vented to the outside. An optional Nitrogen Discharge Hose may be needed. If your installation requires the use of a Nitrogen Discharge Hose, please contact Nuair for assistance.



#### **Warning**

Pure nitrogen is a colorless, odorless, tasteless gas that will not support life. Breathing gas mixtures containing more than 84% nitrogen at surface pressures will lead to unconsciousness and may cause death.



#### **Warning**

The nitrogen discharge from the membrane should be vented to a well-ventilated room or to open air with good circulation. Failure to isolate the discharge from the air intake of the membrane system or LP compressor could lead to incorrect nitrox mixtures, resulting in serious personal injury or death. If you allow this pure nitrogen to accumulate in an enclosed space, anyone entering this space will quickly lose consciousness and will die if not immediately resuscitated.

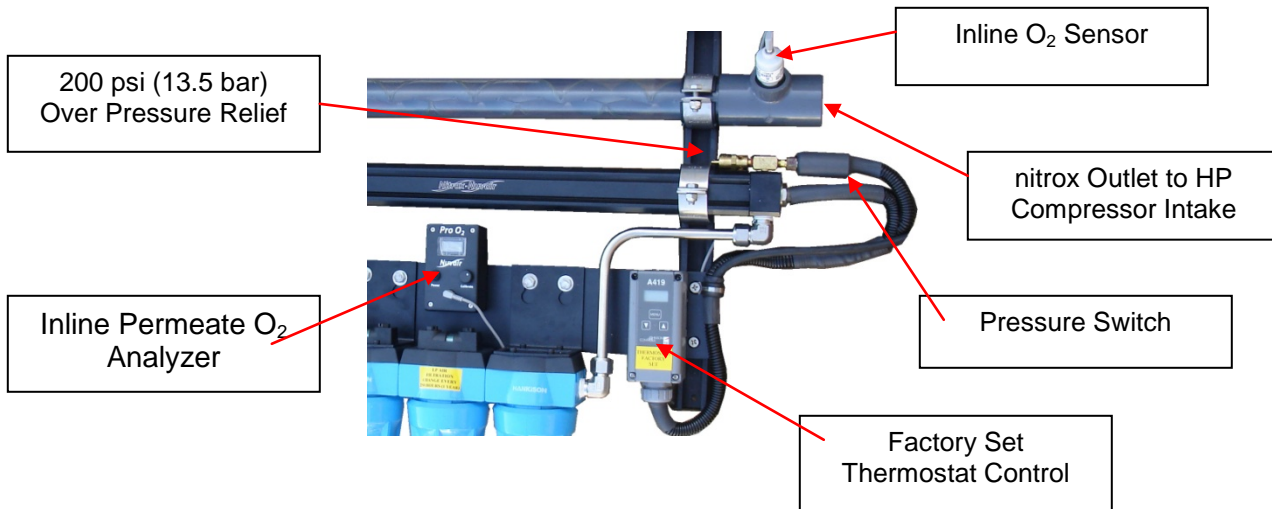

## 13.4 Output Pressure Adjustments

The LP compressor output is adjusted with the feed air (B.P.) regulator located on top. The feed air (B.P.) regulator can be used to adjust the output pressure from 100-175 psi (7-12 bar).

This output adjustment allows the system to be used with a HP compressor having a rated capacity up to (see page12). If your HP compressor is smaller, the inlet pressures required for the membrane system may be lower.

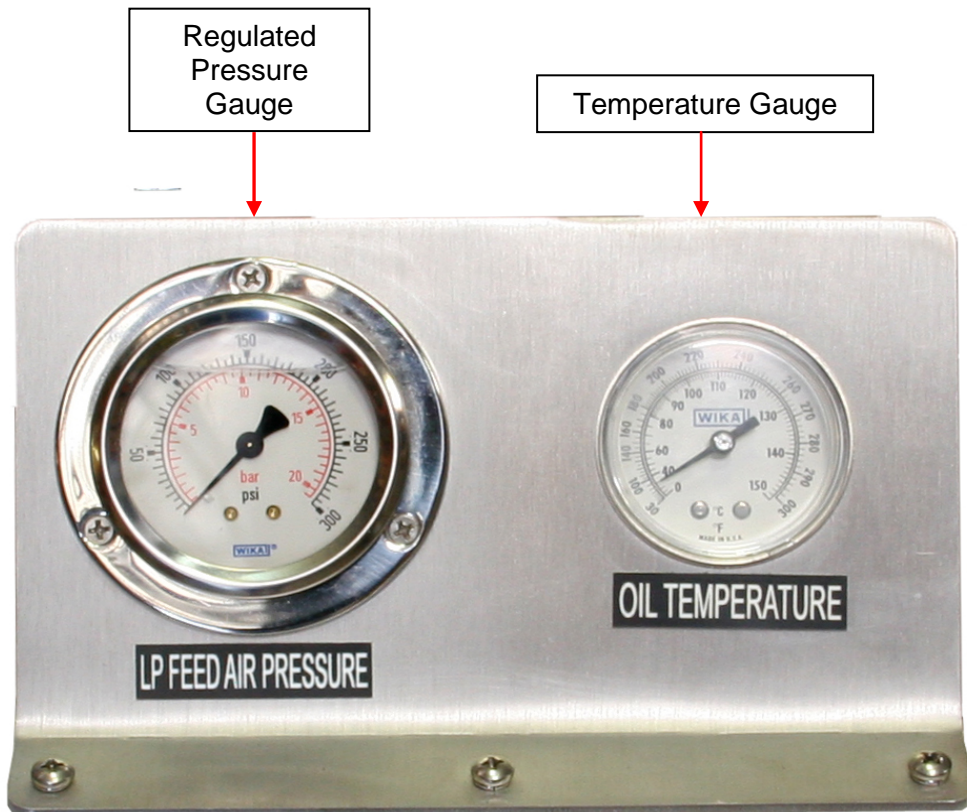

## 13.5 Electrical Power Connection

Electrical wiring and connections should be made by a qualified electrician in accordance with all national and local electrical codes. Check all system specifications provided in this manual. Do not use extension cords.

Proper rotation of motor fan

### Amperage Load for System

- ◆ Approximately 63 A for 208- 230 V three phase service
- ◆ Approximately 29 A for 380-415 V three phase service
- ◆ Approximately 29 A for 440-480 V three phase service

### LP Compressor Rotation Check

Always turn on (bump) starter and run motor very briefly to check for proper direction of rotation. Watch that the Rotation light on the Control box is not lit.

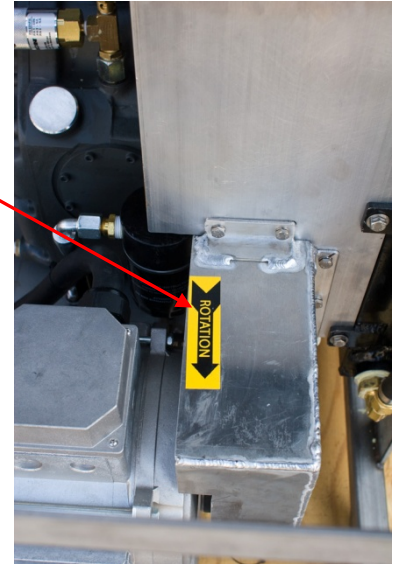

## ⚠ Notice

Operation in reverse direction for extended periods of time will cause a reciprocating compressor to run hot and perform poorly and may cause permanent damage. Reverse rotation for a rotary screw compressor for even a short period of time will cause damage.



## ⚠ Warning

Never use extension cords to provide power to your nitrox system. The system must be properly wired according to national and local electrical codes by a qualified electrician. Improper wiring may lead to fires, which can cause serious personal injury or death.

Store the compressor with the power switch in the off position. **When working on the compressor the main breaker at the power source must be "locked out" and "tagged out" in the "Off" position.**

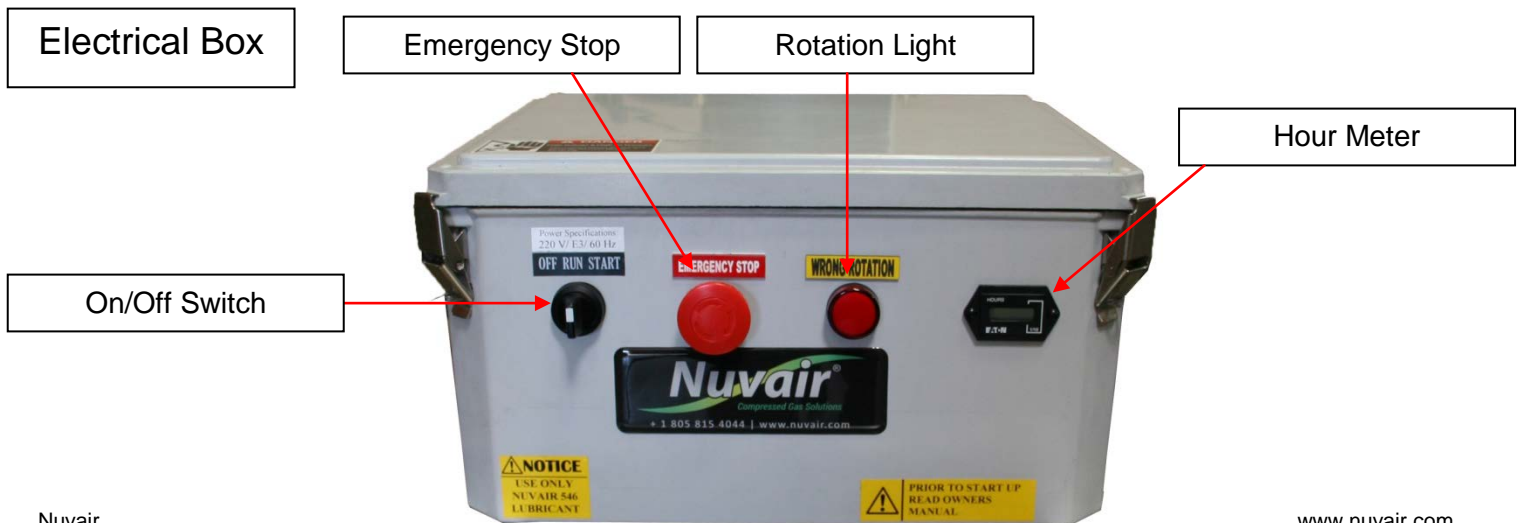



## 13.6 Refrigerated Air Drier

1. It is best to leave the drier on at all times. If your application requires turning the drier off when not in use. Turn the dryer on at least 1 hour before use.
2. Check that during operation the temperature gauge is operating. The yellow light is power on and the red means that too much heat is being made.
3. Listen for the solenoid valve opening and draining condensate every 5 minutes or less.



## 13.7 Air/nitrox Quality Testing

Before using your nitrox system to pump nitrox, test a sample of the nitrox produced using the air/nitrox quality analysis kit provided to verify compliance with CGA standards. Quarterly testing is mandatory once the system is operational.

Air/nitrox Quality Analysis Kit



## 14.0 Pre-Operation Instructions

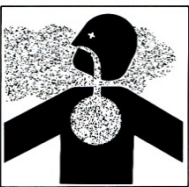

### Warning

Do not allow nitrox to be discharged into the air storage system. Nitrox introduced into the air storage system could cause a diver to suffer from oxygen poisoning at depth. Oxygen poisoning is extremely dangerous and can lead to death by drowning.

### Warning

Do not allow air to be discharged into the nitrox storage system. Air introduced into the nitrox storage system could cause a diver to suffer decompression sickness if the nitrox mixture is not analyzed properly and is used underwater under the assumption it is a different mix.

## 14.1 Compressor Lubricant Levels

Check lubricant levels before starting the LP and HP compressors, and add lubricant as required. Use only the lubricants specified. (See Section 17.3 for Lubricant Change and Hours)

## 14.2 Membrane System O<sub>2</sub>% Control Knob and Flow Valve

A low pressure feed air (B.P.) regulator is used to reduce supply pressure to the membrane system to a typical range of 90–175 psi (6-12 bar) An On/Off supply valve is used to control the flow of LP supply air into the membrane system. Prepare the membrane system as follows:

- 1) Reduce input pressure to minimum pressure setting by turning the (B.P.) regulator adjustment regulator knob counter-clockwise (CCW) until it spins freely.
- 2) Turn (B.P.) regulator knob clockwise (CW) until you first feel resistance, which means that the spring is starting to compress.
- 3) Make sure the feed air On/Off supply valve is in the off position.

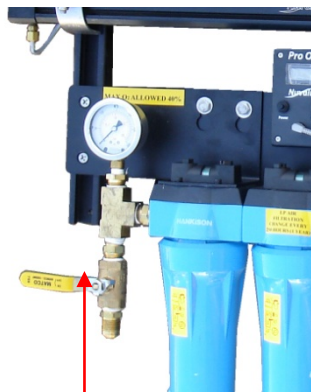

On/Off Air Flow  
Ball Valve  
Pictured in off position

LP Feed Air  
(B.P.) Regulator  
Variations



### 14.3 Oxygen Analyzer Calibration

Gas production must be monitored with the permeate inline oxygen analyzer before the compressed gas enters the HP compressor to obtain a rough estimate of O<sub>2</sub>% (+/- 2%). Do not rely on this reading as a proper indication of O<sub>2</sub>% at the HP compressor outlet. Prior to pumping nitrox from the compressor, it must be monitored with the fill oxygen analyzer to obtain a precise measurement of O<sub>2</sub>% (+/- 1%). **Both oxygen analyzers must be calibrated prior to each use.**

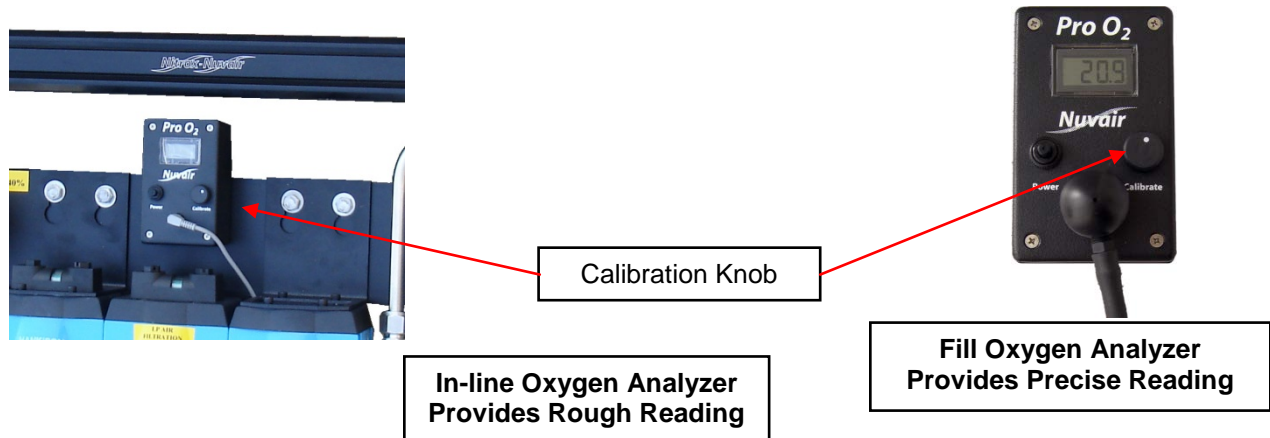

### Warning

Oxygen analyzers must be calibrated before each use. See oxygen analyzer manuals for correct calibration procedures. Improper calibration of the fill oxygen analyzer may result in the use of incorrect nitrox mixtures, which may cause serious injury or death to the diver using the gas mixture.

### Warning

At altitudes above sea level, a correction factor must be used when calibrating the fill oxygen analyzer. It may not be possible to achieve all desired mixtures at altitude. See fill oxygen analyzer manual for correcting analyzer readings at various altitudes. Improper calibration of the fill oxygen analyzer may result in the use of incorrect nitrox mixtures, which may cause serious injury or death to the diver using the gas mixture.

### Warning

The permeate (in-line) oxygen analyzer supplies oxygen readings that can vary +/- 2% O<sub>2</sub> due to heat, humidity, and pressure changes experienced in the nitrox flow and therefore should only be used for rough estimates of oxygen percentage. The fill oxygen analyzer supplies more accurate oxygen readings, within +/- 1% O<sub>2</sub>. For cylinder nitrox fills, the user must always verify with a third independent Oxygen Analyzer.

### Calibrate Oxygen Analyzers as Follows:

- 1) Turn on the high pressure compressor and allow pressure to build to approx 2000 psi.
- 2) Open a pressure relief at the outlet so that the running HP compressor maintains 1500-2000 psi (100-136 bar) outlet pressure.
- 3) Power on and calibrate the oxygen analyzers while the HP compressor is pumping air. Refer to the inline oxygen analyzer manual included with the nitrox system for details. Note that special calibration procedures may be required when operating at altitudes above sea level.  
**Fill oxygen analyzer** –Refer to manual provided with fill analyzer
- 4) Turn on the nitrox generator and increase pressure at the BP regulator until the feed air pressure exceeds 100 psi, activating the nitrox membrane heater.
- 5) Allow both compressors to run for approx 10 minutes while the membranes warm up and stabilize. Check the heater temperature gauge to verify air temperature rises and is between 105-120 °F (40-49 °C).

Now that the system temperature has stabilized, you must recalibrate the fill O<sub>2</sub> analyzer following the instructions laid out in the fill analyzer manual.

### Notice

The oxygen analyzers may require recalibration after 10-20 minutes of operation due to humidity and temperature change effects on the sensor. To recalibrate, turn off the LP feed air and follow calibration instructions.

## 14.4 Filling SCUBA Cylinder

### Notice

High-pressure cylinders that are filled quickly will become hot and due to the increased internal temperature the cylinder pressure will increase. This will leave a diver with less pressure inside the cylinder once cooling has occurred. This will decrease the amount of time the diver may spend underwater which may be critical during a deep dive. Customers must be warned of this possibility if cylinders are delivered for use while warm. Always fill all breathing gas cylinders slowly to avoid overheating.

## 15.0 Producing Nitrox

Before using your nitrox generator to pump nitrox, test a sample of the nitrox produced using the air/nitrox quality analysis kit provided to verify compliance with CGA standards or applicable standards for intended use. Quarterly testing is mandatory once the system is operational.

### Warning

The equipment you will be using to manufacture nitrox (oxygen rich air) will expose you to both low and high-pressure gas. Gas, even under moderate pressures, can cause extreme bodily harm. Never allow any gas stream to be directed at any part of your body.

### Notice

Do not change the temperature setting on the thermostat control without contacting NuVair. Changes in temperature settings may cause membrane damage. A damaged membrane will not produce the correct nitrox mixture which can lead to severe personal injury if the gas is used for diving purposes without proper analysis.

### 15.1 Flow to Membrane

1. Verify that oxygen analyzer calibration is complete.
2. Check that On/Off feed (flow) valve is in the off position.
3. Turn on LP compressor using on/off switch and allow system to build up pressure until it unloads.
4. Turn on your HP compressor. Allow outlet pressure to build up to approximately 2300 psi, then crack open the unconnected fill whip to maintain 1500-2300 psi
5. Verify that inline oxygen analyzer reads 20.9%.
6. Turn on membrane system by slowly opening the on/off flow valve.
7. Adjust input pressure to approximately 100 psi to activate heater pressure switch. Increase pressure by slowly turning the regulator knob clockwise or decrease pressure by turning the knob counter clockwise.
8. Verify that heater thermostat control indicator light is on. The light will remain on until operating temperature is reached and will then cycle on and off. When light turns off, check heater temperature gauge to verify air temperature is between 105-120°F (40 - 49°C). Temperature is preset at the factory and changes to the thermostat control should not be required.

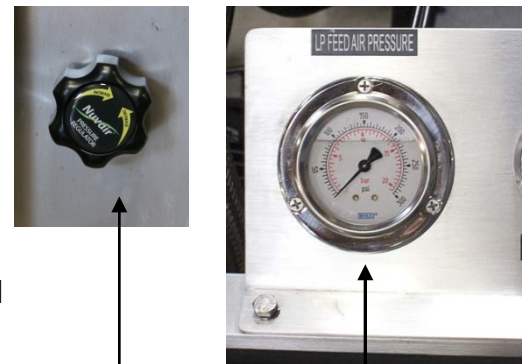

B.P. LP Regulator Adjustment Knob

Regulated Pressure Gauge

Heater Thermostat Control

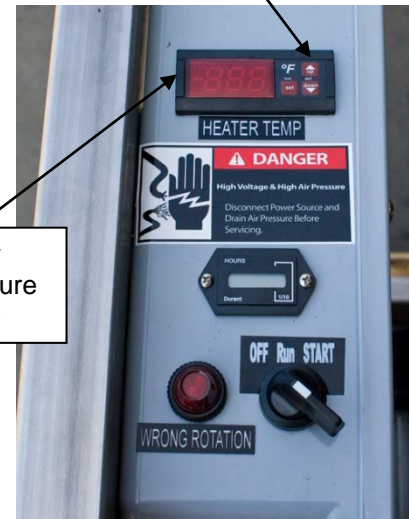

Heater Temperature Gauge

On/Off Flow Valve Handle in On Position



## **Caution**

The on/off flow valve on the nitrox membrane system must be opened slowly. A sudden rush of gas can damage the Membrane and other system components.

## **Notice**

The heater thermostat control green indicator light will stay on until operating temperature is reached.

## **Notice**

Do not change the temperature setting on the thermostat control without contacting Nuvair. Changes in temperature settings may cause membrane damage. A damaged membrane will not produce the correct nitrox mixture which can lead to severe personal injury if the gas is used for diving purposes without proper analysis.

### 15.2 Setting Proper Pressure

The membrane system feed air pressure determines the oxygen percentage of the nitrox mixture. As pressure is increased, a higher oxygen percentage of nitrox is pumped. As pressure is decreased, a lower percentage of oxygen is pumped.

- 1) Increase input pressure by slowly turning the back pressure regulator knob clockwise while monitoring the LP pressure gauge and inline oxygen analyzer. As the pressure rises, watch the corresponding increase in the analyzer O<sub>2</sub>% reading.
- 2) Increase or decrease pressure slowly until the inline oxygen analyzer displays the O<sub>2</sub>% desired in the final nitrox mixture.
- 3) Allow system pressure and temperature to stabilize (approximately 5-8 minutes).
  - ◆ Regulated membrane system pressure range should be 90–175 psi (6-12 bar), depending on nitrox O<sub>2</sub>% being produced.
  - ◆ Heater temperature range should be 105-120 °F (40-49 °C).



Inline Oxygen Analyzer



Regulated Pressure Gauge

### 15.3 Final Adjustments Before Pumping Nitrox

- 1) As the nitrox initially makes its way through the running HP compressor, the O<sub>2</sub>% reading on the fill oxygen analyzer will slowly increase to read approximately the same O<sub>2</sub>% as the inline oxygen analyzer. This should happen within 3-5 minutes.
- 2) When the two analyzers read within +/- 1%, make any final adjustments to the membrane system input (feed) air pressure necessary to obtain the exact nitrox O<sub>2</sub>% desired as indicated on the fill oxygen analyzer.
- 3) The system is now ready to pump nitrox.



Fill Oxygen Analyzer

### 15.4 Pumping Nitrox Warnings

#### Warning

The use of enriched air nitrox does not eliminate the risk of decompression sickness (DCS) in diving. Decompression sickness can lead to permanent disability or death.

#### Warning

The permeate O<sub>2</sub> analyzer supplies oxygen readings that can vary +/- 2% O<sub>2</sub> due to heat, humidity, and pressure changes in the nitrox flow and should only be used for rough estimates of O<sub>2</sub>%. The fill O<sub>2</sub> analyzer supplies more accurate readings, within +/- 1% O<sub>2</sub>. For SCUBA cylinder fills, the user must always verify the fill with a third independent O<sub>2</sub> analyzer.



#### Warning

Do not use this system to produce nitrox mixtures containing more than 40% oxygen. Pumping nitrox mixtures with higher concentrations of oxygen may lead to fires or explosions, which can cause serious personal injury or death.



#### Warning

Do not pump nitrox mixtures at pressures above the HP compressor rating, and never above 3600 psi (250 bar). The system is not rated for pressures above 3600 psi (250 bar). Higher pressures may lead to explosions which may cause serious personal injury or death.

#### Notice

No oxygen cleaning of standard cylinders or plumbing is mandatory when using the nitrox system to produce nitrox containing a maximum of 40% oxygen. When filling oxygen clean cylinders, hyper-purification of the nitrox is required using an optional oxygen compatible air purification system available from Nuvair.



**Warning**

This nitrox system does not produce nitrox mixtures acceptable for 100% oxygen service. Mixing nitrox mixtures with 100% pure oxygen may lead to fires and / or explosions, which may cause serious personal injury or death.



**Warning**

Never fill a cylinder that is marked, "For Oxygen Service," with nitrox that has been produced by anything other than 100% oxygen clean system. Filling an oxygen clean cylinder with breathing gas containing hydrocarbons can lead to explosions if the cylinder is subsequently filled with gas mixtures containing

gas mixtures containing greater than 40% oxygen. Explosions may cause serious injury or death.

**Warning**

Only provide SCUBA cylinder nitrox fills to customers who have proof of nitrox training and certification. Improper use of nitrox can cause severe personal injury or death.



**Danger**

This system is not cleaned for oxygen service and not all components are compatible with gas mixtures containing greater than 40% oxygen. Pumping gas mixtures containing greater than 40% oxygen will lead to explosions which may cause severe personal injury or death.

**Warning**

Each SCUBA cylinder belonging to a customer must be analyzed by that customer at the nitrox filling facility, using an oxygen analyzer independent of those used with the nitrox system. An employee must witness that the customer has properly analyzed the gas in each cylinder, noted the maximum operating depth for that mixture, and signed and dated the fill log. The time of day must also be included with the date, since some customers may fill the same cylinder more than once a day.

**Warning**

Each SCUBA cylinder belonging to a customer must be analyzed by that customer at the nitrox filling facility, using an oxygen analyzer independent of those used with the nitrox system. An employee must witness that the customer has properly analyzed the gas in each cylinder, noted the maximum operating depth for that mixture, and signed and dated the fill log. The time of day must also be included with the date, since some customers may fill the same cylinder more than once a day.



**15.5 Pump Nitrox as follows:**

Fill SCUBA cylinders or HP storage tanks as follows:

- 1) When filling a SCUBA cylinder, follow all industry standards. Do not exceed rated pressure of cylinder, and do not exceed 3600 psi (250 bar) under any condition.
- 2) With fill whip bleed valve open and nitrox flowing, verify that fill oxygen analyzer O<sub>2</sub>% reading equals the desired nitrox O<sub>2</sub>%.
- 3) Close bleed valve, open cylinder valve, and fill cylinder. While filling, monitor system for proper operation:
  - a) Monitor Oxygen Analyzers and recalibrate as required
  - b) Manually drain all Compressor condensate every 10-15 minutes and listen for proper operation of auto-drains if equipped.
  - c) Monitor all system gauges for recommended settings below.

**⚠ Notice**

The Oxygen Analyzers may require re-calibration after 10-20 minutes of operation due to humidity and temperature change effects on the sensor. To recalibrate, turn off the LP feed air switch and follow calibration instructions.

**⚠ Notice**

When the HP compressor auto drain engages and dumps condensate, the fill oxygen analyzer reading will decrease momentarily due to the pressure drop in the system. It will return to its previous reading within seconds after the auto drain sequence stops.

<b>GAUGE</b>	<b>RECOMMENDED SETTING</b>
<b>Compressor gauges</b>	According to manufacturers recommendations
<b>Heater Temperature</b>	104-120° F (40-49° C)
<b>Cabinet Temperature</b>	Less than 104 Degrees F (40 °C)
<b>Membrane Feed Air Pressure</b>	90 - 175psi (6-12bar) Depending on the Nitrox O <sub>2</sub> %
<b>Fill Oxygen Analyzer</b>	Showing the proper reading for intended fill
<b>Nitrox Storage Pressure</b>	<b>DO NOT</b> exceed rating of tank or 3600 P.S.I. (250Bar)

- 4) After filling is complete, close cylinder valve, vent the bleed valve, and remove the cylinder.
- 5) Test the nitrox O<sub>2</sub>% in the cylinder using an independent oxygen analyzer such as the Nuvair O<sub>2</sub> Quickstick. Calibrate analyzer before use in accordance with manufacturer's instructions.
- 6) Repeat steps 1-5 until you have filled all SCUBA cylinders.
- 7) Mark each tank with fill date, O<sub>2</sub>%, fill pressure, and MOD (Maximum Operating Depth) in user's handwriting.



Use Independent Oxygen Analyzer for Verification

- 8) Log every nitrox fill to document the following information:
- Fill date and time of day
  - Tank serial number
  - Supplier's check of oxygen content O<sub>2</sub>% plus signature and date
  - User's check of oxygen content O<sub>2</sub>% plus signature and date
  - Fill pressure
  - MOD (Maximum Operating Depth) in user's handwriting
  - Nitrox certifying agency and card number
- 9) When filling a HP nitrox storage tank, verify that fill oxygen analyzer O<sub>2</sub>% reading equals the desired nitrox O<sub>2</sub>%. Open applicable line valves and tank valve, and fill with nitrox. Do not exceed rated pressure of cylinder, and do not exceed 3600 psi (250 bar) under any condition. After filling is complete, close all valves and allow the nitrox system to shut down.

## Notice

High-pressure cylinders that are filled quickly will become hot and due to the increased internal temperature the cylinder pressure will increase. This will leave a diver with less pressure inside the cylinder once cooling has occurred. This will decrease the amount of time the diver may spend underwater which may be critical during a deep dive. Customers must be warned of this possibility if cylinders are delivered for use while warm. Always fill all breathing gas cylinders slowly to avoid overheating.

### 15.5 Pumping Air

To use the system to pump air, simply move the On/Off flow valve to the off position. No nitrox will be supplied to the HP compressor, and it will pump air only. Both the inline oxygen analyzer and fill oxygen analyzer should read 20.9% when the HP compressor is pumping air.

On/Off Flow Valve  
Handle in Off Position



## Notice

Always use oxygen analyzers to monitor oxygen content of any gas flowing through the system. Both air and nitrox are subject to variations in oxygen content.

### 15.6 Shutting Down

- 1) Shut off the nitrox membrane system by turning the regulator adjustment knob CCW to reduce input pressure to minimum setting and then closing the On/Off flow valve.
- 2) Manually drain all filter, compressor, and optional volume tank condensate drains.
- 3) Turn off LP compressor On/Off Switch. The compressor will go into shut down mode.
- 4) Turn off HP compressor when it has returned to pumping air, as determined by a fill oxygen analyzer reading close to 20.9% O<sub>2</sub>.

## 16.0 Nitrox Operation Notes

- Ensure all personnel who operate the system are properly trained in its use.
- Keep a log with details of each cylinder filled with nitrox, including the time and date, name of operator of system, name and certification number of diver, gas analysis, MOD, and cylinder pressure.

### 16.1 Correlation of Input Pressure to Oxygen Content

After the 10 hour break-in period for your nitrox system, you will notice that specific nitrox oxygen percentages always match specific input (feed) pressures once the system has warmed up. These pressures and percentages will be repeatable. If you find that the fill oxygen analyzer reads 36% O<sub>2</sub> when the input (feed) air pressure is at 125 psi (9 bar) record this pressure or make a mark on the input (feed) air pressure gauge indicating the O<sub>2</sub>%. Do this for each O<sub>2</sub>% that you normally make, making sure system has warmed up first. The next time nitrox with 36% O<sub>2</sub> is needed, adjust the regulator to 125 psi (9 bar) and wait for the oxygen analyzer reading to stabilize. You will find the analyzer reading to be very close to 36% O<sub>2</sub>, requiring only minor adjustments of the regulator to achieve the exact desired O<sub>2</sub>%.

### Notice

**Use the fill oxygen analyzer to verify the nitrox oxygen percentage prior to pumping. When using the feed air pressure reading to obtain specific oxygen percentage, minor adjustments of the feed air pressure regulator may be required to obtain the exact percentage desired.**

### 16.2 Hot Fills

While in the process of filling HP nitrox storage tanks, you may have a need to supply a walk-in customer with a SCUBA cylinder fill of a different nitrox mix. You can change mixes as follows:

- 1) With the nitrox system and HP compressor operating, isolate the HP nitrox storage tanks from the HP compressor by closing appropriate valves.
- 2) Record the membrane system input pressure reading
- 3) Slightly open fill whip valve on the HP compressor, and adjust so the running compressor maintains 1500-2000 psi (100-136 bar) outlet pressure.
- 4) Adjust the input (feed) air regulator to the pressure corresponding to the desired nitrox O<sub>2</sub>% for the SCUBA cylinder fill.
- 5) Allow the fill oxygen analyzer reading to stabilize, make any minor adjustments necessary to achieve the desired O<sub>2</sub>%, and then fill cylinder in normal manner.
- 6) When finished return regulator to previous setting, and allow the fill oxygen analyzer reading to stabilize. Make any minor adjustments necessary to achieve the desired O<sub>2</sub>%, and then resume filling storage tanks.

## 17.0 Maintenance

The following list of daily and routine maintenance items is intended as a guide. Refer to LP and HP compressor manuals for complete maintenance requirements.

### 17.1 Daily Maintenance

#### **Caution**

**Be sure to check compressor lubricant levels prior to each day of operation. Failure to ensure the proper lubricant level will lead to system damage.**

- 1) Check lubricant levels of both LP and HP compressors and add proper lubricants as required. See Section 14.1 and compressor manuals for details.
- 2) Check HP compressor filtration for condensate and proper operation of condensate drains. Refer to HP compressor manual for details.
- 3) Check LP filtration for condensate and proper operation of condensate drains.



#### **Warning**

**Use only the specified Nuvair lubricants in this system. The use of incompatible lubricants presents a risk of fire and/or explosion, and may result in system damage. This can lead to severe personal injury and death.**

#### **Warning**

**Be sure that all pressure has been relieved from the system prior to opening any filtration canister. Failure to vent pressure from the system prior to opening the canister can lead to serious personal injury or death.**

#### **Caution**

**If system is located in an area where there is high humidity and high heat, the life of all filtration elements may be as little as 35% of rated operating capacity. Check the compressor manual and appendix for details on filter element life factors.**

### 17.2 Routine Maintenance

- 1) LP compressor Lubricant: Change rotary screw compressor lubricant after the first 50 hour break in period. Change every 1000 hours thereafter along with the oil filter and air/oil separator. Only use lubricants rated for use with rotary screw compressors, such as Nuvair 546. Never mix compressor lubricants. See section 17.3 and LP compressor manual for details.
- 2) LP filtration Inspection: On a weekly basis, inspect each filter bowl for the presence of moisture and each element for any unusual degradation or wetness. No moisture should be in the final filter housing. (do not use system with moisture in the final filter housing) See Section 17.4 for details.

## ⚠ Caution

Special attention needs to be given to the arrangement of the four LP air filtration elements and bowls. Properly reinstall each element and bowl to the correct Housing. Improper sequence can cause damage to downstream components.

3) LP Filtration Elements: Change LP filters elements every 250 hours or yearly to maintain CGA Grade D air standards. Visually check differential pressure (DP) indicators on the HF7 and HF5 filters assist with monitoring replacement intervals. See Section 17.4 for details. If the nitrox system is operated in high humidity and/or high temperature, filter elements must be changed more often. See Appendix for details on Filter element life factors.

4) Semi-Permeable Membrane: No maintenance required. Service life exceeds 20 years if LP filtration is properly serviced to maintain Grade D air standards.

5) Membrane System Air Intake Filter: Inspect filter element every 3 months for visible particles. Change every 12 months or sooner if particles are visible.

6) Oxygen Analyzers: Replace oxygen sensor and battery as required. See manual included with nitrox system.



DP Indicator Changes from Green to Red as Filter Ages. Do Not Use When Red.

Air Intake Filter



## ⚠ Danger

Do not swallow (ingest) either the electrolyte from the oxygen sensor or the sensor itself. The Potassium Hydroxide chemical contained in the sensor can cause severe injury or death. If electrolyte or the Sensor is swallowed, seek medical attention immediately.



## ⚠ Danger

If after handling the oxygen analyzer or sensor, you find that your fingers or other parts of your body feel “slippery” or the skin or eyes sting, immediately flush affected area with clean, fresh water for at least 15 minutes. The stinging or slippery sensation is an indication of a leaking Sensor. The Potassium Hydroxide chemical contained in the sensor can cause severe injury or death. Seek immediate medical attention if eye contact is made or skin stinging persists.

\*The following items are not integral parts of this nitrox system, but proper maintenance is required to assure optimum performance.

- 1) HP Compressor Lubricant: Change HP compressor lubricant every 100 hours of operation in accordance with manufacturer’s guidelines. Only use lubricants rated for use with nitrox, such as Nuvair 455 or 751. Never mix compressor lubricants. Refer to HP compressor manual for details.
- 2) Breathing Air Filters: Change HP compressor filter elements in accordance with manufacturer’s guidelines to maintain CGA Grade E breathing air standards.

- 3) Air/Nitrox Quality Analysis: Take breathing air/nitrox samples quarterly for analysis to assure compliance with CGA Grade E breathing air standards.

## 17.3 Compressor Lubricant

The LP rotary screw compressor in your nitrox system uses Nuvair 546 food grade synthetic rotary screw compressor lubricant for rotary screw compressors. Customers may specify different lubricants, only use acceptable lubricants. This lubricant is thinner than the lubricants that are used in reciprocating HP compressors and must not be mixed with other compressor lubricants.

### Change LP Oil:

- After the first 50 hours of use
- Every 1000 hours or annually

### Change LP compressor oil filter:

- Every 1000 hours or annually

### Change oil separator element and pre-filter:

- Every 1000 hours or annually



## Warning

Use only the specified Nuvair lubricants in this system. The use of incompatible lubricants presents a risk of fire and/or explosion, and may result in system damage. This can lead to severe personal injury or death.

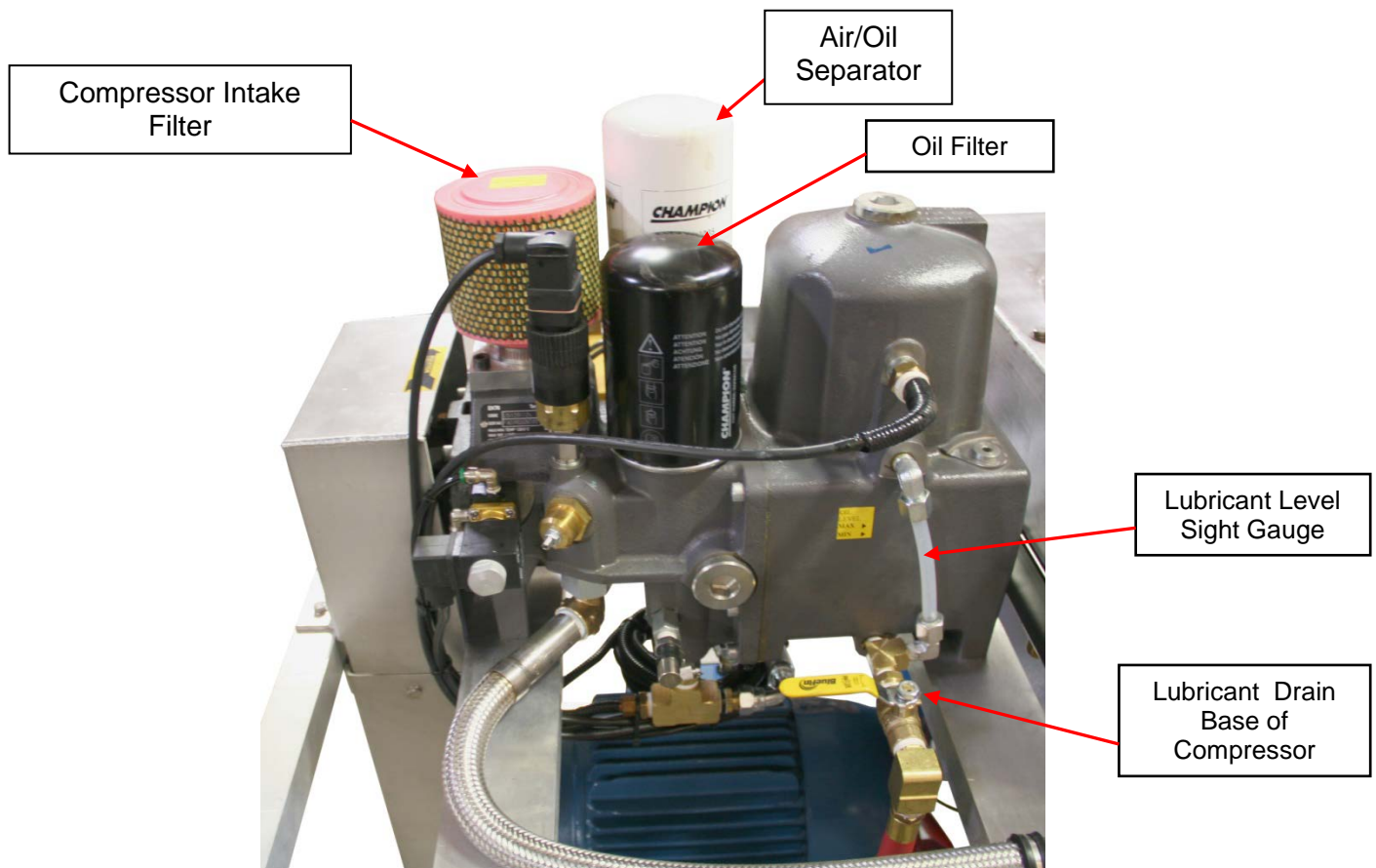

**Warning**

Never mix different lubricants together because equipment damage may occur when machinery is operated with improper lubricant.



**Warning**

Do not carry out any maintenance tasks if the compressor has just shut down. Wait for the compressor to cool to avoid skin burns.



**Warning**

Pressure must be properly drained from the system before opening the LP fill plug. Failure to drain pressure may result in severe personal injury.



**Warning**

Any oil spilled during the oil and oil filter change could cause personnel to slip and fall. Wear anti-slip footwear. Remove any traces of spilled oil immediately. Slips and falls may cause severe personal injury or death.

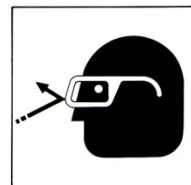

**Caution**

Wear eye protection, gloves, and skin protection when performing oil changes. Although the oil is not classified as a dangerous substance, the oil can be irritating to your eyes and skin.

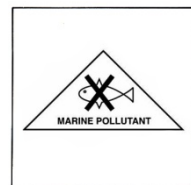
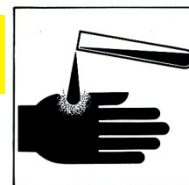

**Caution**

Both oil and oil filter are classified as “special wastes” and must be disposed of properly according to applicable national and local laws. Failure to dispose of these wastes properly can lead to death of wildlife as well as government fines and penalties.



**Warning**

All maintenance work must be carried out with the compressor off and the power supply lead unplugged from the main socket. Appropriate steps must be taken to tag out and lock out the electrical power. Failure to isolate this equipment from the power source while performing maintenance may result in severe personal injury or death.

17.4 LP Filtration

**Caution**

Special attention needs to be given to the arrangement of the four LP feed air filtration elements and bowls. Properly reinstall each element and bowl to the correct housing. Improper sequence can cause damage to downstream components

The use of Grade D or better supply air is critical to prevent the passing of any residual oil vapor into the membrane system. Three stages of Hankison LP filtration are used to produce Grade D air:

- 1) Particle Removal to 1 micron (Model No. HF7-20)
- 2) Coalescing & Water/Oil Vapor Removal to 0.01 micron (Model No. HF5-20)
- 3) Oil Vapor Removal to 0.003 PPM (Model No. HF1-20)

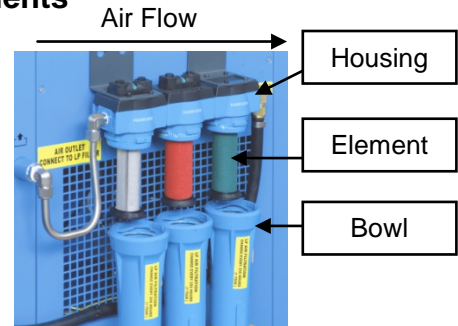

<u>HF7-20</u> Particle Removal	<u>HF5-20</u> Coalescing & Water/ Oil Vapor Removal	<u>HF1-20</u> Oil Vapor Removal
-----------------------------------	---	------------------------------------

**Filtration Inspection**

Open each Filter and inspect as follows:

1. Inspect bowl for the presence of moisture. A high level of moisture build-up in the HF7 or HF5 filter indicates improper operation of auto-drain floats. Any evidence of moisture in the HF1 Filter indicates the air is not cooling properly and moisture is not properly being removed. Excess moisture will prevent the final filter from operating properly.
2. Inspect Elements for any unusual degradation or wetness. Element degradation can indicate more serious problems. Contact Nuair for assistance.

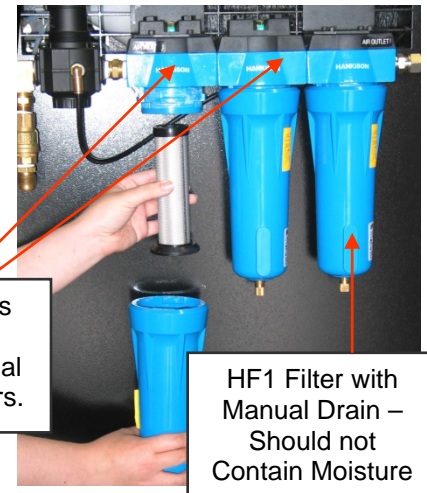

**Changing Filtration Elements**

Change Filter Elements every 250 hours if operated with the refrigerated air drier. If the nitrox generator is operated in high humidity and/or high temperature or without the drier, filter elements must be changed more often. See Appendix for details on Filter Element Life Factors. Visual differential pressure indicators on the HF7 and HF5 filters assist with monitoring replacement intervals.

- 1) Push up on the Bowl, rotate CCW, and lower to remove.
- 2) Gently rotate filter element and pull down off mounting post.
- 3) Replace element and reassemble in reverse order.

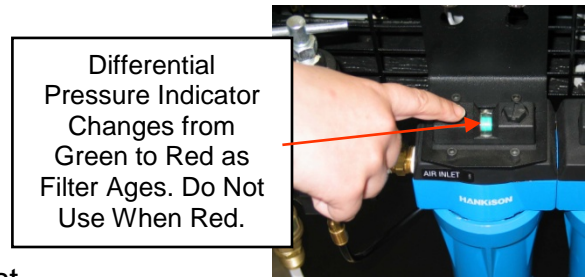

**Notice**

The interior of the filter bowls can be cleaned with a diluted solution of Simple Green™ and flushed thoroughly with clean water. This will assist to prolong the life of the element, bowl, and auto drain.



## LP600 Water Cooled Marine Nitrox Generator

### 17.5 Spare Parts List

See Rotary Screw Compressor manual for LP compressor parts list. Other nitrox generator components and related items are listed below.

Nitrox System Components	Type	Part Number
<b>Low Pressure Filtration</b>		
LP Filtration Element	Hankison HF 7-20	E7-20
	Hankison HF 5-20	E5-20
	Hankison HF 1-20	E1-20
<b>Rotary Screw Compressor Lubricant</b>		
Rotary Screw Compressor Lubricant, Food Grade	Nuvair 546, 1 Gal (Other Sizes Available)	9409
<b>Rotary Screw Compressor Maintenance Items</b>		
Rotary Screw Air Intake Filter 2"	EK76	A11207674
Rotary Screw Air Oil Separator	EK76	300KBA035
Rotary Screw Oil Filter	EK76	300KBA1446
<b>Nitrox Generator Components</b>		
Air Intake Filter Element	Mixing Tube	FT-14-100
<b>Analyzer Replacement Sensors</b>		
Pro O <sub>2</sub>	Replacement Sensor	9505
Pro O <sub>2</sub> Remote Panel Mount	Replacement Sensor	9506
<b>Related Equipment Components</b>		
Air/nitrox Quality Analysis Kit	Specify: (1) CGA Grade Required (2) Single Use or Program Use	
<b>Air/Nitrox (Reciprocating) Compressor Lubricant</b>		
Reciprocating Compressor, Food Grade	Nuvair 455, 1 Gal	9406
Reciprocating Compressor, Diester Based	Nuvair 751, 1 Gal	9403

**17.6 Service Record Log**

<b>Date</b>	<b>Technician Name</b>	<b>Service Performed</b>

**Appendix**

**Supply and Breathing Air Specifications**

All supply and breathing air must meet the following requirements of CGA G-7.1-1997. Supply air delivered to the nitrox membrane system must be purified to meet Grade D or E quality, , DIN 3188, EN 12021, CGA E and CSA and periodic air quality testing to assure compliance is recommended. All breathing air for diving produced by the downstream compressor must be purified to meet Grade E, DIN 3188, EN 12021, CGA E and CSA quality, and periodic air quality testing to assure compliance is mandatory.

<b>Item</b>	<b>Grade D</b>	<b>Grade E</b>
Oxygen	19.5-23.5%	20-22%
Carbon Dioxide (maximum)	1000 PPM	1000 PPM
Carbon Monoxide (maximum)	10 PPM	10 PPM
Hydrocarbons (maximum)	Not specified	25 PPM
Water Vapor (maximum)	Not specified	Not specified
Dew Point (maximum) (1)	Not specified	Not specified
Oil & Particles (maximum) (2)	5 mg/m <sup>3</sup>	5 mg/m <sup>3</sup>
Odor	None	None

- Notes: (1) Dew Point of supply air must be >10°F (6°C) colder than coldest ambient air expected  
 (2) Supply air delivered to the membrane system must contain <0.003 PPM oil vapor

All breathing nitrox produced for diving must be purified to meet these same requirements, except for oxygen content. nitrox oxygen content must measure within +/- 1% O<sub>2</sub> of the specified value of the mixture using a properly calibrated oxygen analyzer (i.e. nitrox produced with a target content of 32% O<sub>2</sub> must measure in the range of 31-33% O<sub>2</sub>). Periodic air quality testing to assure compliance is mandatory.

**Filter Element Life Factors**

Breathing air filter element life is typically rated by manufacturer based on an air temperature of 80°F at the filter inlet. Under normal operation this temperature is 12°F (5°C) warmer than the ambient air, resulting in an equivalent ambient temperature rating at 68°F (20°C).

To determine element life at a different ambient temperature, multiply the rated life by the life factor listed below:

<b>Filter Temperature</b>	<b>Ambient Temperature</b>	<b>Filter Element Life Factor</b>
53°F (12°C)	41°F (5°C)	2.6 x Life
62°F (17°C)	50°F (10°C)	1.8 x Life
71°F (23°C)	59°F (16°C)	1.35 x Life
<b>80°F (27°C)</b>	<b>68°F (20°C)</b>	<b>1 x Life</b>
89°F (32°C)	77°F (25°C)	0.8 x Life
96°F (36°C)	84°F (29°C)	0.55 x Life
105°F (41°C)	93°F (34°C)	0.45 x Life
114°F (46°C)	102°F (39°C)	0.35 x Life

## **OWNER'S WARRANTY RESPONSIBILITIES**

Failure of the owner to prevent equipment damage by complying with the procedures outlined below and in the operation manual will void the nitrox system warranty.

### **Installation:**

- All set up requirements and procedures provided in the nitrox system operation manual must be followed in their entirety including supply air cleanliness, compressor preparation, and installation of the nitrox system.
- Supply air to the membrane must be properly filtered to oil free CGA Grade D air quality or better to prevent damage to the membrane. Air quality testing of the supply air should be performed periodically and documented to assure compliance.
- If there is any doubt regarding the suitability of a HP or LP compressor for compressing nitrox, contact Nuvair or the compressor manufacturer before you connect your nitrox system.
- If an existing HP or LP compressor is to be used for compressing nitrox, all traces of the old lubricant must be removed and replaced with a nitrox compressor lubricant approved by Nuvair.
- Electrical wiring and connections should be made by a qualified electrician in accordance with all national and local electrical codes.
- Do not change the temperature setting on the heater thermostat control. Changes in temperature settings may cause membrane damage.
- To prevent compressor damage, only use the compressor Intake Hose provided. If a longer hose is required, contact Nuvair for assistance.
- Compressors must be provided adequate ventilation to operate properly and prevent heat damage. This requires an ambient temperature below 104 ° F (40 ° C), sufficient clearance from adjacent walls, and proper rotation direction.

### **Operation:**

- Do not use the nitrox system to supply a HP or LP compressor with nitrox mixtures containing more than 40% oxygen. Compressing higher concentrations of oxygen may cause severe compressor damage.
- Do not pump nitrox mixtures at pressures above the compressor manufacturer's rating, and never above 3600 psi (250 bar). Compressing nitrox at higher pressures may cause severe HP compressor damage.
- To prevent membrane damage, drain all low pressure filters and condensate tanks on a daily basis.
- If you become aware of an operational fault, stop using the equipment immediately and contact Nuvair for assistance.

### **Maintenance:**

- Change low pressure filter elements on a schedule determined by filter capacity and ambient temperature and humidity. Contact Nuvair if you need assistance establishing a schedule for your equipment and location.
- Replace membrane system air intake filter on a regular basis to prevent flow obstruction.
- Keep all nuts, bolts, fittings, connectors, and clamps tight.
- Keep a service record book showing that regular maintenance work has been carried out. If a warranty claim becomes necessary, it will aid in demonstrating that damage has not been caused by insufficient maintenance. Proof of maintenance may be required prior to determining the validity of a warranty request.

## **Nuvair Nitrox System Warranty**

Nuvair extends a limited warranty, which warrants the nitrox system to be free from defects in materials and workmanship under normal use and service for a limited period. The specific membrane component of the nitrox system is warranted according to the pro-rated terms as set forth below. All other Original Equipment Manufacturer (OEM) components used in the system are warranted only to the extent of the OEM's warranty to Nuvair. Nuvair makes no warranty with respect to these OEM components, and only warrants the workmanship that Nuvair has employed in the installation or use of any OEM component. This warranty is not transferable.

Nuvair will, at its discretion and according to the terms as set forth within, replace or repair any materials which fail under normal use and service and do not exhibit any signs of improper maintenance, misuse, accident, alteration, weather damage, tampering, or use for any other than the intended purpose. Determination of failure is the responsibility of Nuvair, which will work together with the customer to adequately address warranty issues. When any materials are repaired or replaced during the warranty period, they are warranted only for the remainder of the original warranty period. This warranty shall be void and Nuvair shall have no responsibility to repair or replace damaged materials resulting directly or indirectly from the use of repair or replacement parts not approved by Nuvair.

### **Pro-Rated Terms:**

Nuvair warrants the membrane component of the nitrox system to be free from defects in material and workmanship for a period of thirty-six (36) months from date of installation or forty-two (42) months from date of shipment by Nuvair, whichever may occur first. The warranty covers parts only and is prorated as follows:

- First Year Repair or replacement free of charge
- Second Year Warranty allowance of 70% of the current membrane component list price
- Third Year Warranty allowance of 40% of the current membrane component list price

A warranty registration card, supplied with system documentation, must be filled out and submitted to Nuvair for the warranty to be in full effect. If the warranty registration card is not received within thirty (30) days of installation, the thirty-six (36) month warranty will begin with the date of shipment from Nuvair. For warranty service to be considered, customer's account must be current or paid in full.

### **Maintenance Items:**

Any materials which are consumed, or otherwise rendered not warrantable due to processes applied to them, are considered expendable and are not covered under the terms of this policy. This includes maintenance and consumable items listed as part of a suggested maintenance program included with system documentation.

### **Return Policy:**

Application for warranty service can be made by contacting Nuvair during regular business hours and requesting a Return Material Authorization (RMA) number. Materials that are found to be defective must be shipped, freight pre-paid, to the Nuvair office in Oxnard, California. Upon inspection and determination of failure, Nuvair shall exercise its options under the terms of this policy. Warranty serviced materials will be returned to the customer via Nuvair's preferred shipping method, at Nuvair's expense. Any expedited return shipping arrangements to be made at customer's expense must be specified in advance.

### **Limitation of Warranty and Liability:**

Repair, replacement or refund in the manner and within the time provided shall constitute Nuvair's sole liability and the Purchaser's exclusive remedy resulting from any nonconformity or defect. Nuvair shall not in any event be liable for any damages, whether based on contract, warranty, negligence, strict liability or otherwise, including without limitation any consequential, incidental or special damages, arising with respect to the equipment or its failure to operate, even if Nuvair has been advised of the possibility thereof. Nuvair makes no other warranty or representation of any kind, except that of title, and all other warranties, express or implied, including warranties of merchantability and fitness for a particular purpose, are hereby expressly disclaimed. No salesman or other representative of Nuvair has authority to make any warranties.

**Additional Record of Changes**

It is the responsibility of the owner of this product to register their ownership with Nuvair by sending the warranty card provided to Nuvair. This card is to establish registration for any necessary warranty work and as a means of communication that allows Nuvair to contact the user regarding this product.

The user must notify Nuvair of any change of address by the user or sale of the product. All changes or revisions to this manual must be recorded in this document to ensure that the manual is up to date.

<b>Change Date</b>	<b>Description of Change</b>
<b>8/2018</b>	<b>New Revision with EK76 update pictures and info</b>





Nuvair  
Phone +1 805 815 4044  
Fax 1 486 0900  
1600 Beacon Place  
Oxnard, CA 93033, USA  
info@nuvair.com  
[www.nuvair.com](http://www.nuvair.com)

Revision 08.18