



Operation Manual

Fill Containment Station



SKU NSS-2P-OCA (as shown)

If you have any questions about this equipment, please contact Technical Support at:

Nuvair
1600 Beacon Place
Oxnard, CA 93033 USA

Phone: +1.805.815.4044
Fax: +1.805.486.0900
Email: info@Nuvair.com

Hours: Monday through Friday
8:00 AM to 5:00 PM Pacific Time



WARNING

This Operation Manual contains important safety information and should always be available to those personnel operating this equipment. Read, understand, and retain all instructions before operating this equipment to prevent injury or equipment damage.

Every effort was made to ensure the accuracy of the information contained within. Nuvair, however, retains the right to modify its contents without notice.

Under Nuvair's system of continuous improvement, certain components may be updated or changed as higher quality or more efficient parts and assemblies become available.

Nuvair will make every effort to update manuals as parts and functional aspects change. However, the look or location of components on your product may differ from those in this manual if improvements have been made that do not affect functionality or operational procedures.

Units pictured may also be equipped with different options than those on your product. In this case, the basic operational and maintenance guidelines will still apply.

If you have problems or questions after reading the manual, stop and call Nuvair at +1.805.815.4044 for information.

Table of Contents





1.0	Introduction	4
1.1	Symbol Conventions.....	4
1.2	System Description	4
1.3	Required Operator Training	4
1.4	Important Information for the User	5
1.5	Foreword	5
1.6	Assistance	6
1.7	Responsibility	6
2.0	Safety Warnings	7
2.1	Safety and Operation Precautions	8
3.0	Fill Containment Station Layout	9
4.0	General Safety Rules	11
4.1	Protective Clothing	11
4.2	Checks and Maintenance	11
5.0	Safety Information Labels: Location & Description	11
6.0	System Components	11
7.0	Fill Containment Station Specifications	12
7.1	Unpacking and Installation.....	12
8.0	Checks for the Start of Each Working Day	12
8.1	Check Refill Hoses	12
8.2	Storing Technical Documentation	12
9.0	Fill Containment Station Operation	13
10.0	Maintenance	19
10.1	Foreword	19
10.2	General	19
10.3	Unscheduled Work	19
10.4	Scheduled Maintenance Table	20
10.5	Changing Air Filtration Cartridges.....	20
10.6	Temperature Effect on Filter Life	21
10.7	Changing Flex Hoses	22
10.8	Dismantling and Putting the Fill Containment Station Out of Service	22
11.0	Maintenance Register	23
11.1	Customer Service	23
11.2	Scheduled Maintenance	23
11.3	Nuvair Customer Care Contact.....	23
12.0	Spare Parts List	23
13.0	Service Log	24
14.0	Appendix	25
14.1	Supply and Breathing Air Specifications	25
14.2	Filter Element Life Factors.....	25
15.0	Nuvair Fill Containment Station System Warranty	26

1.0 Introduction

This manual will assist you in the proper set-up, operation, and maintenance of the Nuair NSS Series of fill containment stations. Be sure to read the entire manual.

1.1 Symbol Conventions

This manual uses certain words and symbols to call your attention to conditions, practices or techniques that may directly affect your safety. Pay particular attention to information introduced by the following symbols or words:

SYMBOL	MEANING	DESCRIPTION
	DANGER	Indicates an imminently hazardous situation, which if not avoided, will result in serious personal injury or death.
	CAUTION	Indicates a potentially hazardous situation, which if not avoided, could result in serious personal injury or death.
	WARNING	Indicates a potentially hazardous situation, which if not avoided, may result in minor or moderate injury. It may also be used to alert against unsafe practices.
	NOTICE	Notifies people of installation, operation or maintenance information which is important but not hazard-related.

1.2 System Description

The Nuair NSS Fill Containment Station Series is designed for use while filling high-pressure gas cylinders (DIN, yoke, or SCBA). The all-steel construction of the fill containment station (also referred to as a “blast cabinet” or “fragmentation cabinet”) offers protection for operators during the cylinder filling process. Its heads-up control panel allows monitoring and adjustments from a standing position. The cabinet is third-party tested to meet or exceed NFPA 1901 standard. Vertical blast tubes direct air blast and debris away from the operator should a failure occur. The NSS Series can handle, 2, 3, or 4 cylinders.

The model pictured is the NSS-2P-OCA. It is a 2-cylinder fill containment station with pneumatic doors and oxygen compatible air filtration.



Figure 1. Model NSS-2P-OCA.

1.3 Required Operator Training

This manual must be read carefully and in its entirety.

- All fill station operators and maintenance personnel must read this entire manual with due care and attention and observe the instructions/information contained herein.
- Company owners ensure that the operator has the required training for operation of the fill station and that he/she has read the manual.

1.4 Important Information for the User

The information/instructions for fill station use contained in this manual concern the **Nuvair NSS Series** of fill containment stations.

- The instruction manual must be read and used as follows:
- Read this manual carefully; treat it as an essential part of the fill containment station.
- The instruction manual must be kept where it can readily be consulted by fill containment station operators and maintenance staff.
- Keep the manual for the working life of the fill containment station.
- Make sure updates are incorporated in the manual.
- Make sure the manual is given to other users or subsequent owners in the event of resale.
- Keep the manual in good condition and ensure its contents remain undamaged.
- Do not remove, tear, or rewrite any part of the manual for any reason.
- Keep the manual protected from damp and heat.
- If the manual is lost or partially damaged and its contents cannot be read it is advisable to request a copy from Nuvair.

1.5 Foreword

The regulations/instructions for use contained in this manual constitute an essential component of the supplied fill containment station.

These regulations/instructions are intended for an operator who has already been trained to use this type of fill containment station. The contained information is necessary and essential for the efficient and proper use of the fill containment station.

Hurried or careless preparation leads to improvisation, which is the cause of accidents.

Before beginning work, read the following suggestions carefully:

- 1) Before using the fill containment station, gain familiarity with the tasks to be completed and the allowable working position.
- 2) The operator should always have the instruction manual available.
- 3) Plan all work with due care and attention.
- 4) Operators must have a detailed understanding of where and how the fill containment station is to be used.
- 5) Before starting work make sure that safety devices are working properly and that their use is understood; in the event of any doubts do not use the fill containment station.
- 6) Observe the warnings given in this manual with due care and attention.
- 7) Constant and careful preventive maintenance will always ensure a high level of safety when using the fill containment station. Never postpone repairs and have them carried out by specialized personnel only; use only original spare parts.

1.6 Assistance

Nuvair technicians are at your disposal for all routine/unscheduled maintenance work. Please forward your request for assistance to Nuvair by phone, fax or e-mail:

Phone: +1.805.815.4044
 Fax: +1.805.486.0900
 Email: info@Nuvair.com

1.7 Responsibility

Nuvair considers itself exonerated from any responsibility or obligation regarding injury or damage caused by:

- Failure to observe the instructions contained in this manual that concern the running, use and maintenance of the fill containment station.
- Inappropriate incorrect actions during use or maintenance of the fill containment station.
- Modifications made to the fill containment station without prior written authorization from Nuvair.



WARNING

Maintenance and repairs must only be carried out using original spare parts and qualified technicians. Nuvair cannot be held liable for any damages caused by failure to observe this rule. The fill containment station is guaranteed as per the contractual agreements made at the time of sale. Failure to observe the regulations and instructions for use contained in this manual shall render the warranty null and void.



DANGER

- Use only tested, certified storage tanks: do not exceed the indicated working pressure.
- Use the fill containment station in areas free from dust, risk of explosion, corrosion, and fire.
- Improper use could have serious consequences for the user.
- Do not disconnect the hose from the fittings or the clamp when under pressure.
- Change the air purification filters regularly as described in section 10.0.
- Never pull a plug out by tugging the cord. Make sure the cord is not bent at a sharp angle and that it does not rub against any sharp edges. Use of extensions is not advised.
- Never operate the fill containment station when the power cord is damaged, or the power supply covers/guards are removed.
- All routine and unscheduled maintenance tasks must be carried out with the fill containment station depressurized.
- The high-pressure flex hose that connects to external components must be in good condition, especially in the areas near the fittings.
 - The plastic sheath that covers the hose must not show any signs of abrasion otherwise damp could get in, corrode the steel braid and weaken it.
 - The hose must be changed periodically (yearly) or when it shows signs of wear.
 - Failure to observe this rule could seriously endanger the users' safety.
 - Make sure the minimum bending radius of the hose is no less than 250 mm (9.8 inches).

To ensure maximum working efficiency, Nuvair has constructed the fill containment station with carefully selected components and materials. The fill containment station is tested prior to delivery. Continued fill

containment station efficiency over time will also depend on proper use and maintenance as per the instructions contained in this manual.

All the components, connections and controls used in its construction have been designed and built to a high degree of safety to resist abnormal strain or in any case a strain greater than that indicated in the manual. Materials are of the finest quality; their introduction and storage in the company and their utilization in the workshop are controlled constantly to prevent any damage, deterioration, or malfunction.



DANGER

Before carrying out any work on the fill containment station each operator must have a perfect understanding of how the fill containment station works, know how to use the controls, and have read the technical information contained in this manual.

- It is forbidden to use the fill containment station under conditions or for purposes other than those indicated in this manual and Nuair cannot be held liable for breakdowns, problems or accidents caused by failure to observe this rule.
- Check that the fittings provide a proper seal by wetting them with soapy water: Stop using the fill containment station and eliminate any leaks immediately when detected.
- Do not attempt to repair high pressure tubes by welding them or while the fill containment station is pressurized.
- Do not empty storage tanks completely—not even for long term storage—as this practice allows damp air to get in and eventually corrode the tank.
- It is forbidden to tamper with, alter or modify, even partially, the systems and equipment described in this instruction manual, especially as safety guards and safety symbols are concerned.
- It is also forbidden to carry out work in any way other than that described or to neglect the illustrated safety tasks.
- The safety information and the general information given in this manual are very important.

2.0 Safety Warnings

Nuair has taken extreme care in providing you with the information you will need to operate this system. However, it is up to you to carefully read this manual and make the appropriate decisions about system safety.



WARNING

This equipment is used to provide breathing air or nitrox for the purpose of life support. Read this manual in its entirety. Failure to heed the warnings and cautions contained in this document may result in severe injury or death.



WARNING

The equipment you will be using to fill air or nitrox cylinders will expose you to high-pressure gas. Gas, even under moderate pressures, can cause extreme bodily harm. Never allow any gas stream to be directed at any part of your body.



WARNING

Any pressurized hose can cause extreme harm if it comes loose or separates from its connections while under pressure and strikes any part of your body. Use appropriate care in making and handling all gas connections.

**WARNING**

Do not use any form of mineral oil or synthetic lubricant not rated for the fill containment station use. Use only the recommended fill containment station lubricant as necessary.

2.1 Safety and Operation Precautions

Because a fill containment station is a piece of machinery with moving parts and high-pressure gas, the same precautions should be observed as with any piece of machinery of this type where carelessness in operations or maintenance is hazardous to personnel. In addition to the many obvious safety precautions, those listed below must also be observed:

1. Read all instructions completely before operating any fill containment station.
2. For installation, follow all local safety codes and the Occupational Safety and Health Administration (OSHA) standards.
3. Protect all power cables from contacting sharp objects. Do not kink power cables and never allow the cables to contact oil, grease, hot surfaces, or chemicals.
4. Make certain that power source conforms to the requirements of your equipment.
5. Do not attempt to remove any parts without first relieving the entire system of pressure.
6. Do not operate the system at pressures more than its rating.
7. Periodically check all safety devices for proper operation. Do not change pressure setting or restrict operation in any way.
8. Be sure no tools, rags or loose parts are left on the fill containment station.
9. Do not use flammable solvents for cleaning.
10. Exercise cleanliness during maintenance and when making repairs. Keep dirt away from parts by covering parts and exposed openings with clean cloth or paper.
11. Do not operate the fill containment station without guards, shields, and doors secured in place.
12. Do not operate associated gas compressors in areas where there is a possibility of carbon monoxide, carbon dioxide, nitrogen, or flammable or toxic fumes.
13. Inspect unit daily to observe and correct any unsafe operating conditions found.
14. Compressed air can be a serious hazard. Always use caution. Never direct air stream at any part of the body as this can cause injuries.
15. Compressed air from this machine must not be used for food processing or breathing air without adequate downstream filters, purifiers and controls and periodic air quality testing.
16. Always use an air pressure-regulating device at the point of use, and do not use air pressure greater than marked maximum pressure.
17. Check hoses for weak or worn conditions before each use and make certain that all connections are secure.

The user of any fill containment station manufactured by Nuvair is hereby warned that failure to follow the preceding Safety and Operation Precautions can result in injuries or equipment damage. However, Nuvair does not state as fact nor does it imply that the preceding list of Safety and Operation Precautions is all-inclusive, and further that the observance of this list will prevent all injuries or equipment damage.

3.0 Fill Containment Station Layout

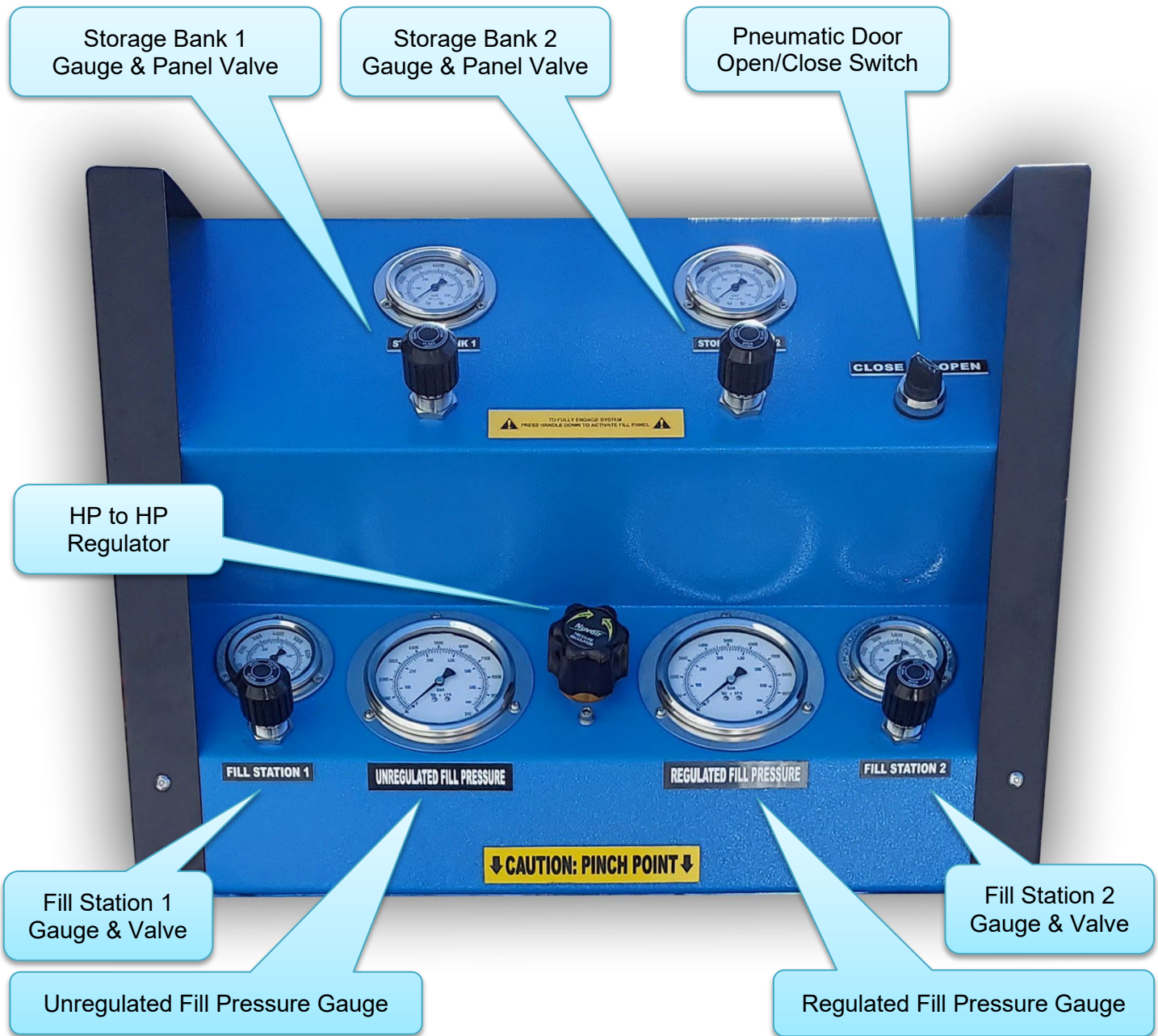



Compressor
Input Valve*

OCA
Filtration

Vent



*** WARNING**

Turn off compressor input valve if transferring gas mixtures of more than 21% oxygen content between Storage Bank 1 and Storage Bank 2.

4.0 General Safety Rules

The fill containment station must only be used by qualified personnel. They must fully understand the arrangement and function of all the controls, instruments, indicators, and any information labels.

4.1 Protective Clothing

All operators should use injury prevention items such as gloves, hard hat, eye goggles, accident prevention shoes and ear protection as deemed necessary (Figure 2).



Figure 2. Protective clothing examples.

4.2 Checks and Maintenance

When work is being performed on the fill containment station, apply “DO NOT USE” signs on the operational side of the fill containment station to prevent accidental use of the station while undergoing repair/maintenance (Figure 3).

Inspect the fill containment station carefully every day it is used as per the checklist given in this manual.

5.0 Safety Information Labels: Location & Description

Safety information labels are affixed to various parts of the fill containment station. Understand the meaning of each label and follow any instructions given on any label.

1. Caution: Pinch Point. This safety label indicates the pneumatic door latch side where body parts can become pinched and injured.
2. Air filtration cartridge change information label. To change the filter cartridges, see section 10.5.



Figure 3. “Do Not Use” sign.

6.0 System Components

- NSS Series High-Pressure Fill Containment Station
 - 2-Cylinder Capacity (Maximum Cylinder Size: 80 cu ft Scuba Tank with Boot)
 - Pneumatic Door Controller
 - Oxygen Compatible Air (OCA) Filtration
- (2) SCBA Fill Whips and Valves
- (2) OCA Filtration Towers
 - 40,000 cu ft OCA (Oxygen Compatible Air) Supply

7.0 Fill Containment Station Specifications

Fill Containment Station Series	NSS
Air Quality	CGA Grade E
Maximum Operating Pressure	4500 psi (310 bar)
Structural Hardware	Grade 8 Steel
Protection Between Operator and Cylinders	0.5 in (12.7mm) Steel
Number of Cylinders	2
Dimensions (H x W x D)	59 x 26 x 25 in (150 x 66 x 64 cm)
Weight	560 lb (254 kg)



CAUTION

Ambient room temperature should never exceed +113°F (45°C) during operation of the fill containment station system. Operation at higher temperatures may lead to system damage and malfunction.

7.1 Unpacking and Installation

- Please read all information supplied before physically installing the fill containment station system.
- Unpack the system and remove from the pallet. Visually inspect the system to make sure there has been no damage during shipping. If damaged, please call Nuvair to file a damage report. Please take photos and supply detailed information about the damage.

8.0 Checks for the Start of Each Working Day

Inspect the exterior of the fill containment station (couplings, pipes, pneumatic components, etc.) and check for any leaks. Replace parts where necessary or contact **Nuvair**.

8.1 Check Refill Hoses

Inspect the refill hoses and make sure there are no cuts, holes, abrasions, leaks etc. If necessary, replace with new hoses.

8.2 Storing Technical Documentation

The operation manual and any appendices must be stored carefully and must always be kept where they can be accessed easily for immediate review.



WARNING

This Operation Manual contains important safety information and should always be available to those personnel operating this equipment. Read, understand, and retain all instructions before operating this equipment to prevent injury or equipment damage. The Operation Manual is an integral part of the fill containment station and must always be handed over in the event of a change in ownership.

9.0 Fill Containment Station Operation



NOTICE
During refill, the operator must be in the work area.



WARNING
During tank refill, those not involved in the refill procedure must maintain a safety distance of at least 9 feet (3 meters). Also, it is forbidden to disconnect the hoses from the fittings while the station is under pressure. If an emergency occurs during refill, shut down the fill containment station immediately.



DANGER
Should tanks show evident signs of internal or external corrosion, do not refill them even if they have been tested.



WARNING
Use only tested tanks (as proven by a test stamp and/or certificate). The working and tank refill pressures are stamped on the tank shoulder. It is forbidden to refill them at a pressure greater than that indicated.

Different fill valves are available at the time of purchase. Variations include INT (Yoke), DIN232, DIN300, and SCBA. To refill cylinders, follow procedures described below and as illustrated in Figure 4:

- Check that cylinders to be refilled are in good condition.
 - Cylinders must be inspected as required by local law and have evidence (stamped or label) attesting to said certification or inspection.
 - Conduct a visual inspection of the cylinder/s exterior.
- Check that fill whips and associated fittings are in good condition.
- Set the desired fill pressure using the dial-a-pressure switch.
- Fit the hose connector (a) to the fill valve (b).
- Screw in the fill valve knob (c) until it is tightened.
- Check that the bleed valve (f) is closed by rotating it clockwise.
- Open the valve (d) by rotating it counterclockwise.
- Start the fill containment station.
- Open the valve (e) by rotating it counterclockwise.
- Once refilling has been completed wait for automatic shutdown of the fill containment station with the pressure switch.
- Close valves (d) and (e) by rotating them clockwise.
- Open the bleed valve (f) by rotating it anticlockwise until all the residual air in the whip has been expelled.
- Unscrew the fill valve knob (c) by rotating it counterclockwise.

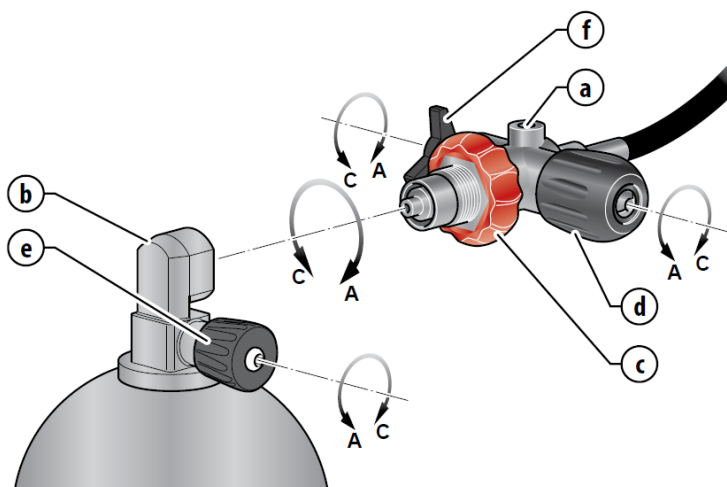
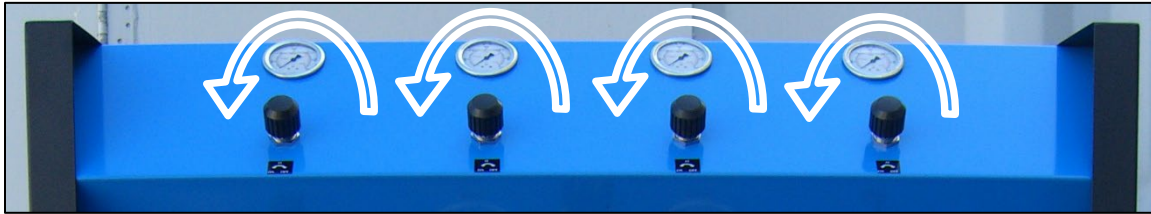

Figure 4. Tank refill illustration (DIN valve pictured).

- Disconnect the tank fill valve.

Never drain a tank completely, not even for seasonal storage or long periods of inactivity. Pressure prevents internal damage caused by moisture intrusion.



Step 1: Turn all panel valves to the off position by rotating clockwise to close.



Step 2: Turn HP to HP regulator counterclockwise (decrease).



Step 3: Open front door by turning door switch. Door opens automatically.



Step 4: Check cylinder for proper rating valid test date, and maximum fill pressure.



Step 5: Place cylinder into fill containment station compartment.



Step 6: Connect fill whip to cylinder.

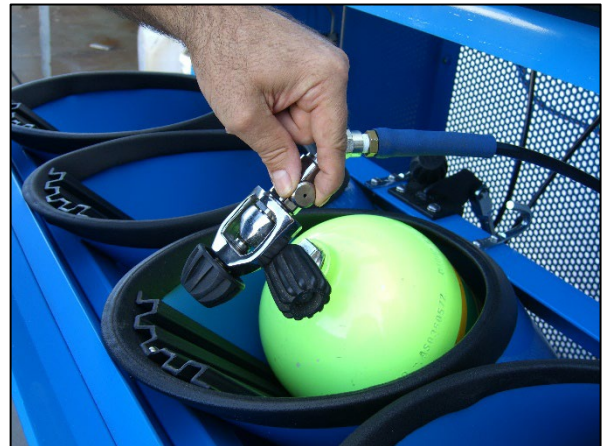

Step 7: Close fill whip bleed drain.



Step 8: Open cylinder valve.

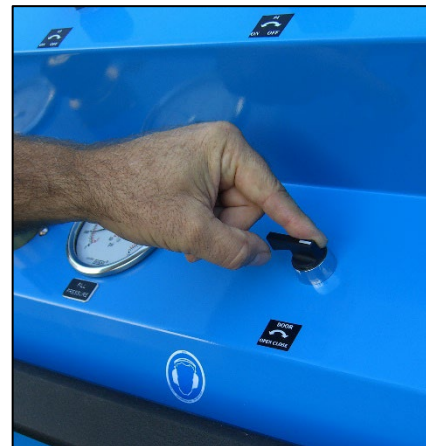

Step 9: Close door.



Step 10: Open fill station valve.

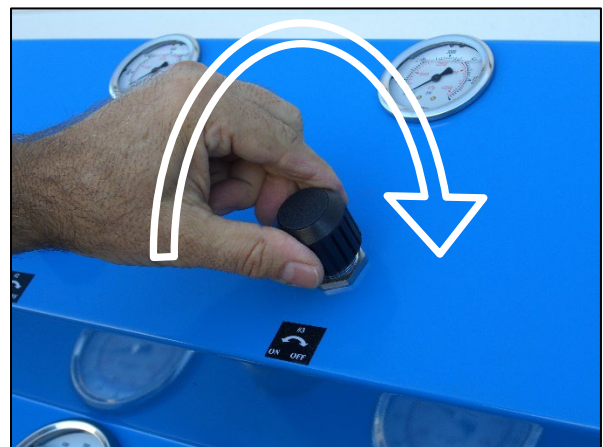

Step 11: Open tank fill valve slowly.

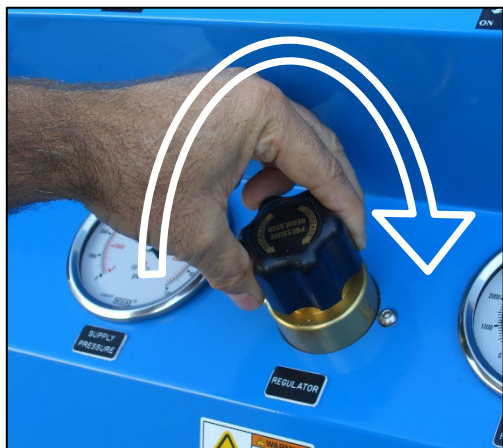

Step 12: Slowly increase regulator pressure to desired fill pressure.

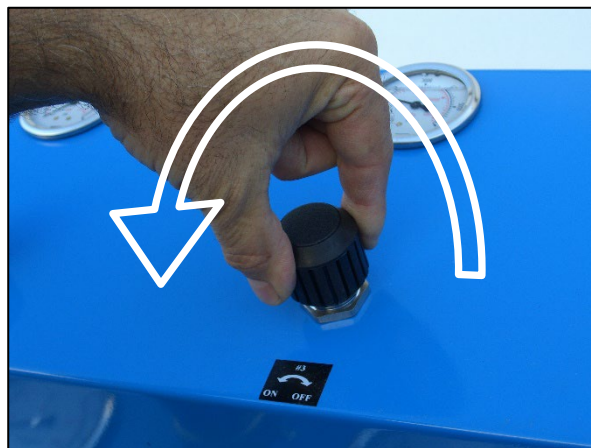

Step 13: When cylinder is full, close tank fill valve.



Step 14: Open fill station door.

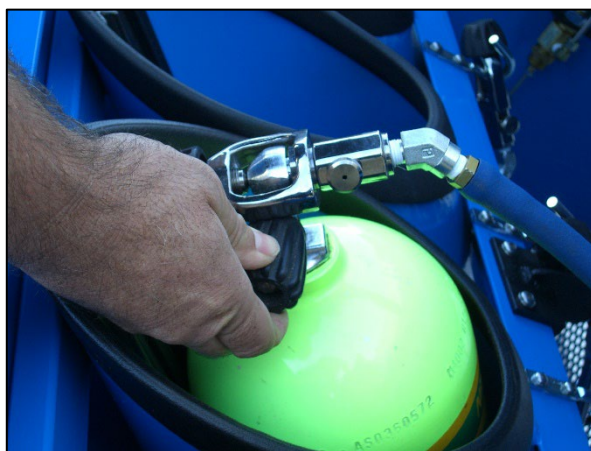

Step 15: Close cylinder valve.



Step 16: Open fill whip bleed valve to relieve pressure.



Step 17: Remove fill whip from cylinder.



Step 18: Remove cylinder from compartment.

Step 19: Repeat steps 4 to 18 to fill additional cylinders or go to Step 20.



Step 20: Close fill station door.

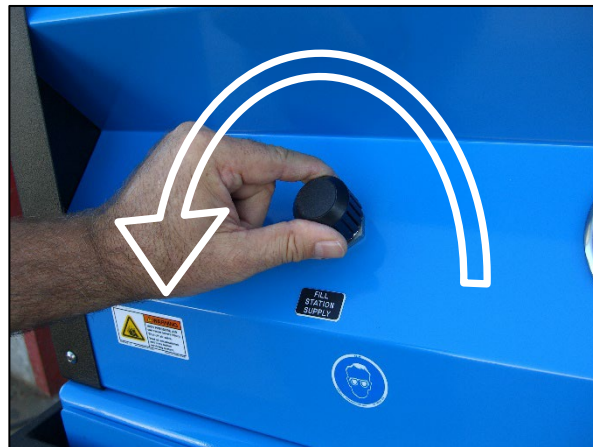

Step 21: Turn fill supply off.

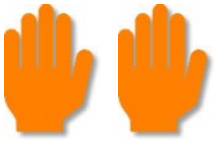

WARNING

Bleed pressure from fill whips before removing fill whip fittings from cylinder.

WARNING

Keep SCBA fill whip fitting clean by capping open end of fill whip fitting.
(See image below for additional information.)

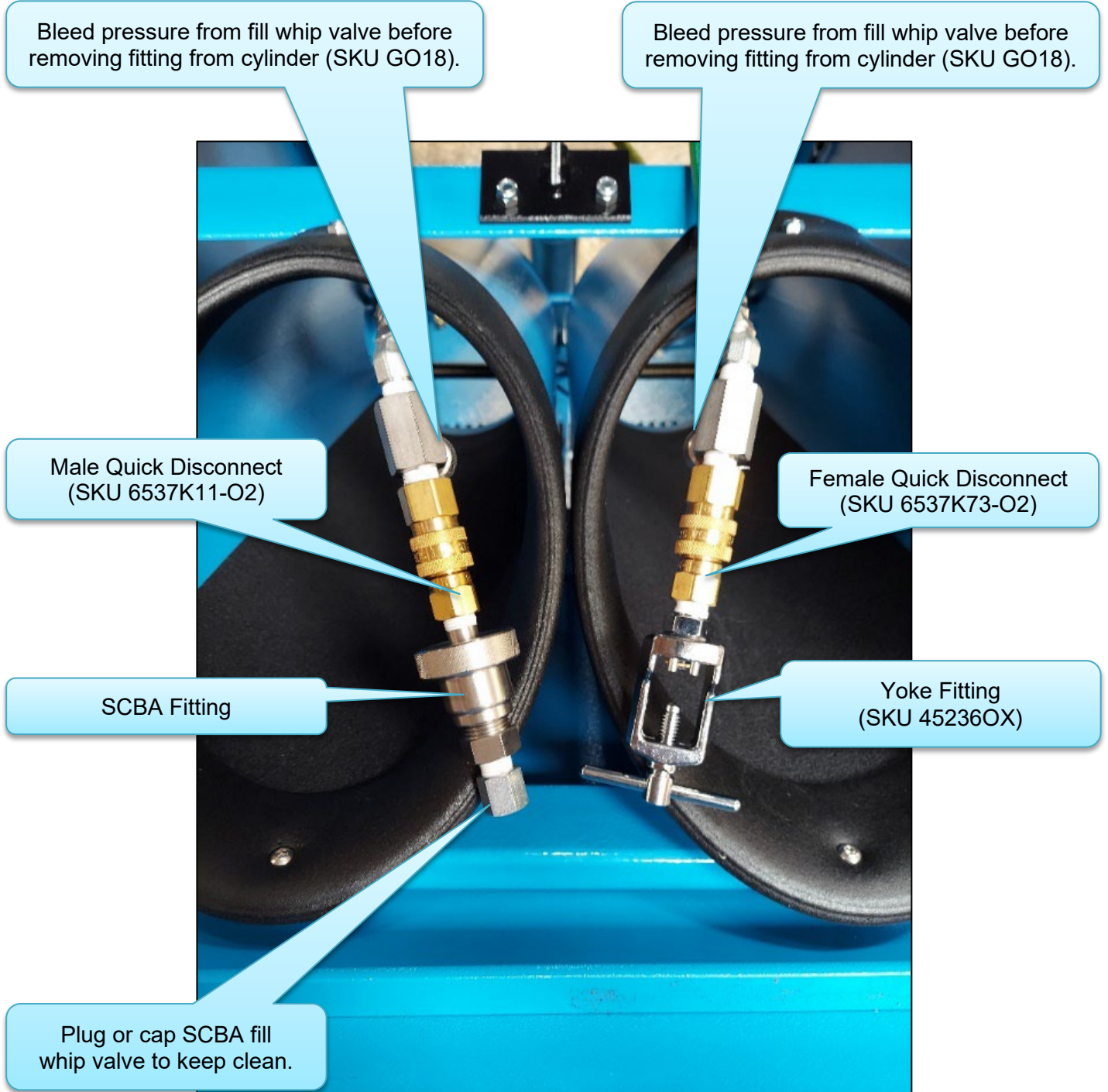

10.0 Maintenance

10.1 Foreword

To obtain the best possible performance from the fill containment station and ensure a long working life for all its parts it is essential that personnel follow the use and maintenance instructions with extreme diligence. It is advisable to read the information below and consult the manual every time a problem arises. For further information, please contact Nuvair:

Phone: +1.805.815.4044
Email: info@Nuvair.com



DANGER

Depressurize the entire fill containment station circuit before carrying out any maintenance tasks. To depressurize the fill containment station, open the drain valve.

10.2 General

- Proper maintenance of the fill containment station requires thorough cleaning.
- This type of refill station, designed and built according to the most advanced technological criteria, requires only minimum preventive and routine maintenance.
- The residual pressure present in the fill containment station and all lines must be released.
- During disassembly and reassembly of the fill containment station, always use suitable wrenches/tools so as not to damage the relevant components.
- Loosen stiff parts with a copper or plastic mallet.
- When refitting parts make sure they are clean and lubricated sufficiently.
- Fill containment station maintenance tasks must only be carried out by authorized personnel and recorded in the Service Log of this manual.

10.3 Unscheduled Work

Unscheduled work involves repairs and/or replacement of the mechanical parts of one or more fill containment station components. This work normally needs to be done after some years of use. If substantial modifications are made, the manufacturer cannot be held liable for any dangers that might arise. This work must be carried out by a Nuvair approved mechanic.

10.4 Scheduled Maintenance Table

Maintenance interval times are for typical use and may vary based on the conditions under which the fill containment station is used.

Before Every Use	Hours											
	5	25	50	100	250	500	1000	2000	3000	4000	5000	20,000
Hourly Maintenance												
Hyperfilter Complete					○							
HP Flex Hoses			○						●			
Fitting/Hose Leak Check					○							
Safety Valve					○						●	

○ Checking and cleaning ● Change

Annual Maintenance	Years			
	1	5	10	15
Hyperfilter Complete				●
HP Flex Hoses		●		
Safety Valve			●	

○ Checking and cleaning ● Change

10.5 Changing Air Filtration Cartridges

Correct filtering system component maintenance ensures that the quality of the air exiting the fill containment station complies with the international breathing air standards.

The air filtration elements (cartridges) must be replaced at intervals calculated on the characteristics of the environment in which the fill containment station is located. To calculate these intervals, refer to the table in section 10.6.

The filter cartridge must be replaced before the air develops an unpleasant smell, when the litmus test paper mounted inside the cartridge element turns white or a color other than blue.

The fill containment station comes standard with one (1) drying filter (SKU X96677) and one (1) breathing air filter (SKU X96337). Do **NOT** use any substitute. Change filter elements every 40,000 cubic feet of air pumped. If the fill containment station system is operated in high humidity and/or high temperature, filter elements must be changed more often. See section 10.6 for details on filter element “life factors.”



CAUTION

A special breathing air filter element (containing a desiccant blend, activated carbon, and a carbon monoxide catalyst) must be used when a diesel- or gasoline-powered compressor is within proximity of the fill containment station.

- Shut down the fill containment station system.
- Open and leave open the bleed valve/s to vent all pressure from the circuit.
- Use the wrench (a, Figure 6) to apply leverage on the screw heads (b) of the plug (c) and rotate counterclockwise. If a filter wrench (SKU TL-033) is not available, a large screwdriver can be used to unscrew the filter plug (1, Figure 5).
- Remove the filter plug (2, Figure 5).

- Remove the first cartridge (3, Figure 5) and the second cartridge; replace both with new cartridge elements. Place pressure on each cartridge (4, Figure 5) to seat the element fully into the canister. Replace the O-ring (e, Figure 6) on the plug (c) every time the filter is changed.
- Reinstall cap to canister by rotating clockwise and tightening with screwdriver or cap wrench.
- There are sealing O-rings (e-f, Figure 6) on the plug and the filter cartridge. If these O-rings deteriorate, the air is released via the venting hole (g).
- If you notice any venting from this hole replace the O-rings. When replacing the O-rings observe the precautions described at the start of the section.
- Close the bleed valve/s.



DANGER

Do not carry out these tasks if the fill containment station has just shut down and is hot; wait for the fill containment station to cool. All maintenance work must be carried out with the fill containment station OFF and the power supply lead unplugged from the wall socket.



WARNING

Be sure that all pressure has been relieved from the system prior to opening any filtration canister. Failure to vent pressure from the system prior to opening the canister can lead to serious personal injury or death. Difficulty turning the filter cap may indicate there still is pressure in the filter canister.



CAUTION

If the fill containment station is in an area where there is high humidity and high heat, the life of all filtration elements may be as little as 35% of rated operating capacity. Check the fill containment station manual and appendix for details on Filter Element Life Factors.

10.6 Temperature Effect on Filter Life

This Filter Replacement Frequency Calculation Table is based on total hours of fill containment station runtime. The table values are based on pressure maintenance valve calibrated to 2900 psi (200 bar). Higher pressures will affect overall performance. Filter Replacement “Life Factors” are discussed in section 14.2.

Filter Temperature		Filter Duration (in hours)
°F	°C	Total Fill containment stations Hours
104	40	63
86	30	106
68	20	185
50	10	337



Figure 6. Changing air filter cartridge.

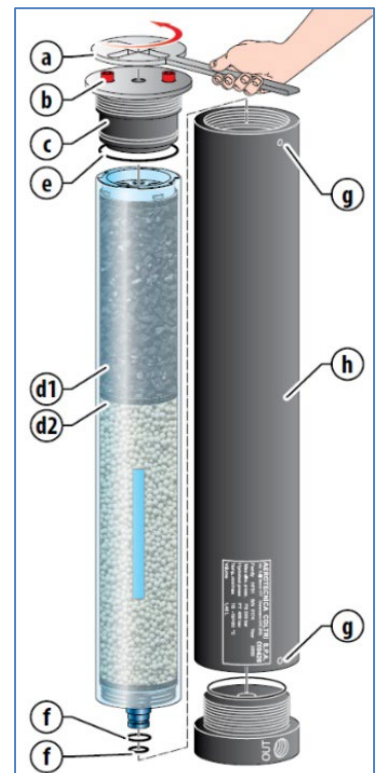

Figure 6. Filter cartridge and cartridge parts.



WARNING

The active carbon filters are classified as special waste once the fill containment station has been used to make air. They must be disposed of in compliance with the local antipollution standards in force.

10.7 Changing Flex Hoses

The hoses must be changed periodically (every 5 years or every 3000 hours) or when they show signs of abrasion/wear/damage. The bending radius of the hoses must not be less than 250 mm (9.8 in).



DANGER

Do not carry out these tasks if the fill containment station has just shut down and is hot; wait for the fill containment station to cool. All maintenance work must be carried out with the fill containment station OFF and the power supply lead unplugged from the wall socket.



DANGER

Depressurize the entire fill containment station circuit before carrying out any maintenance tasks. To depressurize the fill containment station, open the drain valve (a, Figure 6.).

Tank refill pressure is extremely high. Therefore, before refilling the tanks check that hoses are correctly connected and in good condition. Check also that the valves on any unused hoses are closed properly to prevent the dangers associated with hose whipping.

To change the tank refill hoses, proceed as follows:

- Disconnect the cylinder refill hoses by unscrewing the fittings (17 mm wrench).
- Replace the old hoses with new ones.
- Screw the hoses onto the connectors (a, Figure 7).
- Use a dynamometric wrench to tighten the hoses on the fill containment station with a torque of 15 Nm.

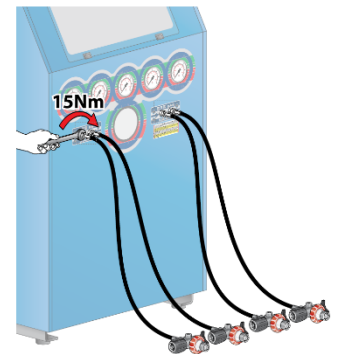

Figure 7. Tank refill hose change.



WARNING

When the tanks are being refilled, unauthorized personnel must remain at a distance of at least 3 meters (10 feet). It is strictly forbidden to disconnect the hoses from the fittings or refill valve when the machine is under pressure.

10.8 Dismantling and Putting the Fill Containment Station Out of Service

Should you decide not to use the fill containment station or any of its parts any longer you must precede with its dismantling and putting it out of service. These tasks must be carried out in compliance with the standards of your country or municipality.



WARNING

Should the fill containment station, or a part of it, be out of service its parts must be rendered harmless so they do not cause any danger.

11.0 Maintenance Register

11.1 Customer Service

Customers continue to receive assistance after the purchase of a fill containment station. To this end **Nuvair** has created a customer service network covering the entire country.

11.2 Scheduled Maintenance

The scheduled maintenance program is designed to keep your fill containment station in perfect working order. Some simple tasks, described in this manual, can be carried out directly by the customer; others, instead, require that the work be carried out by trained personnel. For the latter we recommend you always contact our office. This section provides a simple tool with which to request assistance and register completed scheduled maintenance work. Start-up and maintenance checks/tasks, once completed by our qualified technician, are registered in this maintenance chapter by way of an official stamp, signature, and inspection date; the number of working hours is also registered. The maintenance schedules/coupons easily let you know when our assistance service should be contacted to carry out work.

11.3 Nuvair Customer Care Contact

Telephone: +1.805.815.4044
 Fax: +1.805.486.0900
 E-mail: info@Nuvair.com
 Web: www.Nuvair.com/

12.0 Spare Parts List

Fill Containment Station System Components	Type	Part Number
SCBA Fill Whip & Valve for Containment Station	SCBA	NS-WHIP-SCBA
Regulator for Containment Station	High-Pressure	NS-REG
Oxygen Compatible Air (OCA) Filter Elements	Drying Filter Cartridge	X96677
	Breathing Air Filter	X96337
Filter Tower Wrench	Stainless Steel	TL-033

14.0 Appendix

14.1 Supply and Breathing Air Specifications

All supply and breathing air must meet the following requirements of CGA G-7.1-1997. Periodic air quality testing to assure compliance is recommended. All breathing air for diving produced by a downstream fill containment station must be purified to meet Grade E quality, and periodic air quality testing to assure compliance is mandatory.

Item	Grade D	Grade E
Oxygen	19.5-23.5%	20-22%
Carbon Dioxide (maximum)	1000 PPM	1000 PPM
Carbon Monoxide (maximum)	10 PPM	10 PPM
Hydrocarbons (maximum)	Not specified	25 PPM
Water Vapor (maximum)	Not specified	Not specified
Dew Point (maximum) ¹	Not specified	Not specified
Oil & Particles (maximum) ²	5 mg/m ³	5 mg/m ³
Odor	None	None

Notes: ¹ Dew point of supply air must be >10°F (6°C) colder than coldest ambient air expected.

² Supply air delivered to the membrane system must contain <0.003 PPM oil vapor.

14.2 Filter Element Life Factors

Breathing air filter element life is typically rated by manufacturer based on an air temperature of 80°F at the filter inlet. Under normal operation this temperature is +12°F (+5°C) warmer than the ambient air, resulting in an equivalent ambient temperature rating at +68°F (+20°C).

To determine element life at a different ambient temperature, multiply the rated life by the life factor listed below:

Filter Temperature	Ambient Temperature	Filter Element Life Factor
53°F (12°C)	41°F (5°C)	2.6 × Life
62°F (17°C)	50°F (10°C)	1.8 × Life
71°F (23°C)	59°F (16°C)	1.35 × Life
80°F (27°C)	68°F (20°C)	1 × Life
89°F (32°C)	77°F (25°C)	0.8 × Life
96°F (36°C)	84°F (29°C)	0.55 × Life
105°F (41°C)	93°F (34°C)	0.45 × Life
114°F (46°C)	102°F (39°C)	0.35 × Life

15.0 Nuvair Fill Containment Station System Warranty

Nuvair extends a limited warranty, which warrants the fill containment station system to be free from defects in materials and workmanship under normal use and service for a limited period. All other Original Equipment Manufacturer (OEM) components used in the system are warranted only to the extent of the OEM's warranty to Nuvair. Nuvair makes no warranty with respect to these OEM components, and only warrants the workmanship that Nuvair has employed in the installation or use of any OEM component. This warranty is not transferable.

Nuvair will, at its discretion and according to the terms as set forth within, replace or repair any materials which fail under normal use and service and do not exhibit any signs of improper maintenance, misuse, accident, alteration, weather damage, tampering, or use for any other than the intended purpose. Determination of failure is the responsibility of Nuvair, which will work together with the customer to adequately address warranty issues. When any materials are repaired or replaced during the warranty period, they are warranted only for the remainder of the original warranty period. This warranty shall be void and Nuvair shall have no responsibility to repair or replace damaged materials resulting directly or indirectly from the use of repair or replacement parts not approved by Nuvair.

Maintenance Items

Any materials which are consumed, or otherwise rendered not warrantable due to processes applied to them, are considered expendable and are not covered under the terms of this policy. This includes maintenance and consumable items listed as part of a suggested maintenance program included with system documentation.

Return Policy

Application for warranty service can be made by contacting Nuvair during regular business hours and requesting a Return Material Authorization (RMA) number. Materials that are found to be defective must be shipped, freight prepaid, to the Nuvair office in Oxnard, California USA. Upon inspection and determination of failure, Nuvair shall exercise its options under the terms of this policy. Warranty serviced materials will be returned to the customer via Nuvair's preferred shipping method, at Nuvair's expense. Any expedited return shipping arrangements to be made at customer's expense must be specified in advance.

Limitation of Warranty and Liability

Repair, replacement, or refund in the manner and within the time provided shall constitute Nuvair's sole liability and the purchaser's exclusive remedy resulting from any nonconformity or defect. Nuvair shall not in any event be liable for any damages, whether based on contract, warranty, negligence, strict liability or otherwise, including without limitation any consequential, incidental, or special damages, arising with respect to the equipment or its failure to operate, even if Nuvair has been advised of the possibility thereof. Nuvair makes no other warranty or representation of any kind, except that of title, and all other warranties, express or implied, including warranties of merchantability and fitness for a particular purpose, are hereby expressly disclaimed. No salesman or other representative of Nuvair has authority to make any warranties.

Additional Record of Changes

It is the responsibility of the owner of this product to register their ownership with Nuvair by sending the warranty card provided to Nuvair. This card is to establish registration for any necessary warranty work and as a means of communication that allows Nuvair to contact the user regarding this product.

The user must notify Nuvair of any change of address by the user or sale of the product. All changes or revisions to this manual must be recorded in this document to ensure that the manual is up to date.

Change Date	Description of Change



	Nuvair
Phone	+1.805.815.4044
Fax	+1.805.486.0900
Address	1600 Beacon Place Oxnard, CA 93033 USA
Email	info@nuvair.com
Website	www.Nuvair.com

Rev. 08.2022
SKU NSS Series