



User Manual

Pro 4 Warn Analyzer™

Rev. 08.22

If you have any questions on this equipment please contact Technical Support at:

Nuvair
1600 Beacon Place
Oxnard, CA 93033

Phone: 805-815-4044
FAX: 805-486-0900
Email: info@nuvair.com

Hours: Monday through Friday
8:00 AM to 5:00 PM PST USA

Warning

This Operation Manual contains important safety information and should always be available to those personnel operating this equipment. Read, understand, and retain all instructions before operating this equipment to prevent injury or equipment damage.

Every effort was made to ensure the accuracy of the information contained within this manual; however, we retain the right to modify its contents without notice. If you have problems or questions after reading the manual, stop and call for information.

Warning

Never expose gas sensors to pressure or you may cause damage and/or false readings. Damaged sensors will not provide accurate gas analysis. Most gas analyzers can be used to analyze a regulated gas sample flow, the contents of a gas cylinder, or the flow from a regulator. The flow rate of gas must equal 1-5 L/min. To produce this flow, a Flow Restrictor and Regulator may be required. A faulty Flow Restrictor can lead to a false analyzer reading. Flow Restrictors should be regularly tested with a Flow Meter. Inaccurate gas analysis can lead to serious personal injury or death.

Table of Contents

1.0 Introduction	4
2.0 System Description	5
2.1 Identification of Analyzer Components	6
2.2 Oxygen Sensor	6
2.3 Moisture Sensor	6
2.4 Sensor	6
2.5 Batteries	6
2.6 Flow Adapter Cap	7
3.0 Requirements for Operation	7
4.0 Calibration	8
4.1 Sample Flow Method	9
4.2 Programming Procedures	10
4.3 Alarm Setting	11
4.4 Full Scale Value Setting	11
4.5 PrE Pressure Value	11
5.0 Operation	12
6.0 Threshold Alarms	12
7.0 Powering Off	12
8.0 Factory Reset	12
9.0 Maintenance	13
9.1 Analyzer Care	13
9.2 Battery Replacement	13
9.3 Sensor Replacement	14
10.0 Spares and Accessories	14
10.1 Calibration Equipment	14
11.0 Troubleshooting	14
12.0 Relay Output Schematics	15
13.0 Analyzer Specifications	16
Warranty	48
Record of Changes	49

1.0 Introduction

This manual will assist you in the proper set-up, operation and maintenance of the Pro 4 Warn Analyzer. Be sure to read the entire manual.

Throughout this manual we will use certain words to call your attention to conditions, practices or techniques that may directly affect your safety. Pay particular attention to information introduced by the following signal words:

Danger

Indicates an imminently hazardous situation, which if not avoided, will result in serious personal injury or death.

Warning

Indicates a potentially hazardous situation, which if not avoided, could result in serious personal injury or death.

Caution

Indicates a potentially hazardous situation, which if not avoided, may result in minor or moderate injury. It may also be used to alert against unsafe practices.

Notice

Notifies people of installation, operation or maintenance information which is important but not hazard-related.

Warnings Graphics Defined:



Gas Inhalation



Skin damage

Abbreviations commonly used in this manual:

CO Carbon Monoxide
CO% Carbon Monoxide Percentage of Gas
PPM Parts Per Million
PSI Pounds Per Square Inch
HT High Temperature

H₂O Water (Moisture)
L.P. Low Pressure
H.P. High Pressure
L/min Liters Per Minute

2.0 System Description

The Nuvair Pro 4 Warn Analyzer measures water (H₂O), Oxygen (O₂), Carbon Dioxide (CO₂), and Carbon Monoxide (CO) levels in a range of gases. In addition a High Temp monitor will alarm if the compressor gets too hot. All Analyzers are in a water and impact resistant case with a clear cover that allows for viewing of all gas displays, visual alarms and easy access to analyzer controls that is compatible with outdoor and marine environments.

The Analyzer is AC powered with a battery backup that can operate the analyzer for 3-4 hours. Includes internally mounted Sensors all tied together to monitor the flow of your compressors gas. The Analyzers use a flow restrictor to deliver sample gas to the sensors. Pressurized gases must be regulated down to avoid damage to the analyzer.

The Analyzer has visual & audible alarms for each of the gases monitored and high temperature of the compressor. Pizo audible alarm will sound if any of the set alarms are tripped bringing attention to the Pro 4 Warn Analyzer.

It is ready for use after calibration with an appropriate certified calibration gas.

Warning

This analyzer is designed for use at atmospheric pressures only. It is not designed for exposures in a hyperbaric chamber. Use of this analyzer in a hyperbaric chamber will result in incorrect readings and may damage the unit.

Warning

Although the Analyzer is a rugged instrument, careless handling or abuse may result in damage to the Analyzer resulting in inaccurate gas analysis. Inaccurate gas analysis can lead to serious personal injury or death.

Notice

Extreme Gas exposure levels directed at the Analyzer sensors may damage the sensors.

2.1. Identification of Analyzer Components



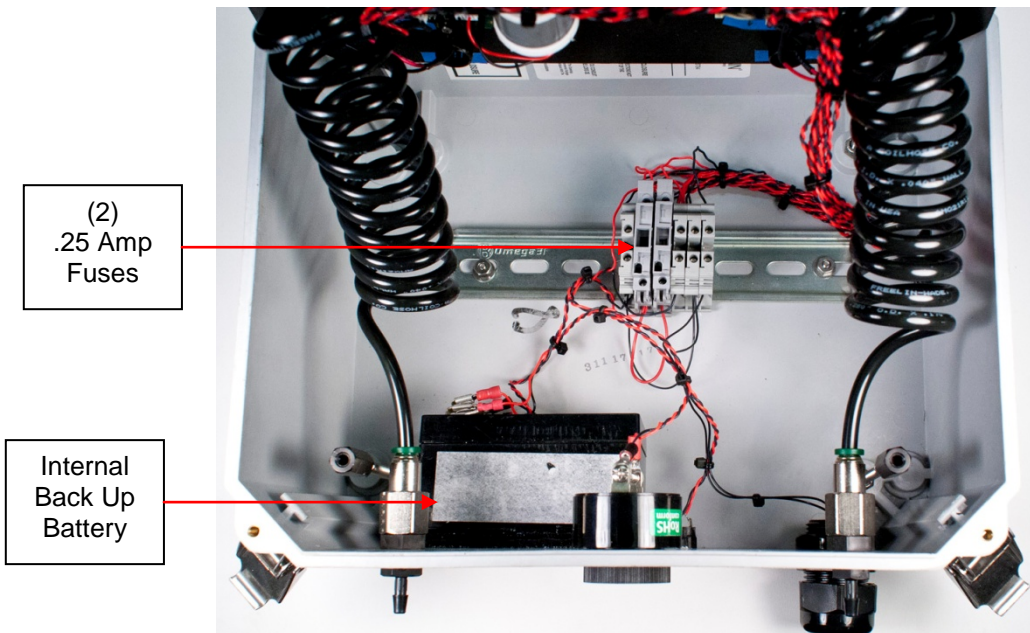
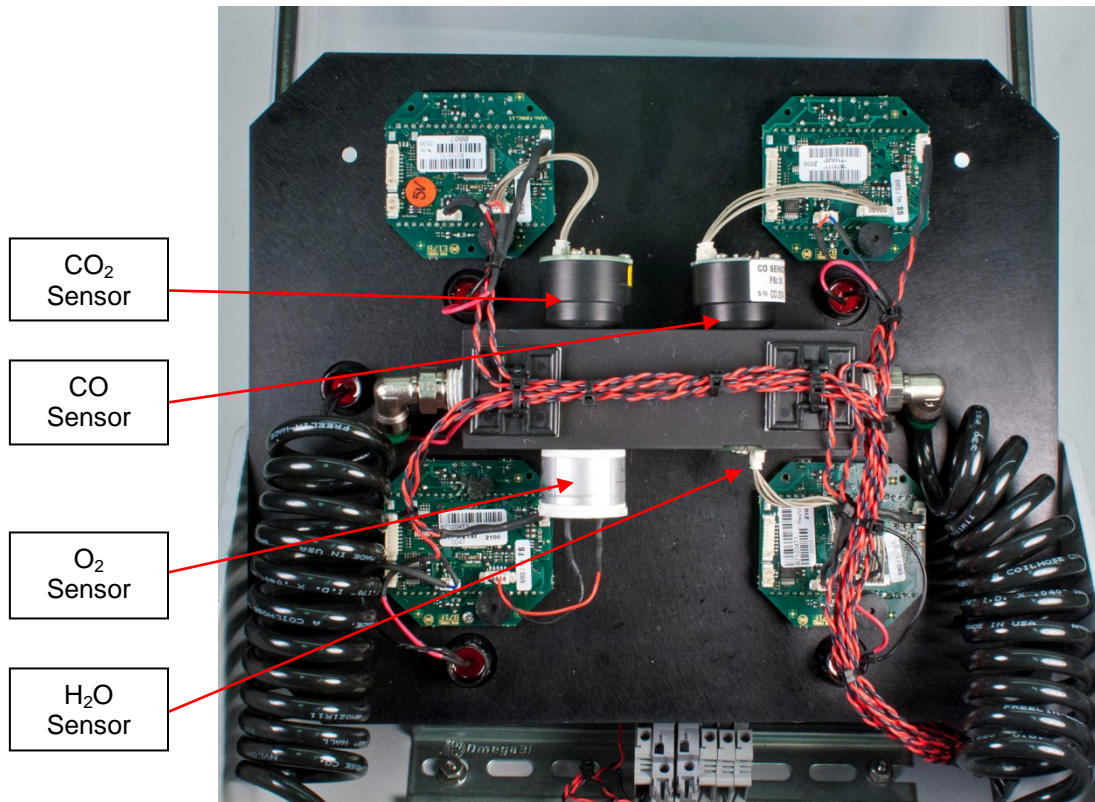

Individual Specifications of the Analyzers in the Pro 4 Warn.

2.2. – Oxygen Sensor:

Sensor Type:	Electrochemical (Galvanic)
Electrical Connector:	3.5 mm Molex Jack
Range:	0-100.0% Oxygen (0-1 ATA PPO ₂)
Display Accuracy:	+/- 0.1%
Expected Sensor Life, Room Air:	0-24 Months @ ambient air
Output Signal:	11+- 3 millivolt @ dry ambient air 74°F (23°C)
Power:	9V Alkaline Battery
Response Time:	Less Than 12 Seconds
Drift:	< 1% volume O ₂ / month @ air
Operating Temperature:	32-104°F (0-40°C)
Storage Temperature:	recommended:41 to 86°F (5 to 30°C) maximum -4 to122°F (-20 to 50°C)
Pressure:	750 to 1250 hPa
Linearity Error:	= 2% @ 100% O ₂ applied for 5 min.
Zero Offset Voltage:	= 200 uV in 100% N ₂ , applied for 5 min.
Influence of Humidity:	-0.03% rel. O ₂ reading /%RH
Humidity:	up to 100% RH
Temperature Compensation:	NTC
Interferences:	according to DIN EN 12598 and ISO 7767
Material in contact media:	PA, PPS, PTFE, stainless steel
Warranty:	12 Months

In the interest of product improvement these design specifications may change without notice.

Note: All specifications are at ambient / sea level, 77°F / 25°C

2.3. – Moisture Sensor:

Relative Humidity Range:	0 – 100% relative humidity
Resolution:	0.5% relative humidity
Display Accuracy:	± 2%(10 to 40 °C & 10 to 90 %rh) (±97 mg/m ³ at 0°C)
Additional error temperature:	± 0.1 % rh/K for less than 10 °C and greater than 40 °C
Additional error rh:	±0.25% rh/%rh for less than 10% rh and greater than 90% rh

Relative Humidity Sensor Type:	Capacitive
Expected Sensor Life, Room Air:	5+ Years
Power:	24V DC
Response Time:	
Stabilization Time:	
Operating Temperature:	-4 to 176°F (-20 to 80°C) – Will work outside this range with decreased accuracy.
Storage Temperature:	
Operating Pressure:	Not to Exceed 1 Atmosphere Absolute (0 P.S.I.)

Note: All specifications are at ambient / sea level, 77°F / 25°C

2.4. – Carbon Dioxide Sensor:

Resolution:	0 – 2500 (50ppm) CO ₂
Alarm Set Point:	Whatever ppm desired of CO ₂
Display Accuracy:	+/- 5%
Sensor Type:	NDIR non-dispersive infra red
Expected Sensor Life, Room Air:	2 Years
Power:	9 Volt Battery or optional 110/230v electric
Battery Life:	9V Alkaline = 3 hours, 9V Lithium = 6 hours
Response Time:	Less Than 50 Seconds to 90% of Final Value
Stabilization Time:	10 Minutes Max Accuracy
Operating Temperature:	41 to 104°F (5 to 40°C)- Will work outside this range with decreased accuracy.
Storage Temperature:	14 to 140°F (-10 to 60°C)
Operating Pressure:	Not to Exceed 1 Atmosphere Absolute (0 P.S.I.)
Humidity:	15-90% Continuous 0-99% Intermittent

Note: All specifications are at ambient / sea level, 77°F / 25°C and subject to change without notice

2.5. – Carbon Monoxide Sensor:

Range:	0 – 100 ppm CO
Alarm Set Point:	10 ppm CO
Display Accuracy:	+/- 5%
Sensor Type:	Electrochemical
Expected Sensor Life, Room Air:	2 Years
Power:	1 9 Volt Battery
Response Time:	Less Than 50 Seconds to 90% of Final Value
Stabilization Time:	15 Minutes when First Installed
Operating Temperature:	41 to 104°F (5 to 40°C)- Will work outside this range with decreased accuracy.
Storage Temperature:	14 to 140°F (-10 to 60°C)
Operating Pressure:	Not to Exceed 1 Atmosphere Absolute (0 P.S.I.)
Humidity:	15-90% Continuous 0-99% Intermittent

Note: All specifications are at ambient / sea level, 77°F / 25°C

3.0 Requirements for Operation of Pro 4 Warn

The Pro 4 warn analyzer is designed to be placed in line with your current compressor package and will require the user to provide the following connections for installation.

1. Constant gas flow reduced to 4 liters per minute.
2. 110V AC Outlet for powering the analyzer.
3. Installation of the High Temp sensor in your existing compressor package and cable attached to Pro4Warn.

3.1. Gas Flow

Before using the Pro 4 Warn Analyzer you must connect the analyzer to your compressor system by diverting gas to the analyzer. This will require the use of a flow restrictor to reduce the gas to 4 liters per minute input. Nuvair can provide a flow restrictor for this purpose that is pre-set at 4 Lpm.



3.2. AC Power

Use the provided AC power supply to plug into 110V power.



3.3. High Temp Sensor (If Equipped)

The Analyzer includes an audible and visual alarm that is activated when the temperature exceeds the factory setting of 350°F. The alarm will not clear until the temperature drops below 350°F.



3.4. Gas Sensors

The Pro4Warn uses 4 individual analyzers and sensors to measure content in gases of O₂, Moisture, CO₂ and CO. These Sensors are disposable and user-replaceable, with a life expectancy of 24 to 60 months depending on the Gas. The Sensors are designed for use at atmospheric pressure (0 P.S.I.). The gas mixture to be analyzed must be regulated accordingly, and any potential for pressure or vacuum must be avoided.

3.5. Battery Back Up (If Equipped)

One 12-volt 1.3 Amp sealed lead acid battery provides back up power. The battery is located inside the Analyzer and is user-replaceable. The battery should be removed any time the Analyzer will be stored without use for extended periods of time. Each of the analyzers will flash a warning screen from "000" to "bAt" at start up when battery is low.

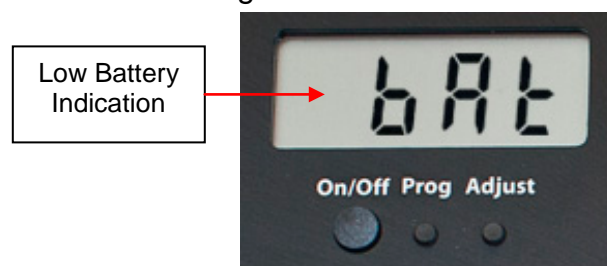

4.0 Calibration

Analyzer calibration must be verified on a monthly basis. Improper calibration may result in an incorrect reading, delivering inaccurate levels of gas or moisture being monitored.

Nuvair offers two gas testing kits for the Pro4Warn. A moisture free gas is necessary for testing the moisture monitor. A Helium free gas is used for the gas analyzers in the Pro4Warn.

See addendum for more information.

Moisture Monitor Test Gas must not contain Moisture for calibration to succeed.

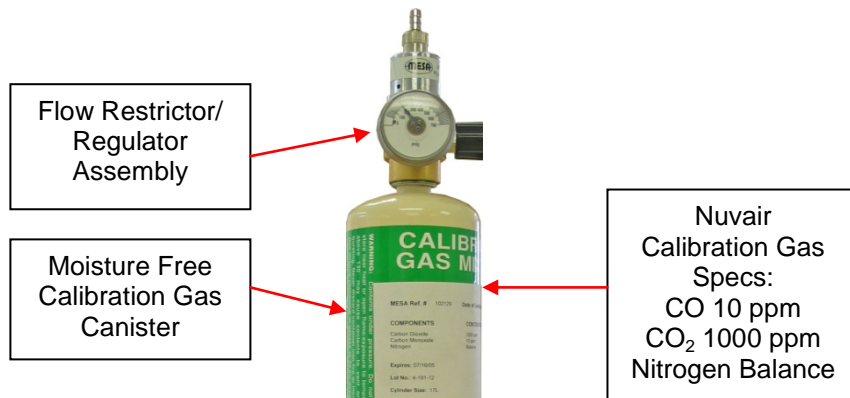

Warning

Analyzer calibration must be verified on a monthly basis. Improper calibration may result in an incorrect reading, delivering inaccurate levels of gases or moisture being monitored.

Warning

This Analyzer must always be checked with a calibration gas and used with gases regulated and supplied at atmospheric pressure (0 P.S.I.). Use of gases at higher pressures may result in incorrect readings and may damage the Analyzer. Inaccurate gas analysis can lead to serious personal injury or death.

Warning

Checking Calibration or use of the Analyzer with a low battery may result in inaccurate readings. Inaccurate gas analysis can lead to serious personal injury or death.

Notice

If the Analyzer has been subjected to a recent change in ambient temperature, allow it to stabilize for one hour before checking calibration.

Verify calibration on a monthly basis. Breathing gas applications require the use of a certified calibration gas with no moisture concentration and flow rate of 4 L/min. The equipment to produce this flow is available from Nuvair. See Spares and Accessories section.

To assure the greatest accuracy for other applications, use the calibration gas concentration closest to the expected concentration in the gas being measured.

5.0 Operation of Pro 4 Warn

Prior to each Analyzer use:

- 1) Turn the analyzers on (hold on/off for 3 sec) and monitor the display for a low battery warning. Replace battery immediately if warning appears. Once fully cycled the screens should display digits.



- 2) The displays will cycle through a couple screens before settling into the readings of the current gas. Each of the Analyzers act independently within the enclosure and will display data in accordance to their individual readings. User must read and consult the each analyzer section in this manual to understand responses of each analyzer.

Warning

Gas, even under moderate pressures, can cause extreme bodily harm. Never allow any gas stream to be directed at any part of your body.

Warning

Never expose the sensor to pressures above atmospheric pressure (0 P.S.I.) or you may cause damage to the sensor and/or receive false readings. Damaged Sensors will not provide accurate gas analysis. Inaccurate gas analysis can lead to serious personal injury or death.

Warning

It is very important that the calibration take place at atmospheric pressure (1 bar) and with calibrated test gas that has no moisture in it.

- 3) Threshold Alarms

“Each Analyzer has independent threshold alarms that are user programmable”.

User should confirm each of the threshold alarms programmed in the analyzers matches the desired value of the gas to be analyzed.

- 4) Powering off hold down the On/Off button for a couple of seconds on each of the analyzers in the Pro 4 Warn. The Analyzer will display “OFF” and then go blank.

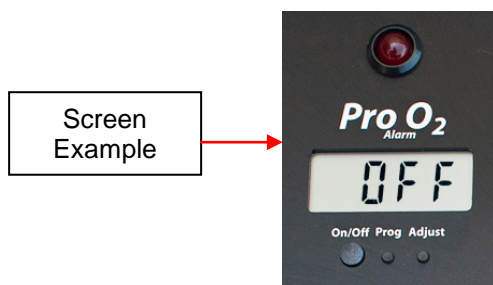

6.0 Factory Reset

In case it is necessary to reset any of the Analyzers to their factory settings, power on the Analyzer pressing at the same time for more than one second the “On/Off” and “Adjust” buttons. On the display will appear “res” and the instrument will go to the reading page.

Warning

Resetting the Analyzer will result in all user programmed alarms and calibration being erased and set at factory defaults.

7.0 Maintenance

7.1. Analyzer Care

Warning

Analyzers immersed in liquid or stored in wet environments may not operate properly. This may result in incorrect readings. Incorrect gas analysis may result in personal injury or death.

Warning

Protect the analyzer from excessive shock and impact. Excessive shock and impact may result in incorrect readings. Incorrect gas analysis may result in personal injury or death.

Warning

Protect the analyzer from exposure to hyperbaric environments. Exposure to hyperbaric environments may result in incorrect readings. Incorrect gas analysis may result in personal injury or death.

- Do not clean Analyzer with anything other than a damp soft cloth.
- Do not immerse in liquid, leave unprotected outside, or store in a wet environment.
- Protect Analyzer from excessive shock and impact.
- Protect Analyzer from excessive exposure to sunlight and extreme temperatures.
- Do not use the Analyzer in a hyperbaric environment.

7.2. Battery Replacement (If Equipped)

Notice

Be sure to dispose of spent, leaking, or damaged Battery properly, according to local regulations.

The following pictures illustrate the steps required to replace the batteries in the Analyzer.

1. Unplug battery
2. Pull battery away from housing
3. Replace with 12 Volt 1.3 Amp battery.

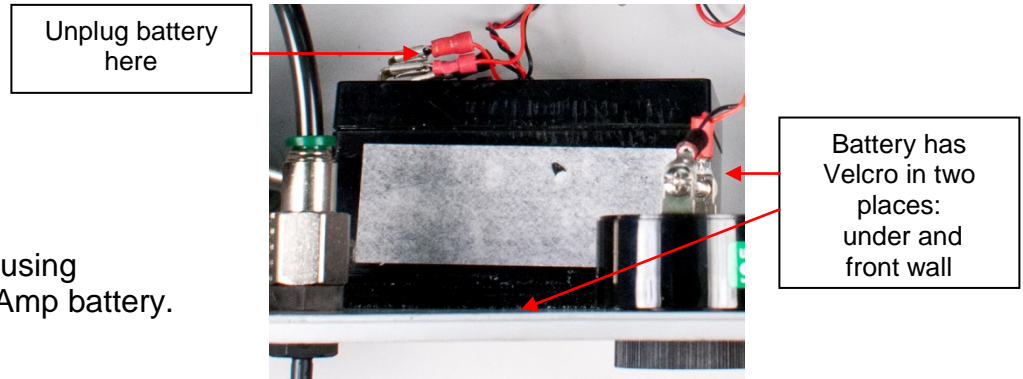

7.3. Sensor Replacement

The Pro4Warn has four user changeable sensors with good dynamic performance long term stability and highly resistant to dew. These sensors have various life expectancies and should be replaced immediately if accuracy is of concern. If damage occurs send the analyzer back to Nuair for inspection and Nuair will determine if the unit can be repaired or needs to be replaced.

8.0 Programming each of the Analyzers in the Pro4Warn

The proceeding sections will outline the operation of each of the individual analyzers. There are similarities in how each of the analyzers operate and are programmed. Take extra care in reading the sections especially the alarm settings as each has a different program for tripping the alarms. In some cases the alarms are tripped upon reaching the set value and in others the alarm is tripped until the set value is reached. Refer back to the section associated to the analyzer you are programming whenever possible to confirm the proper alarm settings are being programmed.

9.0 Pro O₂ Alarm Analyzer

The Pro O₂ alarm™ Oxygen analyzer measures oxygen (O₂) levels in gases in the range of 0.0 to 100%. The Analyzer is designed to verify O₂ concentration in stored gas cylinders, enclosed spaces and with compressors pumping nitrox. When used in breathing gas applications, redundant Analyzers must be used for verification. In diving, for example, one Analyzer must be used to monitor oxygen during breathing gas production and a second independent Analyzer must be used to verify the oxygen content of the breathing gas prior to diver use.

Warning

When using the Analyzer for diving applications with mixed gases other than air, you must first obtain proper instruction from a certified diving instructor with a nationally recognized training agency qualified in mixed gas diving. Improper use of this analyzer may result in incorrect gas analysis which can lead to serious personal injury or death.

Pro 4 Warn Analyzer

The Analyzer includes an internally mounted Sensor with audible and visual alarms. Large Digital Display and controls are environmentally sealed.

The Analyzer uses a regulated flow of gas within the analyzer to deliver sample gas to the sensor. Pressurized gases must be regulated to avoid damage to the analyzer. Use of this Analyzer in a hyperbaric chamber will void the owner's warranty.

The Analyzer comes in a high impact storage case. It is ready for use after calibration with appropriate certified calibration gases.

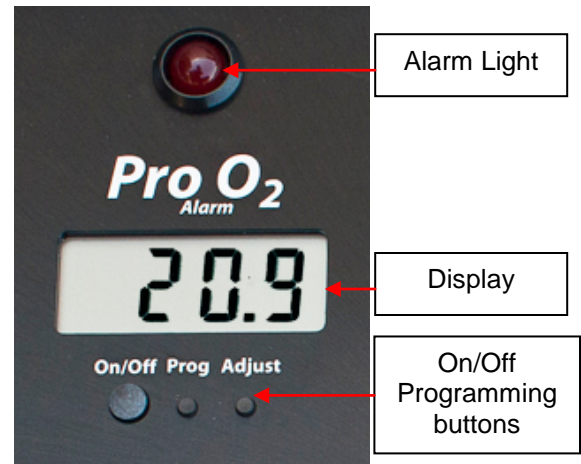

Warning

This analyzer is designed for use at atmospheric pressures only. It is not designed for exposures in a hyperbaric chamber. Use of this analyzer in a hyperbaric chamber will result in incorrect readings and may damage the unit.

Warning

Although the Analyzer is a rugged instrument, careless handling or abuse may result in damage to the Analyzer resulting in inaccurate gas analysis. Inaccurate gas analysis can lead to serious personal injury or death.

Warning

Breathing gas must always be analyzed by two separate Analyzers, with one used for production and one used for analysis after production. Never depend on a single Analyzer during both gas production and delivery. If the Analyzer readings do not agree, both units must be recalibrated. Inaccurate gas analysis can lead to serious personal injury or death.

9.1. Pro O₂ Analyzer Controls

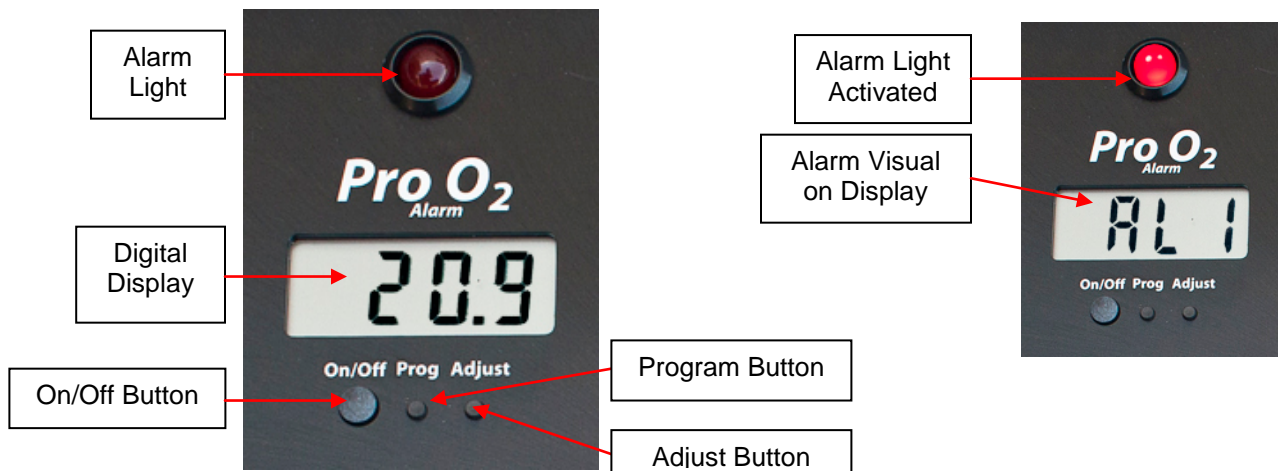

9.2. O₂ Analyzer Display

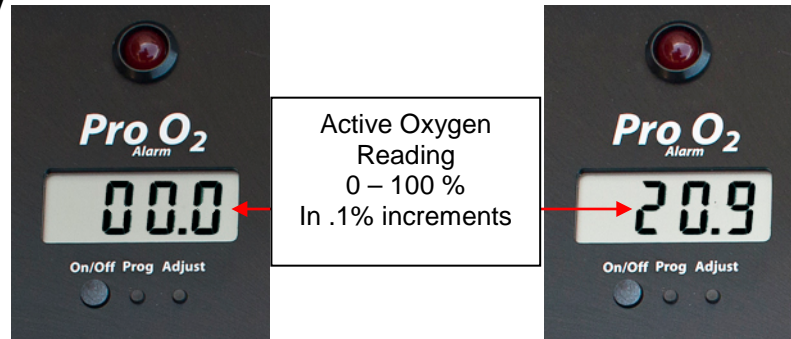

9.3. O₂ Analyzer Alarm

The Analyzer includes an audible alarm that is activated when the sensor reaches a user programmed minimum % of oxygen and maximum % of oxygen. The alarm will not clear until the concentration of O₂ moves into the threshold programmed by the user.

9.4. O₂ Analyzer Sensor

The Analyzer uses an electrochemical O₂ sensor to measure O₂ content in gases. The sensor is disposable and user-replaceable, with a life expectancy of up to 24 months depending on usage. The sensor is designed for use at atmospheric pressure (0 P.S.I.). The gas mixture to be analyzed must be regulated accordingly, and any potential for pressure or vacuum must be avoided.

9.5. O₂ Analyzer Calibration

Warning

Oxygen Analyzers must be calibrated before each use. Improper calibration may result in the use of incorrect breathing gas mixtures, which may cause serious injury or death to the person using the gas mixture.

Warning

Calibration or use of the Analyzer with a low battery may result in inaccurate readings. Inaccurate gas analysis can lead to serious personal injury or death.

Warning

When Analyzer calibration is performed at different atmospheric conditions than the gas being measured, a calibration correction value may be required. Improper calibration may result in the use of incorrect breathing gas mixtures, which may cause serious injury or death to the person using the gas mixture.

Notice

If the Analyzer has been subjected to a recent change in ambient temperature, allow it to stabilize for one hour before checking calibration.

Warning

During the warm up time if the oxygen percentage of the mixed gas flow is different from the value of calibration set in the instrument, a failed calibration is obtained and a wrong analysis value will be displayed.

9.6. Pro O₂ Calibration Methods

Calibration should always be performed at the same temperature and humidity conditions as the gas being measured. This is not always possible, for example, in a tropical environment where dry breathing gas from a high-pressure scuba cylinder will be measured after Analyzer calibration has been performed in the warm, humid ambient air. Under these conditions a calibration correction value may be required, or dry air must be used for calibration. It may be required for the analyzer to be auto calibrated to a certified calibration gas.

Warning

Obtain proper training before attempting special calibration procedures. Improper calibration may result in the use of incorrect breathing gas mixtures, which may cause serious injury or death to the person using the gas mixture.

To assure the greatest accuracy for other applications, use the calibration gas concentration closest to the expected concentration in the gas being measured.

9.7. Pro O₂ Analyzer Operation

Prior to each Analyzer use:

- 3) Turn unit on by holding on/off button for 2 sec, until display shows “On”, after that the “Att” (Wait) message will be displayed for about 4 seconds, then the sensor auto-calibration procedure is started.
- 4) The auto-calibration last about 5 seconds; during this time the display will show the message “CAL” and “Att” alternatively. Be sure during this time the exposed to the gas mix with oxygen percentage as programmed in the O2c (calibration) parameter (SEE PROGRAMMING PROCEDURE). By default, for simplicity, the O2c value is set at 21% that corresponds to the percentage of Oxygen in free air. Before switching on and during the warm up time gas must be flowing over sensor for proper calibration.
- 5) At the end of the warming up and calibration time, the display will show the blinking value in mV read from the oxygen sensor during calibrations: the instrument is now ready to read oxygen concentration of the gas.
- 6) Connect the sensors flow adaptor to the gas. The flow rate of gas must equal 1 – 5 L/min. To produce this flow, a Flow Restrictor and Regulator may be required. See Spares and Accessories section. The display will now read the oxygen content continuously of the gas flow.
- 7) While the analyzer is displaying the oxygen percentage press the calibrate button for more than 1 second to initiate the mV output display mode. It is important to periodically monitor this value in order to confirm the sensor is working properly and not expired.

⚠ Warning

Gas, even under moderate pressures, can cause extreme bodily harm. Never allow any gas stream to be directed at any part of your body.

Tip: You can check the battery life and current temperature by holding Adjust button for 3 seconds. The display will alternate from battery life to current temperature (Celsius) twice before returning the home screen.

⚠ Warning

Never expose the sensor to pressures above atmospheric pressure (0 P.S.I.) or you may cause damage to the sensor and/or receive false readings. Damaged Sensors will not provide accurate gas analysis. Inaccurate gas analysis can lead to serious personal injury or death.

9.8. Programming Procedures

Keep the “Pro” button pressed for more than two seconds and then release the button. “Pr” should display for two seconds and then the display will change to AL 1 and alternate with the 3 digit set value.

It is possible to program:

- **AL 1** Minimum alarm point expressed in % of oxygen concentration
- **AL 2** Maximum alarm point expressed in % of oxygen concentration
- **FSC** Value expressed in % of oxygen concentration corresponding to the current output full scale value (20mA). 20mA always correspond to 100 % oxygen concentration.
- **O2c** Oxygen sensor calibration point

At the end of the programming procedure the display will show “End” and the instrument will display the oxygen content of the gas mix.

Below are the actual screen views of each of the modes.

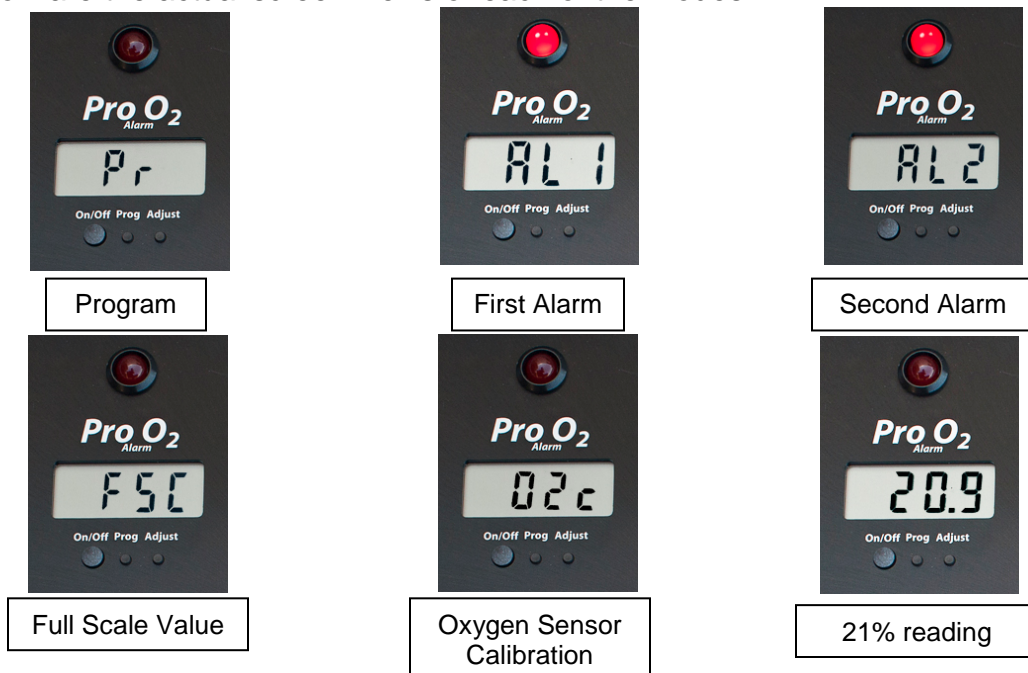

9.9. Alarm Setting (AL 1 & AI 2)

- 1.) Press the “Pro” button for more than two seconds and then release the button.
On the display will appear “Pr” for two seconds, then “AL1” will appear and be ready for changing the value of the first alarm point. After a second the display will show the value of “AL1” O₂% (0% default) current setting.
- 2.) The blinking digit shows the cursor position.
- 3.) Press the “Pro” button to increase the value (from 0 to 9)
- 4.) Press the “Adjust” button to move the cursor to the next digit, the “Adjust” button will be used to cycle through the rest of the digits.
- 5.) To complete your entry and save the O₂% value, press the “On/Off” button. You will then automatically jump to “AL 2” programming view.
- 6.) Repeat steps 3 through 5 to modify and save the “AL 2” O₂% desired value (100% default).
- 7.) Once programming of “AL 2” is complete you will be in the “FSC” Value Screen and ready for programming this value. To jump to the end continue to press the “On/Off” button until the end screen appears.

9.10. Full Scale Value Setting (FSC)

Once the alarms have been set the Pro O₂ Alarm Analyzer goes to “FSC” view so that you can change the analog full scale value. It is not necessary to modify this value which is factory set at 100. This is the Oxygen concentration corresponding to 20 mA on the analog output. 4mA is the value at 0% of Oxygen. This value can be changed in the same manner as the Alarm settings:

- 1.) Press the “Pro” button for more than two seconds and then release the button.
On the display will appear “Pr” for two seconds, then “AL 1” will appear. Press the On/Off button to cycle through the Alarm settings until you reach the “FSC” view. The “FSC” screen and a 3 digit value will alternate for a few seconds and the Pro O₂ Alarm Analyzer will be ready for adjusting the “FSC” Value.
- 2.) The blinking digit shows the cursor position.
- 3.) Press the “Pro” button to increase the value (from 0 to 9)
- 4.) Press the “Adjust” button to move the cursor to the next digit, the “Adjust” button will be used to cycle through the rest of the digits.
- 5.) To complete your entry and save the FSC value, press the “On/Off” button. You will then automatically jump to “O2c” programming view. To continue pass this to the end press the On/Off button until the “End” screen appears.

9.11. Calibration Oxygen Value (O2c)

After the “O2c” is set the Pro O₂ Alarm Analyzer goes to “O2c”, this is the current Oxygen calibration value default is 21%. It is not necessary to modify this value. The display alternates between “O2c” and the current value (21% default).

Press the “Pro” button for more than two seconds and then release the button.

On the display will appear “Pr” for two seconds, then “AL 1” will appear. Use the On/Off button to cycle through the various settings until you reach the “O2c” screen.

The 3 digit value will alternate with the “O2c” screen for a few seconds and the Pro O₂ Alarm Analyzer will be ready for adjusting the “O2c” Value.

- 1.) The blinking digit shows the cursor position.
- 2.) Press the “Pro” button to increase the value (from 0 to 9)
- 3.) Press the “Adjust” button to move the cursor to the next digit, the “Adjust” button will be used to cycle through the rest of the digits.
- 4.) To complete your entry and save the O2c value, press the “On/Off” button. You will then automatically jump to the “End” screen.

Warning

The oxygen calibration value will be the same value of the calibration set when the instrument is switched on. During the warm up time if the oxygen percentage of the gas flowing across the sensor is a different value of calibration set in the instrument, a failed calibration is obtained and the wrong gas percentage will be displayed. Wrong oxygen analysis may lead to death.

Warning

The calibration value of the Pro O₂ alarm is factory set at 21% and any adjustments to this value will change the analyzers ability to properly ready the % of oxygen in a gas. A wrong value in this parameter will give a wrong reading of O₂ concentration and the instrument will not be accurate. All the analysis concentration shown on the display will be wrong. If you modify this setting you must test the analyzer for accuracy with certified testing gas. Do not modify this value. Wrong oxygen analysis may lead to death.

9.12. Threshold Alarms

Should the Oxygen reading go over the threshold alarms (AL1 or AL2) the instrument will go into alarm mode and will activate the (optional) relays output (open collector max 100mA) and the internal buzzer. The display will show the trespassed alarm and the actual measured value. To stop the audible alarm, press any key. In this event the Pro O₂ alarm Analyzer will remain in alarm mode until the analyzed value goes below the alarm.

The relay output typically is used to shut down the compressor. Nuvair can supply the necessary components to adapt your compressor to the relay or provide them at the time of install on a new compressor.

9.13. Powering on and warming up

Press the On/Off button for more than one second, until the display shows “on”, after that the “Att” (wait) message will be displayed for about 4 seconds, then the sensor auto-calibration lasts about 5 seconds; during this time the display will show the messages ”CAL” and “Att” alternatively.

Be sure that during this time the sensor is exposed to the gas mix with the oxygen percentage as programmed in the “O2c” parameter (see programming procedure). By default the parameter is set at 21% by default that corresponds to the percentage of oxygen in free air, be sure that the air flow at this time across the sensor is 21% oxygen before turning on the analyzer.

Warning

During the warm up time if the oxygen percentage of the gas flowing across the sensor is a different value of calibration set in the instrument, a failed calibration is obtained and the wrong gas percentage will be displayed. Wrong oxygen analysis may lead to death.

9.14. Powering Off

At the home or gas reading screen, hold down the On/Off button for a couple of seconds. The Analyzer will display “OFF” and then go blank.



9.15. Factory Reset

In case it is necessary to reset the Pro O₂ Alarm Analyzer to the factory settings, power on the Analyzer pressing at the same time for more than one second the “On/Off” and “Adjust” buttons. On the display will appear “res” and the instrument will go to the reading page.

⚠ Warning

In case of reset, the instrument will delete all the alarms settings, the full scale value, and any new conversion value of Oxygen sensor will be reset to factory settings. Before using again the instrument, it may be necessary to program again the alarm values, the full scale value, and the Oxygen sensor calibration if changed. All the analysis concentration shown on the display would be wrong. Wrong Oxygen analysis may lead to death.

10.0 Pro H₂O Moisture Monitor

The Pro H₂O™ Moisture Analyzer measures water (H₂O) levels in gases ranging from 0 to 1999 parts per million (ppm). It can be used to measure the water content in gas mixes that will increase with humidity and moisture saturation of filters. The Analyzer is designed to verify H₂O concentration in stored gas cylinders as well as to monitor continuous gas flow from a compressor.



⚠ Danger

As soon as the analyzer alarm is tripped shut down your compressor system and replace all of your filter cartridges in the compressor system.

The Analyzer includes an internally mounted Sensor with audible and visual alarms. Large Digital Display and controls are environmentally sealed.

The Analyzer uses regulated flow within the analyzer to deliver sample gas to the sensor. Pressurized gases must be regulated to avoid damage to the analyzer. Use of this Analyzer in a hyperbaric chamber will void the owner’s warranty.

The Analyzer comes in a high impact storage case. It is ready for use after calibration with an appropriate certified calibration gas.

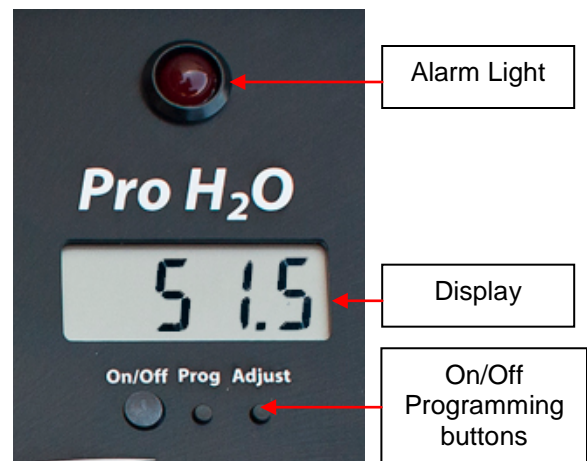

⚠ Warning

This analyzer is designed for use at atmospheric pressures only. It is not designed for exposures in a hyperbaric chamber. Use of this analyzer in a hyperbaric chamber will result in incorrect readings and may damage the unit.

⚠ Warning

Although the Analyzer is a rugged instrument, careless handling or abuse may result in damage to the Analyzer resulting in inaccurate gas analysis. Inaccurate gas analysis can lead to serious personal injury or death.

! Notice

Extreme H₂O exposure levels directed at the Analyzer sensor may damage the sensor.

10.1. Pro H₂O Analyzer Controls

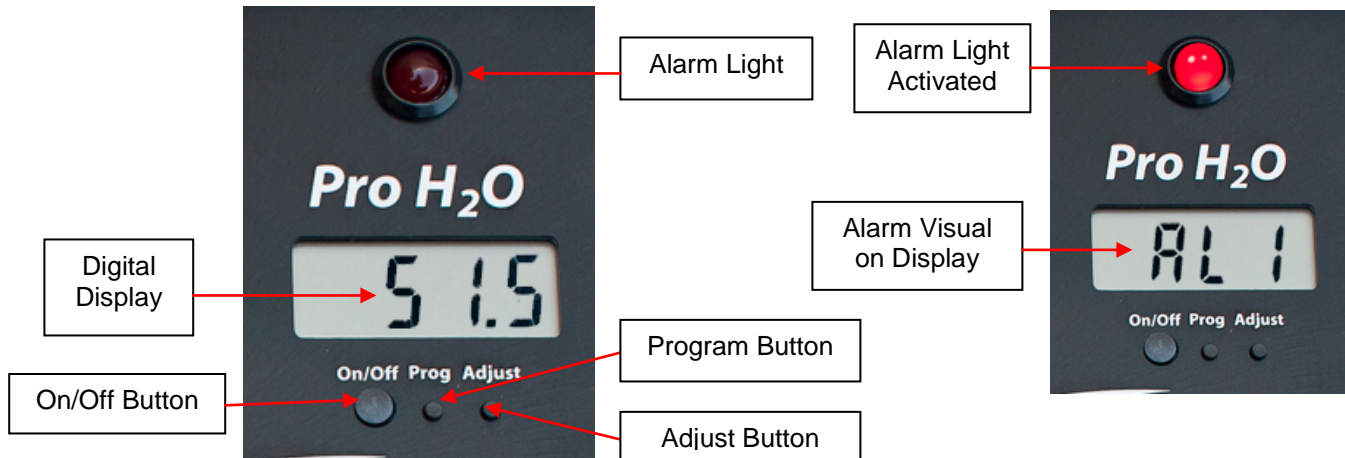

10.2. Pro H₂O Display Readings

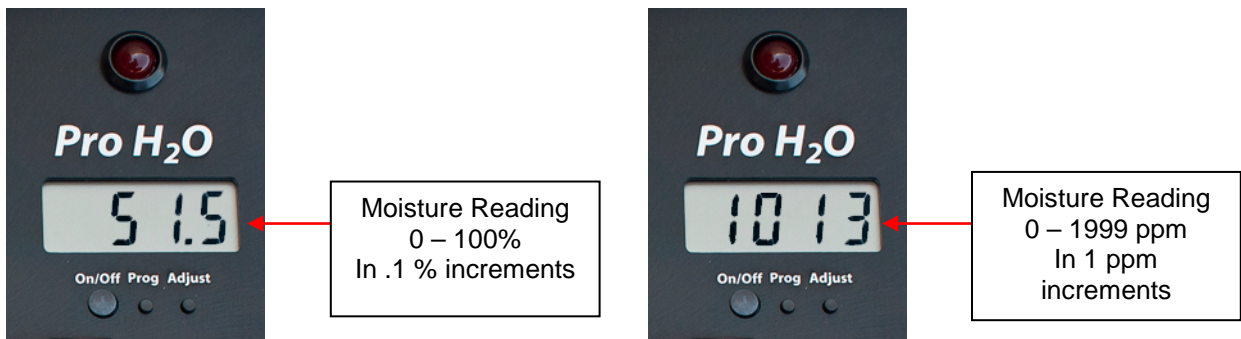

10.3. H₂O Alarm

The Analyzer includes an audible alarm that is activated when the Sensor reaches user programmed level. The alarm will not clear until the concentration of Moisture drops below user programmed level.



! Danger

As soon as the analyzer alarm is tripped shut down your compressor system and replace all of your filter cartridges in the compressor system.

10.4. Pro H₂O Sensor

The Sensor is designed for use at atmospheric pressure (0 P.S.I.). The gas mixture to be analyzed must be regulated accordingly, and any potential for pressure or vacuum must be avoided.

10.5. Pro H₂O Calibration **Warning**

Analyzer calibration must be verified on a daily basis. Improper calibration may result in an incorrect reading, delivering inaccurate levels of moisture being monitored.

 **Warning**

This Analyzer must always be checked with a calibration gas and used with gases regulated and supplied at atmospheric pressure (0 P.S.I.). Use of gases at higher pressures may result in incorrect readings and may damage the Analyzer. Incorrect readings will deliver inaccurate moisture readings.

 **Warning**

Checking Calibration or use of the Analyzer with a low battery may result in inaccurate readings. Inaccurate gas analysis can lead to serious personal injury or death.

 **Notice**

If the Analyzer has been subjected to a recent change in ambient temperature, allow it to stabilize for one hour before checking calibration.

Verify calibration on a daily basis. Breathing gas applications require the use of a certified calibration gas with no moisture concentration and flow rate of 0.5-1 L/min. The equipment to produce this flow is available from Nuvair. See Spares and Accessories section.

To assure the greatest accuracy for other applications, use the calibration gas concentration closest to the expected concentration in the gas being measured.

10.6. Pro H₂O Operation

Prior to each Analyzer use:

- 1) Turn unit on (hold on/off for 3 sec) and monitor Display for low battery warning. Replace battery immediately if warning appears. Once fully cycled the screen should read “000”



- 2) The display will cycle through a couple screens and finish with the current relative humidity percentage of moisture being sensed.
- 3) Cycle through the current alarm settings of the analyzer.
 - a. Hold down the “Prog” button for 2 seconds then use the “On/Off” button to cycle through the 1st Alarm Value, 2nd Alarm Value, Full Scale Value, and Pressure Value. The “End” screen will display for a couple seconds before going back to the current percentage of moisture.
 - b. Adjust Alarm values at this time if needed see “10.8 Programming Procedures”
- 4) Pressing the Adjust key it is displayed the Temperature value (°C) (TeM).
 - 4.1) Pressing again the Adjust key PPM in volume (PPM) is displayed.
 - 4.2) Pressing again the Adjust key Absolute humidity (gr/m³) (AbH) is displayed. The absolute humidity is the mass of water vapor in a particular volume of dry air
 - 4.3) Pressing again the Adjust key Dew Point (°C) (td) is displayed.
 - 4.4) Pressing again the Adjust key Mixing ratio (gr/Kg) (Mr) is displayed. The mixing ratio is the mass of water vapor in a particular mass of dry air.
 - 4.5) Pressing again the Adjust key Volt output of the battery (Bat) is displayed.
 - 4.6) Pressing again the Adjust key zero Offset value (OFS) is displayed. This value is 0 if the analyzer is not adjusted in dry gas. If the instrument was adjusted in 0% RH, OFS is the value of the relative humidity at the zeroing time. During the OFS visualization, pressing at the same time for three seconds ON/OFF and ADJUST key, the instrument will lose the 0 Adjustment, and the OFS value will go to 0.
 - 4.7) Pressing again the Adjust key Relative humidity value is displayed. (Home Screen)
- 5) Check Calibration of Analyzer using “Calibrated Test Gas”

Warning

Gas, even under moderate pressures, can cause extreme bodily harm. Never allow any gas stream to be directed at any part of your body.

Warning

Never expose the sensor to pressures above atmospheric pressure (0 P.S.I.) or you may cause damage to the sensor and/or receive false readings. Damaged Sensors will not provide accurate gas analysis. Inaccurate gas analysis can lead to serious personal injury or death.

⚠ Warning

It is very important that the calibration take place at atmospheric pressure (1 bar) and with calibrated test gas that has no moisture in it.

10.7. Checking Calibration of the Pro H₂O

The Pro H₂O™ can be used to monitor a regulated gas sample flow, the contents of a gas cylinder, or the flow from a regulator:

- 1) Turn on Analyzer with air only flowing through the Pro 4 Warn. Once the analyzer has stabilized you can move on to step 2.
- 2) Turn the Analyzer off.
- 3) Attach a Certified calibration gas that best matches The gas you will be using with the Pro 4 Warn and Open gas line to send a 1 L/min flow to the sensor.
- 4) Turn on the Analyzer and allow reading to stabilize. Record reading and compare to test gas spec.



Once testing is complete and calibration is verified you are able to proceed with using the analyzer.

Nuvair offers gas testing kits see addendum for more information.

Testing Gas must not contain Moisture for calibration to succeed.

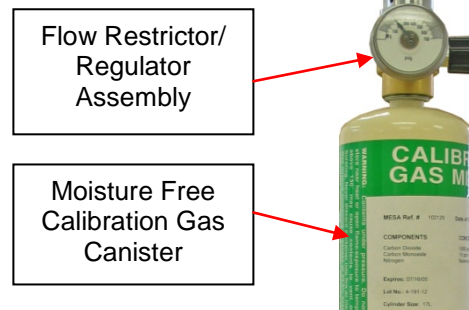

It is possible to calibrate the humidity sensor with a certified dry GAS containing 0% of relative humidity. Attach dry gas to flow inlet of analyser, wait for at least 1 minute and press at the same time ON/OFF and Adjust button. You will see on display CAL Att and the value will be 0, and on the display there will be an up arrow symbol.

⚠ Warning

Calibration gas must be certified Moisture free for accurately calibrating the moisture analyzer.

10.8. Pro H₂O Programming Procedures

Keep the “Pro” button pressed for more than two seconds and then release the button. “Pr” should display for two seconds and then the display will change to AL 1 and alternate with the 3 digit set value.

It is possible to program:

- **AL 1** First alarm point expressed in ppm of Moisture in concentration
- **AL 2** Second alarm point expressed in ppm of Moisture in concentration
- **FSC** Value expressed in ppm of moisture in concentration corresponding to the current output full scale value 4-20mA output if available.
- **PrE** ambient pressure expressed in mBar. Default value is 1013

At the end of the programming procedure the display will show “End” and the instrument will display the moisture in percentage of relative humidity content in the gas.

Below are the actual screen views of each of the modes.



Program



First Alarm



Second Alarm



Full Scale Value



Pressure Value of Sensor



End

10.9. Alarm Setting (AL 1 & AI 2)

- 8.) Press the “Prog” button for more than two seconds and then release the button.
On the display will appear “Pr” for two seconds, then “AL1” will appear and be ready for changing the value of the first alarm point. After a second the display will show the value of “AL1” H₂O ppm current setting. Default is 1999.
- 9.) The blinking digit shows the cursor position.
- 10.) Press the “Prog” button to increase the value (from 0 to 9)
- 11.) Press the “Adjust” button to move the cursor to the next digit, the “Adjust” button will be used to cycle through the rest of the digits.
- 12.) To complete your entry and save the H₂O ppm value, press the “On/Off” button. You will then automatically jump to “AL 2” programming view.
- 13.) Repeat steps 3 through 5 to modify and save the “AL 2” H₂O ppm desired value.
- 14.) Once programming of “AL 2” is complete you will be in the “FSC” Value Screen and ready for programming this value. To jump to the end continue to press the “On/Off” button until the “end” screen appears.

10.10. Full Scale Value Setting (FSC)

Once the alarms have been set the Pro H₂O Analyzer goes to “FSC” view so that you can change the analog full scale value. The FSC value sets the span of the instrument for the 4-20 mA output, if available. The value is related to PPM value.

It is not necessary to modify this value which is factory set. This value can be changed in the same manner as the Alarm settings:

- 6.) Press the “Prog” button for more than two seconds and then release the button.
On the display will appear “Pr” for two seconds, then “AL 1” will appear. Press the On/Off button to cycle through the Alarm settings until you reach the “FSC” view. The “FSC” screen and a 3 digit value will alternate for a few seconds and the Pro CO Analyzer will be ready for adjusting the “FSC” Value.
- 7.) The blinking digit shows the cursor position.
- 8.) Press the “Prog” button to increase the value (from 0 to 9)
- 9.) Press the “Adjust” button to move the cursor to the next digit, the “Adjust” button will be used to cycle through the rest of the digits.
- 10.) To complete your entry and save the FSC value, press the “On/Off” button. You will then automatically jump to “PrE” programming view. To continue pass this to the end press the On/Off button until the “End” screen appears.

10.11. Ambient Pressure Value (PrE)

After the “FSC” is set the Pro H₂O Analyzer goes to “PrE”, this is the Ambient Pressure value, measured in mBar. Default is 1013 It is not necessary to modify this value. The display will have a blinking digit which shows the current cursor position.

- 5.) Press the “Prog” button for more than two seconds and then release the button.
On the display will appear “Pr” for two seconds, then “AL 1” will appear. Use the On/Off button to cycle through the various settings until you reach the PrE” screen. The 4th digit value will blink and is the first value that can be changed.
- 6.) The blinking digit shows the cursor position.
- 7.) Press the “Prog” button to increase the value (from 0 to 9)
- 8.) Press the “Adjust” button to move the cursor to the next digit, the “Adjust” button will be used to cycle through the rest of the digits.
- 9.) To complete your entry and save the PrE value, press the “On/Off” button. You will then automatically jump to “End” programming view.



! Danger

As soon as the analyzer alarm is tripped shut down your compressor system and replace all of your filter cartridges in the compressor system.

10.12. Pro H₂O Threshold Alarms

Should the Moisture content go over the threshold alarms (AL1 or AL2) set in the analyzer visual and audible alarms will be activated and any optional relay outputs (open collector max 100mA) will be activated. The display will show the trespassed alarm and actual measured value. To stop the audible alarm, press any key. The Pro H₂O Analyzer will remain in alarm mode until the analyzed value goes below the alarm set point. The relay output typically is used to shut down the compressor or activate external optional alarms. NuVair can supply the necessary components to adapt your compressor to the relay or provide them at the time of install on a new compressor.

10.13. Pro H₂O Powering Off

At the home or gas reading screen, hold down the On/Off button for a couple of seconds. The Analyzer will display "OFF" and then go blank.



10.14. Pro H₂O Factory Reset

In case it is necessary to reset the Pro H₂O Analyzer to the factory settings, power on the Analyzer pressing at the same time for more than one second the "On/Off" and "Adjust" buttons. On the display will appear "res" and the instrument will go to the reading page.

! Warning

Resetting the Analyzer will result in all user programmed alarms and calibration being erased and set at factory defaults.

11.0 Pro CO₂ Carbon Dioxide Analyzer

The Pro CO₂ Carbon Dioxide Analyzer measures Carbon Dioxide (CO₂) levels in gases in the range of 0 to 2000 parts per million (ppm). It can be used to measure the CO₂ content in all breathing gas mixes. The Analyzer is designed to verify CO₂ concentration in stored gas cylinders as well as to monitor continuous flow of sample gas from a compressor.



! Danger

Carbon Dioxide is a colorless, odorless, tasteless gas that will not support life. Exposure to Carbon Dioxide can lead to unconsciousness and death.

Pro 4 Warn Analyzer

The Analyzer includes an internally mounted Sensor with audible and visual alarms. Large Digital Display and controls are environmentally sealed.

The Analyzer uses regulated flow within the analyzer to deliver sample gas to the sensor. Pressurized gases must be regulated to avoid damage to the analyzer. Use of this Analyzer in a hyperbaric chamber will void the owner's warranty.

The Analyzer comes in a high impact storage case. It is ready for use after calibration with an appropriate certified calibration gas.

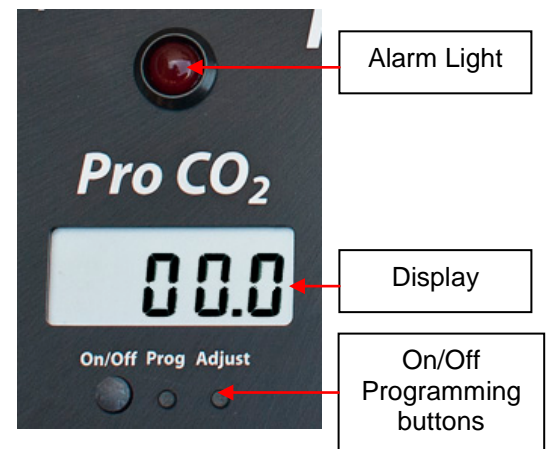

Warning

This analyzer is designed for use at atmospheric pressures only. It is not designed for exposures in a hyperbaric chamber. Use of this analyzer in a hyperbaric chamber will result in incorrect readings and may damage the unit.

Warning

Although the Analyzer is a rugged instrument, careless handling or abuse may result in damage to the Analyzer resulting in inaccurate gas analysis. Inaccurate gas analysis can lead to serious personal injury or death.

Notice

High gas flow directed at the CO2 Analyzer sensor may damage the sensor.

11.1. Pro CO₂ Controls

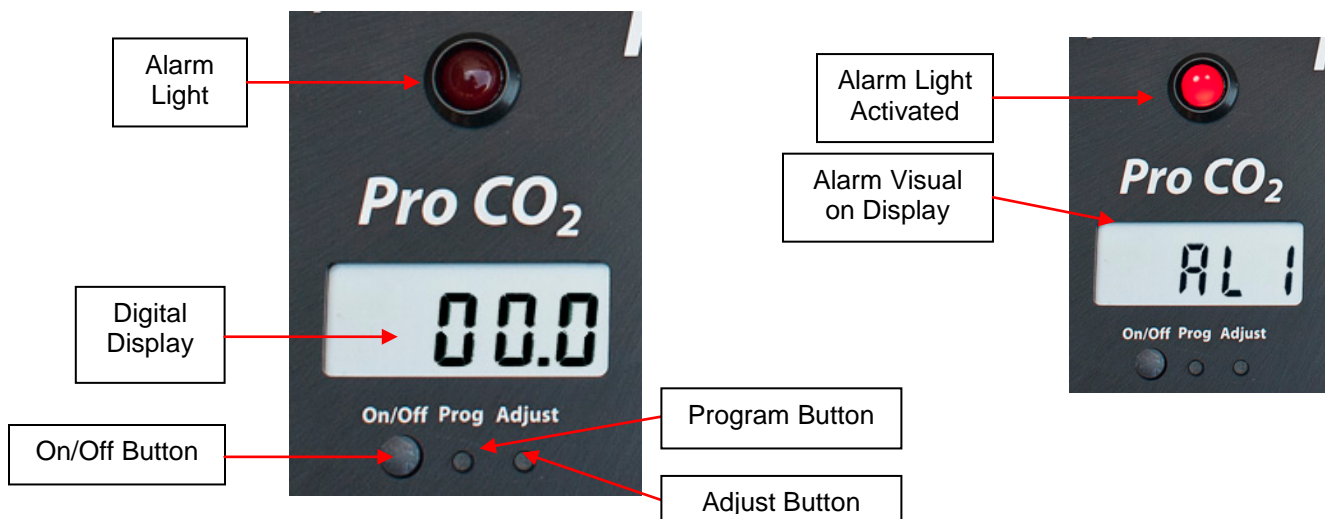

11.2. Pro CO₂ Display

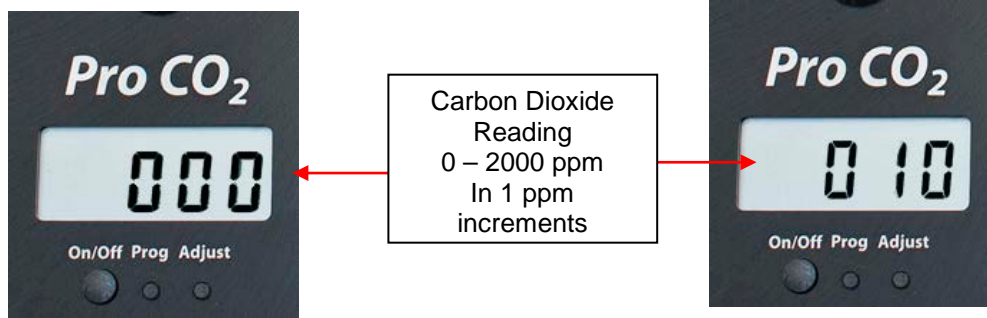

11.3. Pro CO₂ Alarm

The Analyzer includes an audible alarm that is activated when the Sensor reaches 199 ppm CO₂ or user programmed level. The alarm will not clear until the concentration of CO₂ drops below user programmed level.

11.4. Pro CO₂ Sensor

The Analyzer uses an NDIR “non-dispersive infra red” CO₂ Sensor to measure CO₂ content in gases. The Sensor is disposable and user-replaceable, with a life expectancy of up to 24 months depending on usage. The Sensor is designed for use at atmospheric pressure (0 P.S.I.). The gas mixture to be analyzed must be regulated accordingly, and any potential for pressure or vacuum must be avoided.

11.5. Pro CO₂ Calibration

Warning

Analyzer calibration must be verified on a weekly basis or when moisture and or temperature swings take place. Improper calibration may result in an incorrect reading, exposing the user to dangerous levels of Carbon Dioxide. Exposure to Carbon Dioxide can lead to unconsciousness and death.

Warning

This Analyzer must always be checked against a calibration gas and used with gases regulated and supplied at atmospheric pressure (0 P.S.I.). Use of gases at higher pressures may result in incorrect readings and may damage the Analyzer. Incorrect readings may expose the user to high levels of Carbon Dioxide resulting in personal injury or death.

Warning

Checking Calibration or use of the Analyzer with a low battery may result in inaccurate readings. Inaccurate gas analysis can lead to serious personal injury or death.

Notice

If the Analyzer has been subjected to a recent change in ambient temperature, allow it to stabilize for one hour before checking calibration.

Verify calibration on a weekly basis or when the ambient temperature or moisture changes dramatically. Breathing gas applications require the use of a certified CO₂ calibration gas and flow rate of 0.5-1 L/min. The equipment to produce this flow is available from Nuvair. See Spares and Accessories section.

To assure the greatest accuracy for other applications, use the calibration gas concentration closest to the expected concentration in the gas being measured.

11.6. Pro CO₂ Operation

Prior to each Analyzer use:

Turn unit on (hold on/off for 3 sec) and monitor Display for low battery warning. Replace battery immediately if warning appears. The display will count down from 29 PPM to Att and then display the current CO₂ level sensed by the analyzer sensor.



Cycle through the current settings of the analyzer:

- c. Hold down the “Prog” button for 2 seconds then use the “On/Off” button to cycle through the low Alarm Value, high Alarm Value, Full Scale Value and end.
- d. Adjust Alarm values at this time if needed see “11.9. Pro CO₂ Alarm Settings”

Check Calibration of Analyzer using “Calibrated Test Gas”

Tip: You can check the battery life and current temperature by holding Adjust button for 3 seconds. The display will alternate from battery life to current temperature (Celsius) twice before returning the home screen.



Warning

Do not test cylinders suspected of containing carbon dioxide in a confined space that does not have good ventilation. Exposure to carbon dioxide can lead to unconsciousness and death.

Warning

Gas, even under moderate pressures, can cause extreme bodily harm. Never allow any gas stream to be directed at any part of your body.

⚠ Warning

Never expose the sensor to pressures above atmospheric pressure (0 P.S.I.) or you may cause damage to the sensor and/or receive false readings. Damaged Sensors will not provide accurate gas analysis. Inaccurate gas analysis can lead to serious personal injury or death.

The Pro CO₂TM can be used to monitor an enclosed space or to analyze a regulated gas sample flow, the contents of a gas cylinder, or the flow from a regulator:

- If monitoring an enclosed space, simply remove the Flow Adapter Cap to expose the Sensor face to the atmosphere and allow 15 seconds for the Display reading to stabilize.
- If analyzing a gas flow, the Sample Flow Method is the preferred method. The flow rate must equal 0.5 to 1 L/min at atmospheric pressure (1 bar). To produce this flow, a Flow Restrictor and Regulator may be required. Contact Nuair if you need assistance.

11.7. Pro CO₂ Sample Flow Method of Checking Calibration (Preferred)

- 1) Turn on Analyzer with air only flowing through the Pro 4 Warn. Once the analyzer has stabilized you can move on to step 2.
- 2) Turn the Analyzer off.
- 3) Attach a Certified calibration gas that best matches The gas you will be using with the Pro 4 Warn and Open gas line to send a 1 L/min flow to the sensor.
- 4) Turn on the Analyzer and allow reading to stabilize. Record reading and compare to test gas spec.



Once testing is complete and calibration is verified you are able to proceed with using the analyzer.

Nuair offers CO₂ gas testing kits see addendum for more information.

Testing Gas must not contain Helium for calibration to succeed.

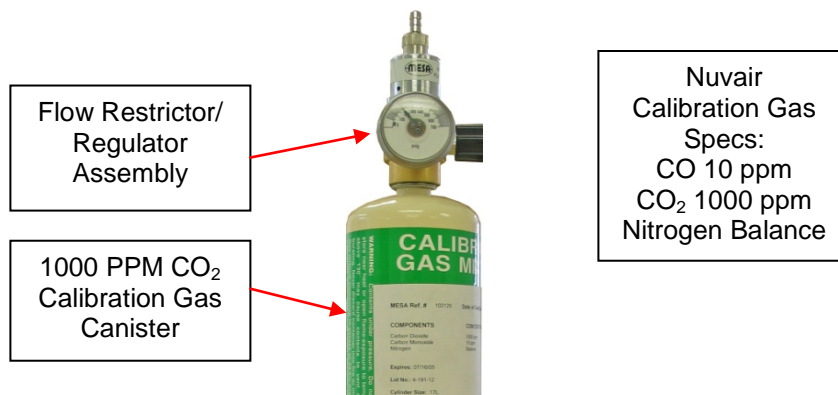

11.8. Pro CO₂ Programming Procedures

Keep the “Prog” button pressed for more than two seconds and then release the button. “Pr” should display for two seconds and then the display will change to AL 1 and alternate with the 3 digit set value.

It is possible to program:

- **AL 1** Low alarm point expressed in ppm of Carbon Dioxide concentration
- **AL 2** High alarm point expressed in ppm of Carbon Dioxide concentration
- **FSC** Value expressed in ppm of Carbon Dioxide concentration corresponding to the current output full scale value (20mA). 4mA always correspond to 1999 ppm CO₂ concentration.

At the end of the programming procedure the display will show “End” and the instrument will display the Carbon Dioxide content in the gas mix.

Below are the actual screen views of each of the modes. (*Calib button say as adjust)



Program



Low Alarm



High Alarm



Full Scale Value



End

11.9. Pro CO₂ Alarm Setting (AL 1 & AL 2)

- 1.) Press the “Prog” button for more than two seconds and then release the button.
On the display will appear “Pr” for two seconds, then “AL1” will appear and be ready for changing the value of the low alarm point. After a second the display will show the value of “AL1” CO₂ ppm current setting.
- 2.) The blinking digit shows the cursor position.
- 3.) Press the “Prog” button to increase the value (from 0 to 9)
- 4.) Press the “Adjust” button to move the cursor to the next digit, the “Adjust” button will be used to cycle through the rest of the digits.
- 5.) To complete your entry and save the CO₂ ppm value, press the “On/Off” button. You will then automatically jump to “AL 2” programming view.
- 6.) Repeat steps 3 through 5 to modify and save the “AL 2” high alarm CO₂ ppm desired value.
- 7.) Once programming of “AL 2” is complete you will be in the “FSC” Value Screen and ready for programming this value. To jump to the end continue to press the “On/Off” button until the end screen appears.

11.10. Pro CO₂ Full Scale Value Setting (FSC)

Once the alarms have been set the Pro CO₂ Analyzer goes to “FSC” view so that you can change the analog full scale value. It is not necessary to modify this value which is factory set at 1999. However if installing a new sensor the value on the sensor can be entered into the “Fsc” setting and must be entered into the “Fct” setting. This is the Carbon Dioxide concentration corresponding to 20 mA on the analog output. 4mA is the value at 1999 ppm of Carbon Dioxide. This value can be changed in the same manner as the Alarm settings:

- 1.) Press the “Prog” button for more than two seconds and then release the button.
On the display will appear “Pr” for two seconds, then “AL 1” will appear. Press the On/Off button to cycle through the Alarm settings until you reach the “FSC” view. The “FSC” screen and a 3 digit value will alternate for a few seconds and the Pro CO₂ Analyzer will be ready for adjusting the “FSC” Value.
- 2.) The blinking digit shows the cursor position.
- 3.) Press the “Prog” button to increase the value (from 0 to 9) (0-19 on the third value)
- 4.) Press the “Adjust” button to move the cursor to the next digit, the “Adjust” button will be used to cycle through the rest of the digits.
- 5.) To complete your entry and save the FSC value, press the “On/Off” button. You will then automatically jump to “End” programming view.

11.11. Pro CO₂ Threshold Alarms

The CO₂ analyzer will alarm until it has reached the AL1 (low) set point if the AL1 has been set. Once the gas is above the AL1 set point the analyzer will not alarm until the gas value is over AL2 or under AL1 during the gas analyzation. Should the Carbon Dioxide gas trip the low or high alarms (AL1 or AL2) the instrument will go into alarm mode and will activate the (optional) relays output (open collector max 100mA) and the internal buzzer. The display will show the trespassed alarm and the actual measured value. To stop the audible alarm, press any key. In this event the Pro CO₂ Analyzer will remain in alarm mode until the analyzed value reads between the AL1 and AL2 set points. The relay output typically is used to shut down the compressor. Nuvair can supply the necessary components to adapt your compressor to the relay or provide them at the time of install on a new compressor.

11.12. Pro CO₂ Powering Off

At the home or gas reading screen, hold down the On/Off button for a couple of seconds. The Analyzer will display “OFF” and then go blank.



11.13. Pro CO₂ Factory Reset

In case it is necessary to reset the Pro CO₂ Analyzer to the factory settings, power on the Analyzer pressing at the same time for more than one second the “On/Off” and “Adjust” buttons. On the display will appear “res” and the instrument will go to the reading page.

Warning

In case of reset, the instrument will delete all the alarms settings and the full scale value. Before using again the instrument, it may be necessary to program again the alarm values and the full scale value. All the analysis concentration shown on the display could be wrong. Wrong Carbon Dioxide analysis may lead to death. You should calibrate your analyzer immediately after a reset before using.

11.14. Pro CO₂ Sensor Replacement

Take care not to damage sensor when replacing.

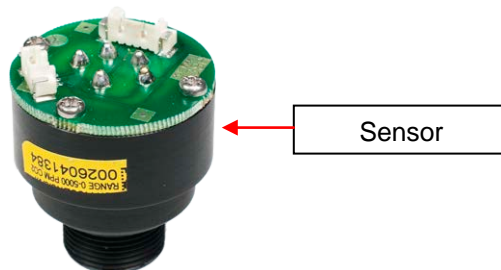

11.15. Handling Sensors

Replacement Sensors are supplied in sealed bags. Normally Sensors do not present a health hazard. Dispose of Sensor properly or return for replacement. These sensors are made using solid state technology and should be disposed of according to local regulations for electronic parts.

12.0 Pro CO Carbon Monoxide Analyzer

The Pro CO™ Carbon Monoxide Analyzer measures carbon monoxide (CO) levels in gases in the range of 0 to 100 parts per million (ppm). It can be used to measure the CO content in gas mixes that may be contaminated due to the introduction of CO from internal combustion engines or other devices where CO is a byproduct. The Analyzer is designed to verify CO concentration in stored gas cylinders as well as gas flow from a compressor.



Danger

Carbon monoxide is a colorless, odorless, tasteless gas that will not support life. Exposure to carbon monoxide can lead to unconsciousness and death.

The Analyzer includes an internally mounted Sensor with audible and visual alarms. Large Digital Display and controls are environmentally sealed.

The Analyzer uses regulated flow within the analyzer to deliver sample gas to the sensor. Pressurized gases must be regulated to avoid damage to the analyzer. Use of this Analyzer in a hyperbaric chamber will void the owner's warranty.

The Analyzer comes in a high impact storage case. It is ready for use after calibration with an appropriate certified calibration gas.

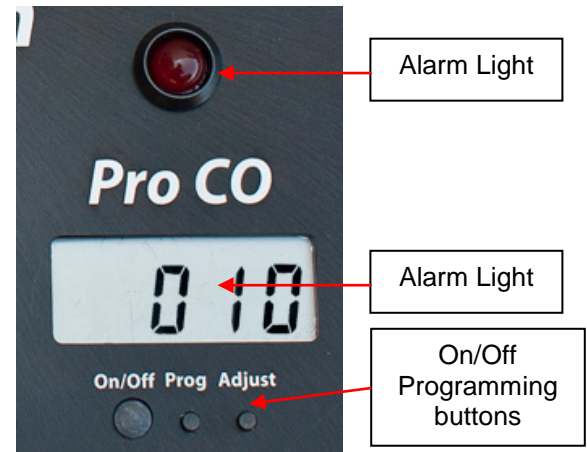

Warning

This analyzer is designed for use at atmospheric pressures only. It is not designed for exposures in a hyperbaric chamber. Use of this analyzer in a hyperbaric chamber will result in incorrect readings and may damage the unit.

Warning

Although the Analyzer is a rugged instrument, careless handling or abuse may result in damage to the Analyzer resulting in inaccurate gas analysis. Inaccurate gas analysis can lead to serious personal injury or death.

Notice

Extreme CO exposure levels directed at the Analyzer sensor may damage the sensor. Don't test the sensor in the direct flow of any engine mufflers/exhausts or any other known high concentrations of CO₂.

12.1. Pro CO Analyzer Controls

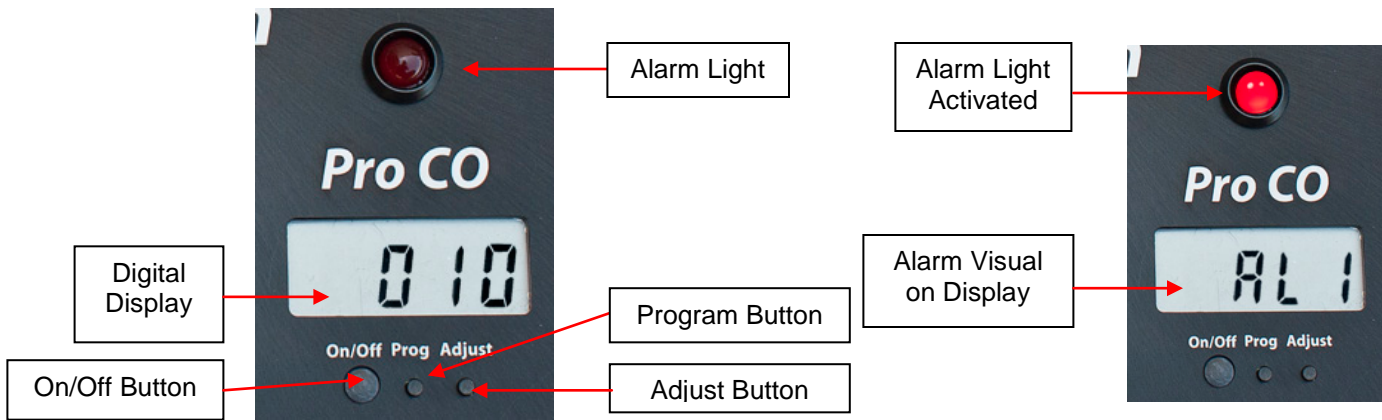

12.2. Pro CO Display

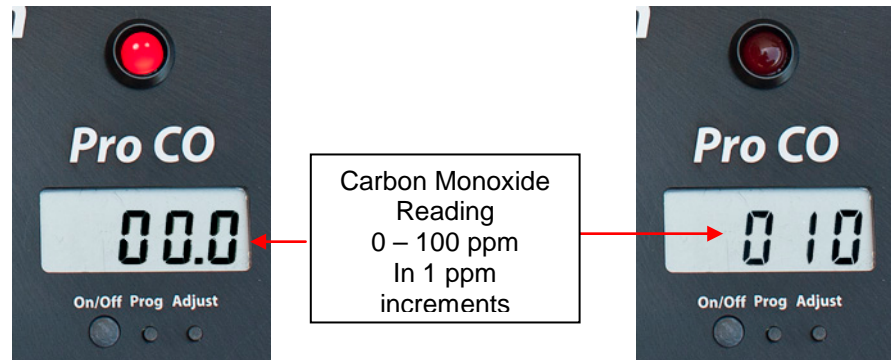

12.3. Pro CO Alarm

The Analyzer includes an audible alarm that is activated when the Sensor reaches 10 ppm CO or user programmed level. The alarm will not clear until the concentration of CO drops below 10 ppm or user programmed level.

12.4. Pro CO Sensor

The Analyzer uses an electrochemical CO Sensor to measure CO content in gases. The Sensor is disposable and user-replaceable, with a life expectancy of up to 24 months depending on usage. The Sensor is designed for use at atmospheric pressure (0 P.S.I.). The gas mixture to be analyzed must be regulated accordingly, and any potential for pressure or vacuum must be avoided.

12.5. Pro CO Calibration

Verify calibration on a weekly basis or when the ambient temperature or moisture changes dramatically. Breathing gas applications require the use of a certified CO calibration gas and flow rate of 0.5-1 L/min. The equipment to produce this flow is available from Nuair. See Spares and Accessories section.

To assure the greatest accuracy for other applications, use the calibration gas concentration closest to the expected concentration in the gas being measured.

⚠ Warning

Analyzer calibration must be verified on a weekly basis. Improper calibration may result in an incorrect reading, exposing the user to dangerous levels of carbon monoxide. Exposure to carbon monoxide can lead to unconsciousness and death.

⚠ Warning

This Analyzer must always be checked against a calibration gas and used with gases regulated and supplied at atmospheric pressure (0 P.S.I.). Use of gases at higher pressures may result in incorrect readings and may damage the Analyzer. Incorrect readings may expose the user to high levels of carbon monoxide resulting in personal injury or death.

⚠ Warning

Checking Calibration or use of the Analyzer with a low battery may result in inaccurate readings. Inaccurate gas analysis can lead to serious personal injury or death.

⚠ Notice

If the Analyzer has been subjected to a recent change in ambient temperature, allow it to stabilize for one hour before checking calibration.

Verify calibration on a weekly basis. Breathing gas applications require the use of a certified CO calibration gas with a 10 ppm concentration and flow rate of 0.5-1 L/min. The equipment to produce this flow is available from NuVair. See Spares and Accessories section.

To assure the greatest accuracy for other applications, use the calibration gas concentration closest to the expected concentration in the gas being measured.

12.6. Pro CO Operation

Prior to each Analyzer use:

- 1) Turn unit on (hold on/off for 3 sec) and monitor Display for low battery warning. Replace battery immediately if warning appears. Once fully cycled the screen should read "000"



- 2) Cycle through the current settings of the analyzer.
 - a. Hold down the "Prog" button for 2 seconds then use the "On/Off" button to cycle through the 1st Alarm Value, 2nd Alarm Value, Full Scale Value, Conversion Value of the Sensor, and Gain Factor.
 - b. Adjust Alarm values at this time if needed see "12.9. Pro CO Alarm Settings".
- 3) Check Calibration of Analyzer using "Calibrated Test Gas"

Tip: You can check the battery life and current temperature by holding Adjust button for 3 seconds. The display will alternate from battery life to current temperature (Celsius) twice before returning the home screen.



Warning

Do not test cylinders suspected of containing carbon monoxide in a confined space that does not have good ventilation. Exposure to carbon monoxide can lead to unconsciousness and death.

Warning

Gas, even under moderate pressures, can cause extreme bodily harm. Never allow any gas stream to be directed at any part of your body.

Warning

Never expose the sensor to pressures above atmospheric pressure (0 P.S.I.) or you may cause damage to the sensor and/or receive false readings. Damaged Sensors will not provide accurate gas analysis. Inaccurate gas analysis can lead to serious personal injury or death.

Warning

It is very important that the calibration take place at atmospheric pressure (1 bar) and roughly 68° F (20° C) with the surrounding air being clean of CO. Calibration performed in air with CO such as aboard a moving boat with diesel exhaust or construction site with diesel engines operating will affect the calibration. On a moving boat air flow can trap the engine exhaust in the cabin or open deck area creating a high CO environment that will affect calibration.

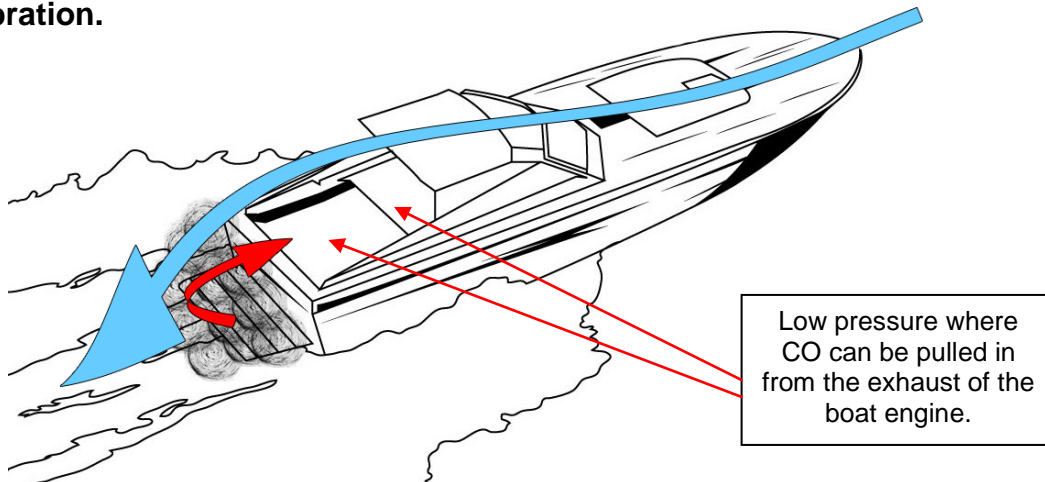

The Pro CO™ can be used to analyze a regulated gas sample flow, the contents of a gas cylinder, or the flow from a regulator:

- If analyzing a gas flow, the Sample Flow Method is the preferred method. The flow rate must equal 0.5 to 1 L/min at atmospheric pressure (1 bar). To produce this flow, a Flow Restrictor and Regulator may be required. Contact Nuair if you need assistance.

12.7. Pro CO Sample Flow Method of Checking Calibration

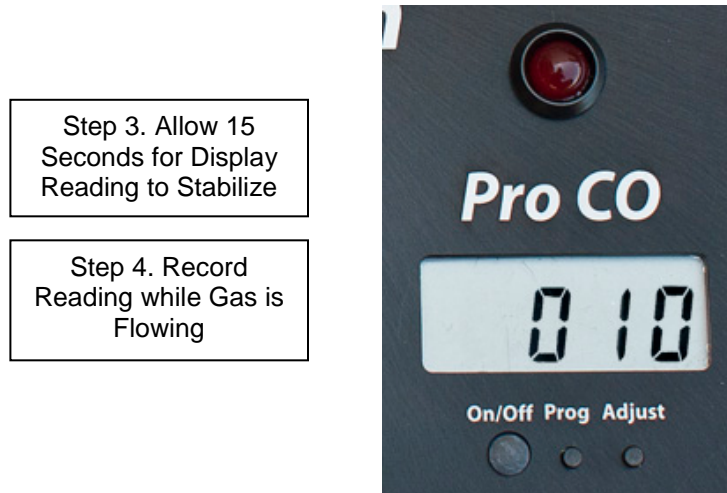

Nuair offers CO gas testing kits see addendum for more information.
Testing Gas must not contain Helium for calibration to succeed.

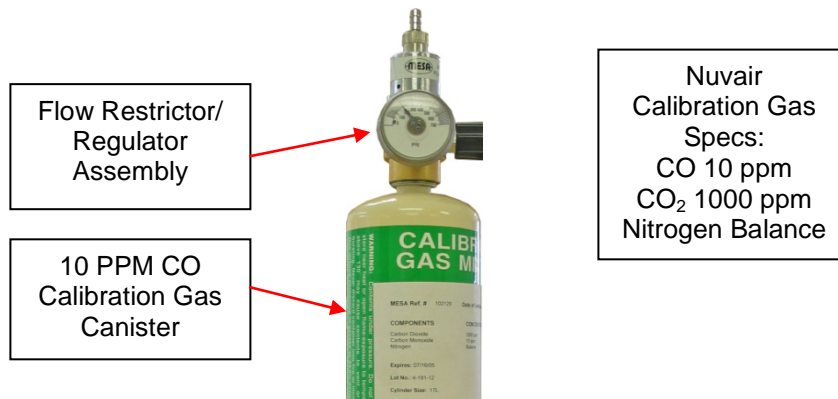

12.8. Pro CO Programming Procedures

Keep the “Pro” button pressed for more than two seconds and then release the button. “Pr” should display for two seconds and then the display will change to AL 1 and alternate with the 3 digit set value.

It is possible to program:

- **AL 1** First alarm point expressed in ppm of Carbon Monoxide concentration
- **AL 2** Second alarm point expressed in ppm of Carbon Monoxide concentration
- **FSC** Value expressed in ppm of Carbon Monoxide concentration corresponding to the current output full scale value (20mA). 4mA always correspond to zero ppm CO concentration.
- **nA** Conversion value of Carbon Monoxide sensor
- **Fct** Gain factor

At the end of the programming procedure the display will show “End” and the instrument will display the Carbon Monoxide content in the gas mix or “000” if not attached to a CO gas mix.

Below are the actual screen views of each of the modes.



Program



First Alarm



Second Alarm



Full Scale Value



Conversion Value of Sensor



Gain Factor

12.9. Pro CO Alarm Setting (AL 1 & AI 2)

- 1.) Press the “Prog” button for more than two seconds and then release the button.
On the display will appear “Pr” for two seconds, then “AL1” will appear and be ready for changing the value of the first alarm point. After a second the display will show the value of “AL1” CO ppm current setting.
- 2.) The blinking digit shows the cursor position.
- 3.) Press the “Prog” button to increase the value (from 0 to 9)
- 4.) Press the “Adjust” button to move the cursor to the next digit, the “Adjust” button will be used to cycle through the rest of the digits.
- 5.) To complete your entry and save the CO ppm value, press the “On/Off” button. You will then automatically jump to “AL 2” programming view.
- 6.) Repeat steps 3 through 5 to modify and save the “AL 2” CO ppm desired value.
- 7.) Once programming of “AL 2” is complete you will be in the “FSC” Value Screen and ready for programming this value. To jump to the end continue to press the “On/Off” button until the end screen appears.

12.10. Full Scale Value Setting (FSC)

Once the alarms have been set the Pro CO Analyzer goes to “FSC” view so that you can change the analog full scale value. It is not necessary to modify this value which is factory set at 300. However if installing a new sensor the value on the sensor can be entered into the “Fsc” setting and must be entered into the “Fct” setting. This is the Carbon Monoxide concentration corresponding to 20 mA on the analog output. 4mA is the value at 0 ppm of Carbon Monoxide. This value can be changed in the same manner as the Alarm settings:

- 1.) Press the “Prog” button for more than two seconds and then release the button.
On the display will appear “Pr” for two seconds, then “AL 1” will appear. Press the On/Off button to cycle through the Alarm settings until you reach the “FSC” view. The “FSC” screen and a 3 digit value will alternate for a few seconds and the Pro CO Analyzer will be ready for adjusting the “FSC” Value.
- 2.) The blinking digit shows the cursor position.
- 3.) Press the “Prog” button to increase the value (from 0 to 9)
- 4.) Press the “Adjust” button to move the cursor to the next digit, the “Adjust” button will be used to cycle through the rest of the digits.
- 5.) To complete your entry and save the FSC value, press the “On/Off” button. You will then automatically jump to “nA” programming view. To continue pass this to the end press the On/Off button until the “End” screen appears.

12.11. Conversion Value of Carbon Monoxide Sensor (nA)

After the “FSC” is set the Pro CO Analyzer goes to “nA”, this is the conversion value of the Carbon Monoxide sensor in nano Ampere. It is not necessary to modify this value except when a new sensor is installed. The new sensor is provided with the new value to be set on this screen. The display alternates between “nA” and the value of the full scale. The blinking digit shows the current cursor position.

- 1.) Press the “Prog” button for more than two seconds and then release the button.
On the display will appear “Pr” for two seconds, then “AL 1” will appear. Use the On/Off button to cycle through the various settings until you reach the nA” screen. The 3 digit value will alternate with the “nA” screen for a few seconds and the Pro CO Analyzer will be ready for adjusting the “nA” Value.
- 2.) The blinking digit shows the cursor position.
- 3.) Press the “Prog” button to increase the value (from 0 to 9)
- 4.) Press the “Adjust” button to move the cursor to the next digit, the “Adjust” button will be used to cycle through the rest of the digits.

5.) To complete your entry and save the Na value, press the “On/Off” button. You will then automatically jump to “Fct” programming view. To continue pass this to the end press the On/Off button until the “End” screen appears.

6.) This procedure is used ONLY when a new sensor has been ordered from Nuvair and is ready to be installed.

Warning

The conversion value of the Carbon Monoxide sensor is set in factory and must be changed only when the CO sensor is replaced. The new sensor will come from the factory with a label showing the new “nA” value to be programmed. A wrong value of this parameter will give a wrong reading of CO concentration. If it is modified the conversion value of the Carbon Monoxide sensor, the instrument will be no more accurate. All the analysis concentration shown on the display will be wrong. Do not modify this value. It is necessary to modify this value only at the installation of a new sensor. Wrong Carbon Monoxide analysis may lead to death.

12.12. Gain Factor (Fct)

After the “nA” the instrument goes to “Fct”, that is the conversion value of gain factor. It is not necessary to modify this value except when a new sensor is installed. The new sensor is provided with the new value to be set on this screen. The value is referred to as the “Fsc” number on the sensor. The display alternates between “Fct” and the conversion value of the gain factor.

The blinking digit shows the current cursor position.

- 1.) Press the “Prog” button for more than two seconds and then release the button. On the display will appear “Pr” for two seconds, then “AL 1” will appear. Use the On/Off button to cycle through the various settings until you reach the “Fct” screen. The 3 digit value will alternate with the “Fct” screen for a few seconds and the Pro CO Analyzer will be ready for adjusting the “Fct” Value.
- 2.) The blinking digit shows the cursor position.
- 3.) Press the “Prog” button to increase the value (from 0 to 9)
- 4.) Press the “Adjust” button to move the cursor to the next digit, the “Adjust” button will be used to cycle through the rest of the digits.
- 5.) To complete your entry and save the Gain Factor value, press the “On/Off” button. You will then automatically jump to the “End” and return to the current gas reading.
- 6.) This procedure is used ONLY when a new sensor has been ordered from Nuvair and is ready to be installed.**

Warning

Then gain factor is set in factory and must be changed only when the CO sensor is replaced. The new sensor will come from the factory with a label showing the new ‘Fct’ value to be programmed. A wrong value of this parameter will give a wrong reading of CO concentration. If it is modified the gain factor instrument will be no more accurate. All the analysis concentration shown on the display will be wrong. Do not modify this value. It is necessary to modify this value only at the installation of a new sensor. Wrong Carbon Monoxide analysis may lead to death.

12.13. Pro CO Threshold Alarms

Should the Carbon Monoxide reading go over the threshold alarms (AL1 or AL2) the instrument will go into alarm mode and will activate the (optional) relays output (open collector max 100mA) and the internal buzzer. The display will show the trespassed alarm and the actual measured value. To stop the audible alarm, press any key. In this event the Pro Co Analyzer will remain in alarm mode until the analyzed value goes below the alarm. The relay output typically is used to shut down the compressor. NuVair can supply the necessary components to adapt your compressor to the relay or provide them at the time of install on a new compressor.

12.14. Powering Off the Pro CO

At the home or gas reading screen, hold down the On/Off button for a couple of seconds. The Analyzer will display "OFF" and then go blank.



12.15. Pro CO Factory Reset

In case it is necessary to reset the Pro CO Analyzer to the factory settings, power on the Analyzer pressing at the same time for more than one second the "On/Off" and "Adjust" buttons. On the display will appear "res" and the instrument will go to the reading page.

You will need to open the Pro CO analyzer and get the Values from the sensor for inputting into the PRO CO analyzer before using.

⚠ Warning

In case of reset, the instrument will delete all the alarms settings, the full scale value, any new conversion value of Carbon Monoxide sensor and of the gain factory. Before using again the instrument, it may be necessary to program again the alarm values, the full scale value, and the conversion value of Carbon Monoxide sensor and gain factor if changed. All the analysis concentration shown on the display would be wrong. Wrong Carbon Monoxide analysis may lead to death.

12.16. Pro CO Sensor Replacement

You should take note of your "Fsc" Number and "nA" Number before installing a new sensor. The "Fsc" number is programmed into the Pro CO Analyzer at the "Fct" and "Fsc" setting. This information will be used to program the Pro CO analyzer after the sensor is installed.



⚠ Caution

Be sure to dispose of spent, leaking, or damaged Sensors properly, according to local regulations.

⚠ Danger

Do not swallow (ingest) either the electrolyte from the Sensor or the Sensor itself. The Potassium hydroxide chemical contained in the Sensor will cause severe injury or death. If electrolyte or the Sensor is swallowed, seek medical attention immediately.



⚠ Warning

If after handling the Analyzer or Sensor, you find that your fingers or other parts of your body feel “slippery” or the skin or eyes sting, immediately flush affected area with clean, fresh water for at least 15 minutes. The stinging or slippery sensation is an indication of a leaking Sensor. The Potassium Hydroxide chemical contained in the Sensor can cause severe injury or death. Seek immediate medical attention if eye contact is made or skin stinging persists.

12.17. Handling Pro CO Sensors

Replacement Sensors are supplied in sealed bags. Normally Sensors do not present a health hazard. Before opening the bag, check that the electrolyte has not leaked. However, if electrolyte leakage has occurred, do not open bag. Dispose of Sensor properly or return for replacement. If electrolyte leakage occurs while the Sensor is in service, use rubber gloves and chemical splash goggles for handling. Rinse contaminated surfaces thoroughly with water.

Electrolyte First Aid Procedures

- Ingestion - Drink a large volume of fresh water. Do not induce vomiting. Get immediate medical attention.
- Eye Contact - Flush eyes with clean, fresh water for at least 15 minutes and get medical help immediately.
- Skin Contact - Flush the affected area with clean, fresh water for at least 15 minutes and removed contaminated clothing. If stinging persists get medical attention.

13.0 Spares and Accessories

13.1. Calibration Equipment

Calibration requires certified calibration gas to be free of any moisture and delivered at a specific flow rate and pressure.

Nuvair offers a calibration gas canister with a compatible flow restrictor and regulator assembly to regulate the gas for proper calibration.

Flow Restrictor/
Regulator
Assembly

Nuvair
Calibration Gas
Specs:
CO 10 ppm
CO₂ 1000 ppm
Nitrogen Balance



14.0 Troubleshooting

SYMPTOM	REASON	SOLUTION
Battery symbol	Low Battery	Change the battery
No display	Switched off	Switch on
	Bad connection	Check display/ battery connection
	Low Battery	Change the battery
Reading erratic	Pressure on sensor	Check flow
	Radio transmission	Move unit away
	Sensor old or faulty	Change sensor
	Condensation on sensor.	Dry in air
Display segments missing	Display faulty	Return to dealer
Reading drifts	Rapid temperature change	Stabilize temperature & recalibrate

15.0 Relay Output Schematics

4-20mA Connections: The relay output uses a special “Mini Jack” plug that can be purchased separately from NuVair. Insert the plug into the output jack. Connections diagram below for additional wiring.

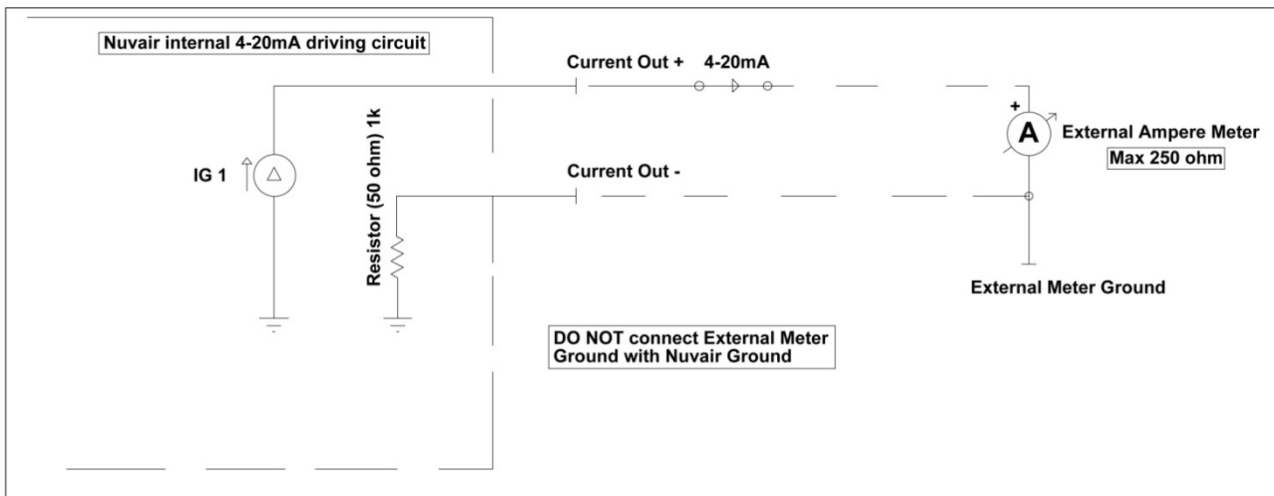

Warning

The plug should be connected or disconnected when the instrument is switched off, or the instrument will automatically switch off.

Open Collector Connections:

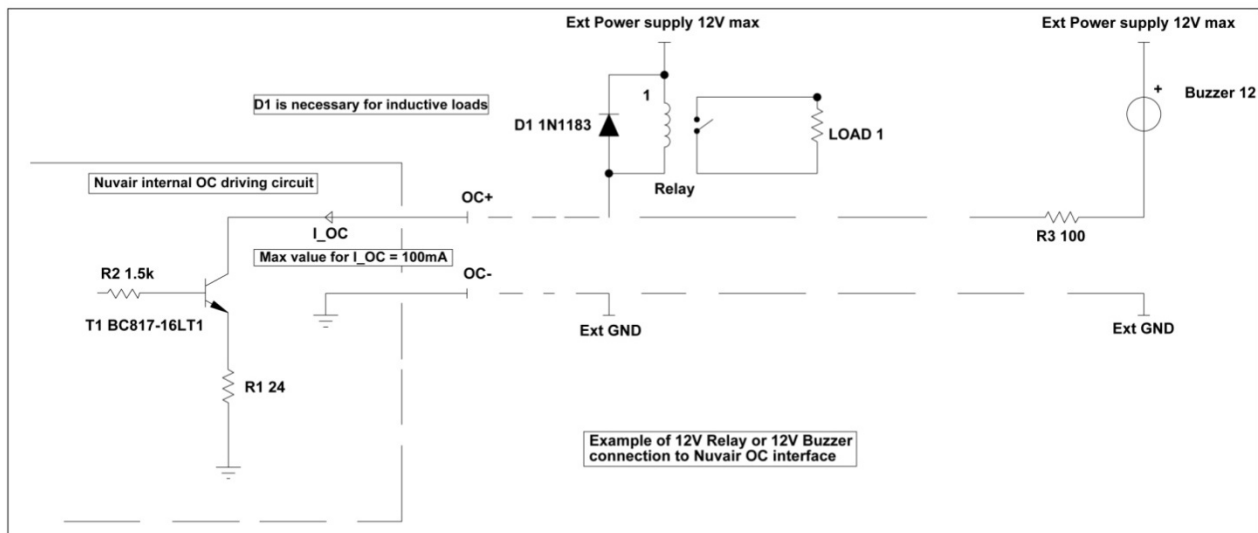

NUVAIR Pro 4 Warn Warranty

NUVAIR extends a limited warranty, which warrants the Pro 4 Warn to be free from defects in materials and workmanship under normal use and service for a limited period. The Pro 4 Warn is warranted according to the terms as set forth below. This warranty is not transferable.

NUVAIR will, at its discretion and according to the terms as set forth within, replace or repair any materials which fail under normal use and service and do not exhibit any signs of improper maintenance, misuse, accident, alteration, weather damage, tampering, or use for any other than the intended purpose. Determination of failure is the responsibility of NUVAIR, which will work together with the customer to adequately address warranty issues. When any materials are repaired or replaced during the warranty period, they are warranted only for the remainder of the original warranty period. This warranty shall be void and NUVAIR shall have no responsibility to repair or replace damaged materials resulting directly or indirectly from the use of repair or replacement parts not approved by NUVAIR.

Terms:

NUVAIR warrants the Pro 4 Warn to be free from defects in material and workmanship for a period of twelve (12) months from date of purchase, **with the exception of the O2 sensor (see sensor warranty)**. The warranty covers parts and labor.

A warranty registration card, supplied with system documentation, must be filled out and submitted to NUVAIR for the warranty to be registered. If the warranty registration card is not received within ten (10) days of purchase, the warranty will begin with the date of manufacture by NUVAIR.

Maintenance Items:

Any materials which are consumed, or otherwise rendered not warrantable due to processes applied to them, are considered expendable and are not covered under the terms of this policy. This includes batteries.

Return Policy:

Application for warranty service can be made by contacting NUVAIR during regular business hours and requesting a Return Material Authorization number. Materials that are found to be defective must be shipped, freight pre-paid, to the NUVAIR office in Oxnard, California. Upon inspection and determination of failure, NUVAIR shall exercise its options under the terms of this policy. Warranty serviced materials will be returned to the customer via NUVAIR's preferred shipping method, at NUVAIR's expense. Any expedited return shipping arrangements to be made at customer's expense must be specified in advance.

Limitation of Warranty and Liability:

Repair, replacement or refund in the manner and within the time provided shall constitute NUVAIR'S sole liability and the Purchaser's exclusive remedy resulting from any nonconformity or defect. NUVAIR shall not in any event be liable for any damages, whether based on contract, warranty, negligence, strict liability or otherwise, including without limitation any consequential, incidental or special damages, arising with respect to the equipment or its failure to operate, even if NUVAIR has been advised of the possibility thereof. NUVAIR makes no other warranty or representation of any kind, except that of title, and all other warranties, express or implied, including warranties of merchantability and fitness for a particular purpose, are hereby expressly disclaimed. No salesman or other representative of NUVAIR has authority to make any warranties.

NUVAIR O₂ Sensor Warranty

NUVAIR extends a limited warranty, which warrants O₂ sensor to be free from defects in materials and workmanship under normal use and service for a limited period. The O₂ sensor is warranted according to the pro-rated terms as set forth below. This warranty is not transferable.

NUVAIR will, at its discretion and according to the terms as set forth within, replace or repair any materials which fail under normal use and service and do not exhibit any signs of improper maintenance, misuse, accident, alteration, weather damage, tampering, or use for any other than the intended purpose. Determination of failure is the responsibility of NUVAIR, which will work together with the customer to adequately address warranty issues. When any materials are repaired or replaced during the warranty period, they are warranted only for the remainder of the original warranty period. This warranty shall be void and NUVAIR shall have no responsibility to repair or replace damaged materials resulting directly or indirectly from the use of repair or replacement parts not approved by NUVAIR.

Pro-Rated Terms:

NUVAIR warrants the O₂ sensor to be free from defects in material and workmanship for a period of twenty-four (24) months from date of purchase. The warranty covers parts and labor and is prorated as follows:

- 0 – 12 Months Free Replacement
- 13 – 18 Months 50% Off Replacement
- 19 – 24 Months 25% Off Replacement

A warranty registration card, supplied with system documentation, must be filled out and submitted to NUVAIR for the warranty to be registered. If the warranty registration card is not received within ten (10) days of purchase, the warranty will begin with the date of manufacture by NUVAIR.

Maintenance Items:

Any materials which are consumed, or otherwise rendered not warrantable due to processes applied to them, are considered expendable and are not covered under the terms of this policy.

Return Policy:

Application for warranty service can be made by contacting NUVAIR during regular business hours and requesting a Return Material Authorization number. Materials that are found to be defective must be shipped, freight pre-paid, to the NUVAIR office in Oxnard, California. Upon inspection and determination of failure, NUVAIR shall exercise its options under the terms of this policy. Warranty serviced materials will be returned to the customer via NUVAIR's preferred shipping method, at NUVAIR's expense. Any expedited return shipping arrangements to be made at customer's expense must be specified in advance.

Limitation of Warranty and Liability:

Repair, replacement or refund in the manner and within the time provided shall constitute NUVAIR'S sole liability and the Purchaser's exclusive remedy resulting from any nonconformity or defect. NUVAIR shall not in any event be liable for any damages, whether based on contract, warranty, negligence, strict liability or otherwise, including without limitation any consequential, incidental or special damages, arising with respect to the equipment or its failure to operate, even if NUVAIR has been advised of the possibility thereof. NUVAIR makes no other warranty or representation of any kind, except that of title, and all other warranties, express or implied, including warranties of merchantability and fitness for a particular purpose, are hereby expressly disclaimed. No salesman or other representative of NUVAIR has authority to make any warranties.

Additional Record of Changes

It is the responsibility of the owner of this product to register their ownership with Nuvair by sending the warranty card provided to Nuvair. This card is to establish registration for any necessary warranty work and as a means of communication that allows Nuvair to contact the user regarding this product.

The user must notify Nuvair of any change of address by the user or sale of the product. All changes or revisions to this manual must be recorded in this document to ensure that the manual is up to date.

Change Date	Description of Change
04/2013	Updated warnings and cautions throughout manual
05/2013	Added abbreviation and definition information
08/2017	Updated Warranty Terms



Nuvair™
Phone (805) 815-4044
Fax (805) 486-0900
1600 Beacon Place
Oxnard, CA 93033 USA
Email : info@nuvair.com
Web : www.nuvair.com