



User Manual

Pro CO Alarm
Carbon Monoxide Analyzer

Rev. 08.22

Quick Reference Guide

READ ENTIRE MANUAL BEFORE USE

1. To switch on, hold the On/Off button until the display powers up.
2. To turn off, hold the On/Off button until the display goes blank.
3. Gas flow to the analyzer should be regulated to .5-5 L/min with no pressure on the sensor. Pressurizing the sensor will lead to inaccurate readings and could damage it.
4. If using a Nuvair 9517.6 flow reducer for sample flow, the incoming pressure should be 75-150 PSI.
5. Press and hold the Adjust button to view the battery voltage and current ambient temperature in Celsius.
 - a. Conversion formula to Fahrenheit: $(^{\circ}\text{C} \times 1.8) + 32 = ^{\circ}\text{F}$
6. Press and hold the Prog button to access the programming pages for:
 - a. Alarm 1 (AL1) sets the low level alarm (setting to 300 turns this off).
 - b. Alarm 2 (AL2) sets the high level alarm (setting to 300 turns this off).
 - c. Full Scale Value (FSC) sets the mA value for the optional output.
 - d. Conversion Value (nA) is only to be set when a new sensor is installed.
 - e. Gain Factor (Fct) is only to be set when a new sensor is installed.
 - f. Calibration value (CAL) is to be adjusted to the CO content of the certified calibration test gas being used.
 - g. End is displayed after the last programming page. The display will then return to the current gas reading value.
7. Press the On/Off button to cycle through the programming screens, the Prog button to change the value of the blinking digit, and the Adjust button to select which digit to program.
8. To calibrate the **Analyzer Span**:
 - a. Turn on the analyzer and program the CAL value to the CO content of the calibration gas to be used.
 - b. Connect the sensor to calibration gas and allow to flow for 2-3 minutes. Flow should be regulated to 1 L/min with no pressure on the sensor.
 - c. When the reading is stable, press the On/Off and Adjust buttons simultaneously and hold until the display flashes "Cal".
 - d. The unit is calibrated once the screen returns to the gas reading display. If the reading drifts after calibration, allow the unit to sit while turned on for a few minutes so the sensor temperature can stabilize, then repeat steps a-c.
9. To calibrate the **Analyzer Zero**:
 - a. Turn on the analyzer.
 - b. Attach a flow of certified 0 PPM CO, 100% Nitrogen test gas regulated to .5-3 L/min.
 - c. Press the Prog and Adjust buttons simultaneously and hold until the display flashes "Cal".
 - d. When the display returns to reading 000, the zero has been set.
10. If equipped with a lithium battery, read and understand all instructions included with the battery charger.
11. Any wind or breeze present while using the analyzer can affect readings.

If you have any questions on this equipment please contact Technical Support at:

Nuvair
1600 Beacon Place
Oxnard, CA 93033

Phone: +1 805 815 4044
FAX: +1 805 486 0900
Email: info@nuvair.com

Hours: Monday through Friday
8:00 AM to 5:00 PM PT USA

Warning

This User Manual contains important safety information and should always be available to those personnel operating this equipment. Read, understand, and retain all instructions before operating this equipment to prevent injury or equipment damage.

Every effort was made to ensure the accuracy of the information contained within this manual; however, we retain the right to modify its contents without notice. If you have problems or questions after reading the manual, stop and call for information.

Warning

Never expose gas sensors to pressure or you may cause damage and/or false readings. Damaged sensors will not provide accurate gas analysis. Most gas analyzers can be used to analyze a regulated gas sample flow, the contents of a gas cylinder, or the flow from a regulator. The flow rate of gas must equal 1-5 L/min. To produce this flow, a Flow Restrictor and Regulator may be required. A faulty Flow Restrictor can lead to a false analyzer reading. Flow Restrictors should be regularly tested with a Flow Meter. Inaccurate gas analysis can lead to serious personal injury or death.

Table of Contents

1.0 Introduction.....	5
2.0 System Description.....	6
2.1 Controls.....	7
2.2 Display.....	7
2.3 Alarm.....	7
2.4 Sensor.....	7
2.5 Batteries.....	7
2.6 Flow Adapter Cap.....	8
3.0 Calibration.....	8
3.1 Sample Flow Method.....	9
4.0 Operation.....	10
4.1 Programming Procedures.....	11
4.2 Alarm Setting.....	12
4.3 Full Scale Value Setting.....	12
4.4 Conversion Value of Carbon Monoxide Sensor.....	13
4.5 Gain Factor	14
4.6 Calibration Value.....	15
5.0 Threshold Alarms.....	15
6.0 Powering Off.....	15
7.0 Factory Reset.....	16
8.0 Maintenance.....	16
8.1 Analyzer Care.....	16
8.2 9V Battery Replacement.....	17
8.3 Sensor Replacement.....	18
8.3.1 Handling Sensor.....	18
9.0 Spares and Accessories.....	20
9.1 Sensor.....	20
9.2 Calibration Equipment.....	20
10.0 Troubleshooting.....	20
11.0 Relay Output Schematics.....	21
Appendix	
Analyzer Specifications.....	22
Warranty.....	23

1.0 Introduction

This manual will assist you in the proper set-up, operation and maintenance of the Pro CO™ Carbon Monoxide Analyzer. Be sure to read the entire manual.

Throughout this manual we will use certain words to call your attention to conditions, practices or techniques that may directly affect your safety. Pay particular attention to information introduced by the following signal words:

Danger

Indicates an imminently hazardous situation, which if not avoided, will result in serious personal injury or death.

Warning

Indicates a potentially hazardous situation, which if not avoided, could result in serious personal injury or death.

Caution

Indicates a potentially hazardous situation, which if not avoided, may result in minor or moderate injury. It may also be used to alert against unsafe practices.

Notice

Notifies people of installation, operation or maintenance information which is important but not hazard-related.

2.0 System Description

The Pro CO™ Carbon Monoxide Analyzer measures carbon monoxide (CO) levels in gases in the range of 0 to 100 parts per million (ppm). It can be used to measure the CO content in gas mixes that may be contaminated due to the introduction of CO from internal combustion engines or other devices where CO is a byproduct. The Analyzer is designed to verify CO concentration in stored gas cylinders as well as to monitor enclosed spaces. The Analyzer is a water and impact resistant unit compatible with outdoor and marine environments.

Danger

Carbon monoxide is a colorless, odorless, tasteless gas that will not support life. Exposure to carbon monoxide can lead to unconsciousness and death.

The Analyzer is battery powered and includes an internally mounted Sensor with audible alarm. The Water-Resistant Case includes a Digital Display and controls that are environmentally sealed

The Analyzer uses a Flow Adapter Cap and Flexible tubing to deliver sample gas to the Sensor. Pressurized gases must be regulated to avoid damage to the analyzer. Use of this Analyzer in a hyperbaric chamber will void the owner's warranty.

The Analyzer comes in a high impact storage case. It is ready for use after calibration with an appropriate certified calibration gas.

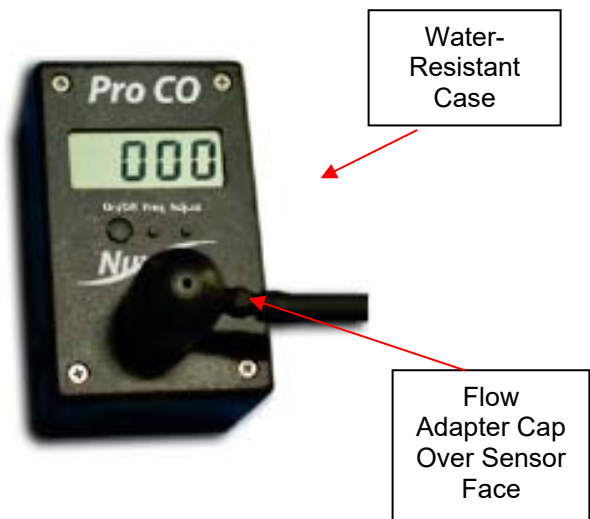

Warning

This analyzer is designed for use at atmospheric pressures only. It is not designed for exposures in a hyperbaric chamber. Use of this analyzer in a hyperbaric chamber will result in incorrect readings and may damage the unit.

Warning

Although the Analyzer is a rugged instrument, careless handling or abuse may result in damage to the Analyzer resulting in inaccurate gas analysis. Inaccurate gas analysis can lead to serious personal injury or death.

Notice

Extreme CO exposure levels directed at the Analyzer sensor may damage the sensor. Don't test the sensor in the direct flow of any engine mufflers/exhausts or any other known high concentrations of CO.

2.1. Controls



2.2. Display

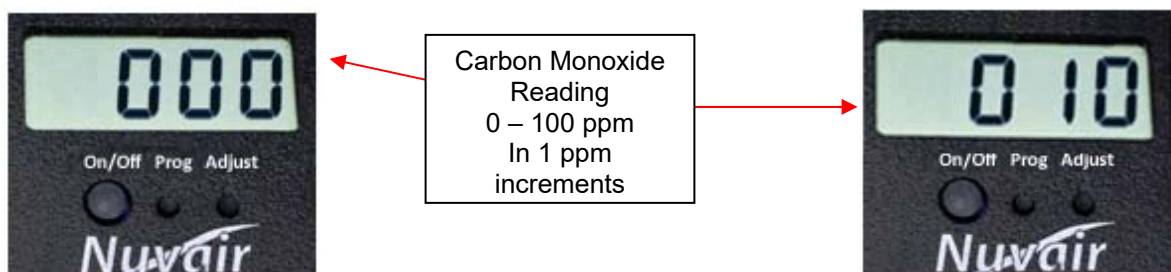

2.3. Alarm

The Analyzer includes an audible alarm that is activated when the Sensor reaches 10 ppm CO or user programmed level. The alarm will not clear until the concentration of CO drops below 10 ppm or user programmed level.

2.4. Sensor

The Analyzer uses an electrochemical CO Sensor to measure CO content in gases. The Sensor is disposable and user-replaceable, with a life expectancy of up to 24 months depending on usage. The Sensor is designed for use at atmospheric pressure (0 psi). The gas mixture to be analyzed must be regulated accordingly, and any potential for pressure or vacuum must be avoided.

2.5. Batteries

One standard 9-volt battery or rechargeable Lithium battery provides power. The battery is located inside the Analyzer and is user-replaceable. The battery should be removed any time the Analyzer will be stored without use for extended periods of time. Screen will blink alternately from "000" to "bAt" at start up when battery is low.

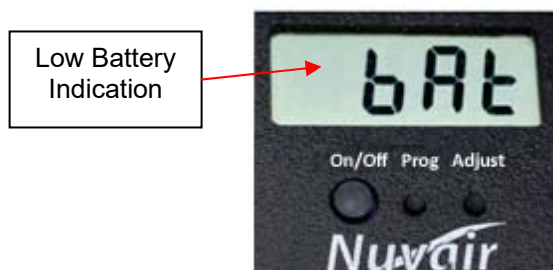

2.6. Flow Adapter Cap

The Analyzer includes a Flow Adapter Cap with flexible tubing and flow orifice. It attaches to the Sensor port and is sealed by an o-ring. It can be used to direct the gas sample flow to the Sensor via one of two methods:

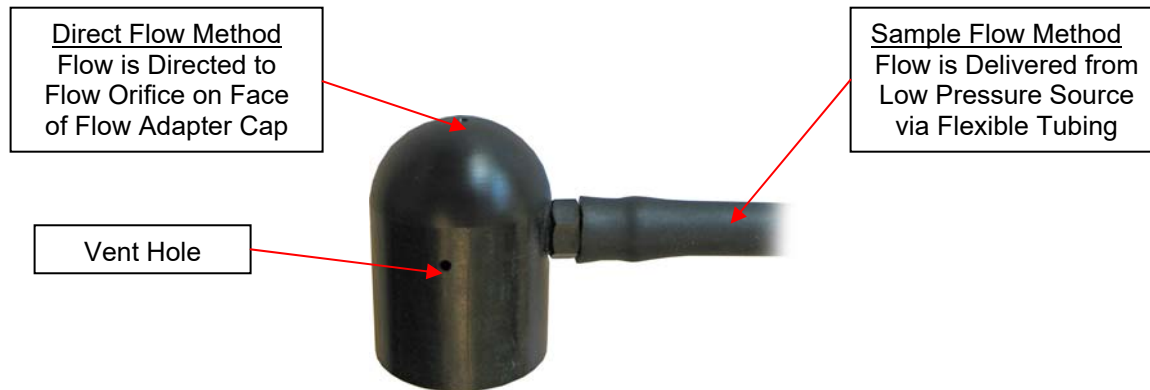

3.0 Calibration

Warning

Analyzer calibration must be verified on a weekly basis. Improper calibration may result in an incorrect reading, exposing the user to dangerous levels of carbon monoxide. Exposure to carbon monoxide can lead to unconsciousness and death.

Warning

This Analyzer must always be checked against a calibration gas and used with gases regulated and supplied at atmospheric pressure (0 psi). Use of gases at higher pressures may result in incorrect readings and may damage the Analyzer. Incorrect readings may expose the user to high levels of carbon monoxide resulting in personal injury or death.

Warning

Checking Calibration or use of the Analyzer with a low battery may result in inaccurate readings. Inaccurate gas analysis can lead to serious personal injury or death.

Notice

If the Analyzer has been subjected to a recent change in ambient temperature, allow it to stabilize for one hour before checking calibration.

Verify calibration on a weekly basis. Breathing gas applications require the use of a certified CO calibration gas with a 10 ppm concentration and flow rate of 1 L/min. The equipment to produce this flow is available from Nuair. See Spares and Accessories section.

To assure the greatest accuracy for other applications, use the calibration gas concentration closest to the expected concentration in the gas being measured.

To calibrate the Analyzer Span:

1. Move to an area with no wind. Wind can affect the analyzer reading and lead to an incorrect calibration.
2. Power the unit on and allow it to complete its startup.
3. Hold the Prog button down until the Alarm 1 setting is flashing on the screen.
4. Repeatedly press the On/Off button to cycle through the menu until the screen flashes "CAL"
5. Using the Program and Adjust buttons, set the Cal number to match the exact measurement of CO PPM in the calibration gas to be used.
6. Use the Power button to cycle to the home screen.
7. Attach the calibration gas and ensure that gas flow is 1 L/min.
8. Once the display has settled, you can either confirm that calibration is correct, or that a new calibration must be performed.
9. To calibrate the unit, press and hold the Power and Adjust buttons simultaneously until the display flashes CAL. The unit will now recalibrate to the gas flow based on the value input in the CAL programming screen.
10. If the reading drifts after a calibration has been performed, allow the unit to sit for several minutes while powered on before attempting recalibration.

To calibrate the Analyzer Zero:

1. Power the unit on and allow it to complete its startup.
2. Attach certified 0 PPM 100% Nitrogen calibration gas and ensure that gas flow is 1 L/min.
3. Press the On/Off and Prog buttons simultaneously and hold until the screen flashes "Cal"
4. When the display returns to reading 000, the zero has been set.

Nuvair offers CO gas testing kits - see addendum for more information

3.1. Sample Flow Method of Checking Calibration (Preferred)

Step 1. Attach Flexible Tubing to Gas Sample Flow of 1 L/min



Step 2. Verify that Gas is Flowing Out Holes in Flow Adapter Cap



Step 3. Allow 15 Seconds for Display Reading to Stabilize

Step 4. Record Reading while Gas is Flowing



4.0 Operation

Prior to each Analyzer use:

- 1) Shield the analyzer from wind. Wind can affect the analyzer reading.
- 2) Turn unit on and monitor Display for low battery warning. Replace battery immediately if warning appears. Once fully cycled the screen should read "000"

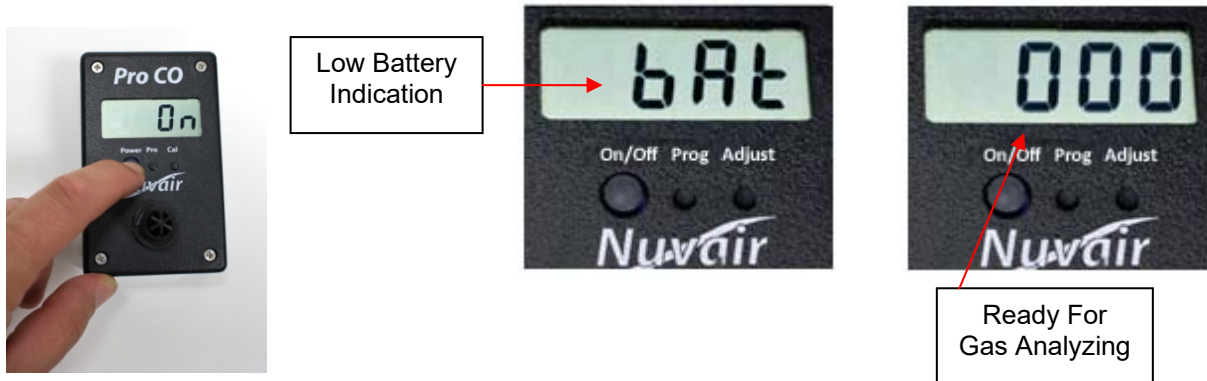

- 3) Cycle through the current settings of the analyzer.
 - a. Hold down the Prog button for 2 seconds then use the "Power" button to cycle through the 1st Alarm Value, 2nd Alarm Value, Full Scale Value, Conversion Value of the Sensor, Gain Factor, and Calibration value.
 - b. Adjust Alarm values at this time if needed see "4.2"
- 4) Check Calibration of Analyzer using "Calibrated Test Gas"

Warning

Do not test cylinders suspected of containing carbon monoxide in a confined space that does not have good ventilation. Exposure to carbon monoxide can lead to unconsciousness and death.

Warning

Gas, even under moderate pressures, can cause extreme bodily harm. Never allow any gas stream to be directed at any part of your body.

Warning

Never expose the sensor to pressures above atmospheric pressure (0 psi) or you may cause damage to the sensor and/or receive false readings. Damaged Sensors will not provide accurate gas analysis. Inaccurate gas analysis can lead to serious personal injury or death.

The Pro CO™ can be used to monitor an enclosed space or to analyze a regulated gas sample flow, the contents of a gas cylinder, or the flow from a regulator:

- If monitoring an enclosed space, simply remove the Flow Adapter Cap to expose the Sensor face to the atmosphere and allow the display reading to stabilize.
- If analyzing a gas flow, the Sample Flow Method is the preferred method. The flow rate must equal .5 to 5 L/min at atmospheric pressure. To produce this flow, a Flow Restrictor and Regulator may be required. Contact Nuair if you need assistance.

4.1. Programming Procedures

Keep the Prog button pressed for more than two seconds and then release the button. “Pr” should display for two seconds and then the display will change to AL 1 and alternate with the 3 digit set value.

It is possible to program:

- **AL 1** First alarm point expressed in ppm of Carbon Monoxide concentration
- **AL 2** Second alarm point expressed in ppm of Carbon Monoxide concentration
- **FSC** Value expressed in ppm of Carbon Monoxide concentration corresponding to the current output full scale value (20mA). 4mA always correspond to zero ppm CO concentration.
- **nA** Conversion value of Carbon Monoxide sensor
- **Fct** Gain factor
- **CAL** CO concentration in the calibration test gas to be used

At the end of the programming procedure the display will show “End” and the instrument will display the Carbon Monoxide content in the gas mix or “000” if not attached to a CO gas mix.

4.2. Alarm Setting (AL 1 & AI 2)

- 1.) Press the Prog button until the display reads “Pr”, then “AL1”. After a second the display will show the current value of “AL1” CO PPM setting.
- 2.) The blinking digit shows the cursor position.
- 3.) Press the Prog button to increase the value (from 0 to 9)
- 4.) Press the Adjust button to cycle the cursor through the digits.
- 5.) To complete your entry and save the CO PPM value, press the On/Off button. You will then move to the “AL 2” programming view.
- 6.) Repeat steps 3 through 5 to modify and save the “AL 2” CO PPM desired value.
- 7.) Once programming of “AL 2” is complete, press the On/Off button repeatedly until the next desired program page is displayed or the end screen appears.

4.3. Full Scale Value Setting (FSC)

On the “FSC” page you can change the analog full scale value. It is not necessary to modify this value unless a new sensor is installed. This is the Carbon Monoxide concentration corresponding to 20 mA on the analog output. 4mA is the value at 0 ppm of Carbon Monoxide. When installing a new sensor, input the “Fsc” value displayed on the new sensor here AND in the “Fct” value.

- 1.) Press and hold the “Prog” button to access the program pages, then release the button.
- 2.) Press the On/Off button to cycle through the settings until you reach the “FSC” view.
- 3.) The blinking digit shows the cursor position.
- 4.) Press the Prog button to increase the value (from 0 to 9)
- 5.) Press the Adjust button to cycle the cursor through the digits.
- 6.) To complete your entry and save the FSC value, press the On/Off button repeatedly until the next desired program page is displayed or the end screen appears.
- 7.) ***This procedure is used ONLY when a new sensor has been ordered from NuVair and is ready to be installed.***

4.4. Conversion Value of Carbon Monoxide Sensor (nA)

The “nA” value is the conversion value of the Carbon Monoxide sensor in nano Ampere. It is not necessary to modify this value except when a new sensor is installed. The new sensor is provided with the new value to be set on this screen.

- 1.) Press and hold the “Prog” button to access the program pages, then release the button.
- 2.) Press the On/Off button to cycle through the settings until you reach the “nA” view.
- 3.) The blinking digit shows the cursor position.
- 4.) Press the Prog button to increase the value (from 0 to 9)
- 5.) Press the Adjust button to cycle the cursor through the digits.
- 6.) To complete your entry and save the nA value, press the On/Off button repeatedly until the next desired program page is displayed or the end screen appears.
- 7.) ***This procedure is used ONLY when a new sensor has been ordered from Nuvaair and is ready to be installed.***

Warning

The conversion value of the Carbon Monoxide sensor is set in factory and must be changed only when the CO sensor is replaced. The new sensor will come from the factory with a label showing the new “nA” value to be programmed. A wrong value of this parameter will give a wrong reading of CO concentration. If it is modified the conversion value of the Carbon Monoxide sensor, the instrument will be no more accurate. All the analysis concentration shown on the display will be wrong. Do not modify this value. It is necessary to modify this value only at the installation of a new sensor. Wrong Carbon Monoxide analysis may lead to death.

4.5. Gain Factor (Fct)

The “Fct” value is the conversion value of gain factor. It is not necessary to modify this value except when a new sensor is installed. The new sensor is provided with the new value to be set on this screen. The value is referred to as the “Fsc” number on the sensor.

- 1.) Press and hold the Prog button to access the program pages, then release the button.
- 2.) Press the On/Off button to cycle through the settings until you reach the “FSC” view.
- 3.) The blinking digit shows the cursor position.
- 4.) Press the Prog button to increase the value (from 0 to 9)
- 5.) Press the Adjust button to cycle the cursor through the digits.
- 6.) To complete your entry and save the Gain Factor value, press the On/Off button repeatedly until the next desired program page is displayed or the end screen appears.
- 7.) ***This procedure is used ONLY when a new sensor has been ordered from Nuvair and is ready to be installed.***

Warning

Then gain factor is set in factory and must be changed only when the CO sensor is replaced. The new sensor will come from the factory with a label showing the new ‘Fct’ value to be programmed. A wrong value of this parameter will give a wrong reading of CO concentration. If it is modified the gain factor instrument will be no more accurate. All the analysis concentration shown on the display will be wrong. Do not modify this value. It is necessary to modify this value only at the installation of a new sensor. Wrong Carbon Monoxide analysis may lead to death.

4.6. Calibration Value (CAL)

The "CAL" value corresponds to the CO PPM content of the calibration test gas to be used for calibration

- 1.) Press and hold the Prog button to access the program pages, then release the button.
 - 2.) Press the On/Off button to cycle through the settings until you reach the "CAL" view.
 - 3.) The blinking digit shows the cursor position.
 - 4.) Press the Prog button to increase the value (from 0 to 9)
 - 5.) Press the Adjust button to cycle the cursor through the digits.
- To complete your entry and save the Calibration value, press the On/Off button repeatedly until the next desired program page is displayed or the end screen appears.

5.0. Threshold Alarms

Should the Carbon Monoxide reading go over the threshold alarms (AL1 or AL2) the instrument will go into alarm mode and will activate the relays output (open collector max 100mA) and the internal buzzer. The display will show the trespassed alarm and the actual measured value. To stop the audible alarm, press any key. In this event the Pro Co Analyzer will remain in alarm mode until the analyzed value goes below the alarm set point.

The relay output typically is used to shut down the compressor. Nuvair can supply the necessary components to adapt your compressor to the relay or provide them at the time of install on a new compressor.

6.0. Powering Off

At the home or gas reading screen, hold down the On/Off button for a couple of seconds. The Analyzer will display "OFF" and then go blank.



7.0. Factory Reset

In case it is necessary to reset the Pro CO Analyzer to the factory settings, power on the Analyzer pressing at the same time for more than one second the Power and “Cal” buttons. On the display will appear “res” and the instrument will go to the reading page.

You will need to open the Pro CO analyzer and get the Values from the sensor for inputting into the PRO CO analyzer before using.

Warning

In case of reset, the instrument will delete all the alarms settings, the full scale value, any new conversion value of Carbon Monoxide sensor and of the gain factory. Before using again the instrument, it may be necessary to program again the alarm values, the full scale value, and the conversion value of Carbon Monoxide sensor and gain factor if changed. All the analysis concentration shown on the display would be wrong. Wrong Carbon Monoxide analysis may lead to death.

8.0. Maintenance

8.1. Analyzer Care

Warning

Analyzers immersed in liquid or stored in wet environments may not operate properly. This may result in incorrect readings. Incorrect gas analysis may result in personal injury or death.

Warning

Protect the analyzer from excessive shock and impact. Excessive shock and impact may result in incorrect readings. Incorrect gas analysis may result in personal injury or death.

Warning

Protect the analyzer from exposure to hyperbaric environments. Exposure to hyperbaric environments may result in incorrect readings. Incorrect gas analysis may result in personal injury or death.

- Do not clean Analyzer with anything other than a damp soft cloth.
- Do not immerse in liquid, leave unprotected outside, or store in a wet environment.
- Protect Analyzer from excessive shock and impact.
- Protect Analyzer from excessive exposure to sunlight and extreme temperatures.
- Do not use the Analyzer in a hyperbaric environment.

8.2. 9 V Battery Replacement

Notice

Be sure to dispose of spent, leaking, or damaged Battery properly, according to local regulations.

The following pictures illustrate the steps required to replace the batteries in the Analyzer.

Step 1. Remove
Screws

Step 2. Remove
Back Cover

Step 4. Replace
Back Cover -
Do Not Pinch
Wires

Step 5.
Reinstall
Screws



Step 3.
Remove &
Replace Old
Battery

Step 6. Turn
Analyzer On

Step 7.
Perform
Calibration



***Contact Nuvair for replacement if the battery life of a Lithium battery should noticeably degrade.**

8.3. Sensor Replacement

You should take note of your “Fsc” Number and “nA” Number before installing a new sensor. The “Fsc” number is programmed into the Pro CO Analyzer at the “Fct” and “Fsc” setting. This information will be used to program the Pro CO analyzer after the sensor is installed.

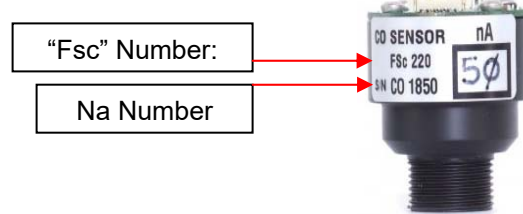

⚠ Caution

Be sure to dispose of spent, leaking, or damaged Sensors properly, according to local regulations.

⚠ Danger

Do not swallow (ingest) either the electrolyte from the Sensor or the Sensor itself. The Potassium hydroxide chemical contained in the Sensor will cause severe injury or death. If electrolyte or the Sensor is swallowed, seek medical attention immediately.

⚠ Warning

If after handling the Analyzer or Sensor, you find that your fingers or other parts of your body feel “slippery” or the skin or eyes sting, immediately flush affected area with clean, fresh water for at least 15 minutes. The stinging or slippery sensation is an indication of a leaking Sensor. The Potassium Hydroxide chemical contained in the Sensor can cause severe injury or death. Seek immediate medical attention if eye contact is made or skin stinging persists.

8.2.1 Handling Sensors

Replacement Sensors are supplied in sealed bags. Normally Sensors do not present a health hazard. Before opening the bag, check that the electrolyte has not leaked. However, if electrolyte leakage has occurred, do not open bag. Dispose of Sensor properly or return for replacement.

If electrolyte leakage occurs while the Sensor is in service, use rubber gloves and chemical splash goggles for handling. Rinse contaminated surfaces thoroughly with water.

Electrolyte First Aid Procedures

- Ingestion - Drink a large volume of fresh water. Do not induce vomiting. Get immediate medical attention.
- Eye Contact - Flush eyes with clean, fresh water for at least 15 minutes and get medical help immediately.
- Skin Contact - Flush the affected area with clean, fresh water for at least 15 minutes and removed contaminated clothing. If stinging persists get medical attention.

The following pictures illustrate the steps required to replace the Sensor in the Analyzer.

Step 1.
Remove Flow
Adapter Cap



Step 2.
Remove
Screws

Step 3.
Remove
Back



Step 4.
Disconnect
Electrical
Connector



Step 5. Remove
Old Sensor from
Case by
Unscrewing

Step 6. Replace
with New
Sensor



Step 7. Remove
Shorting Plug from
Sensor Electrical
Connector & Reconnect

Note: Reversing Polarity
Will Cause Display to
Read Negative



Step 8.
Replace
Front Cover
- Do Not
Pinch Wires

Step 9.
Reinstall
Screws



Step 10. Replace
Flow Adapter Cap

Step 11. Turn
Analyzer On

Step 12. Check
Calibration



9.0 Spares and Accessories

9.1. Sensors

Sensor replacement for Pro CO
Part Number: **9501-50**



9.2. Calibration Equipment

Calibration requires certified CO calibration gas to be delivered at a specific flow rate and pressure.

A variety of calibration gas canisters are available from Nuair, with compatible Flow Restrictor/Regulator assemblies to regulate the gas.

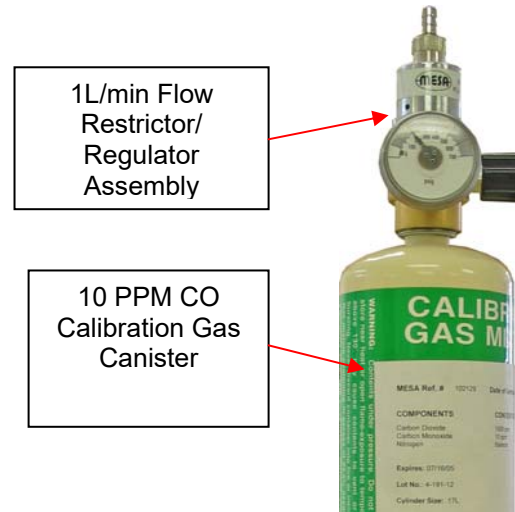

10.0 Troubleshooting

SYMPTOM	REASON	SOLUTION
Battery symbol	Low Battery	Change the battery
No display	Switched off Bad connection Low Battery	Switch on, Check display/ battery connection, Change the battery
Reading erratic	Pressure on sensor Radio transmission Sensor old or faulty Condensation on sensor.	Check flow, Move unit away, Change sensor, Dry in air
Display segments missing	Display faulty	Return to dealer
Reading drifts	Rapid temperature change	Stabilize temperature & recalibrate
Will not calibrate	Sensor Malfunction	Contact Nuair for repair or replacement

11.0 Relay Output Schematics

4-20mA Connections: The relay output uses a special “Mini Jack” plug that can be purchased separately from Nuair. Insert the plug into the output jack. Connections diagram below for additional wiring.

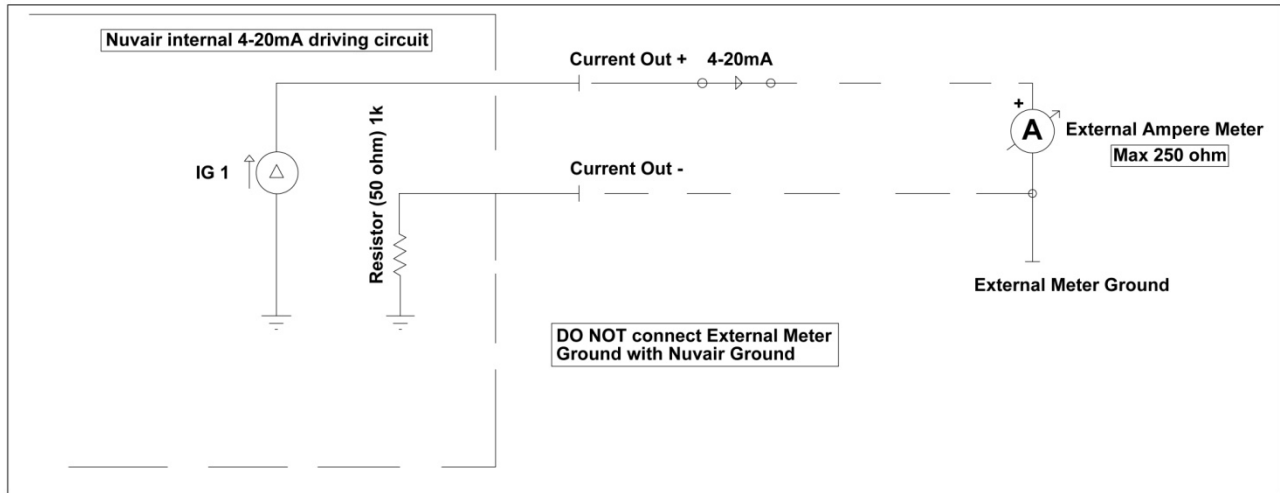

Warning

The plug should be connected or disconnected when the instrument is switched off, or the instrument will automatically switch off.

Open Collector Connections:

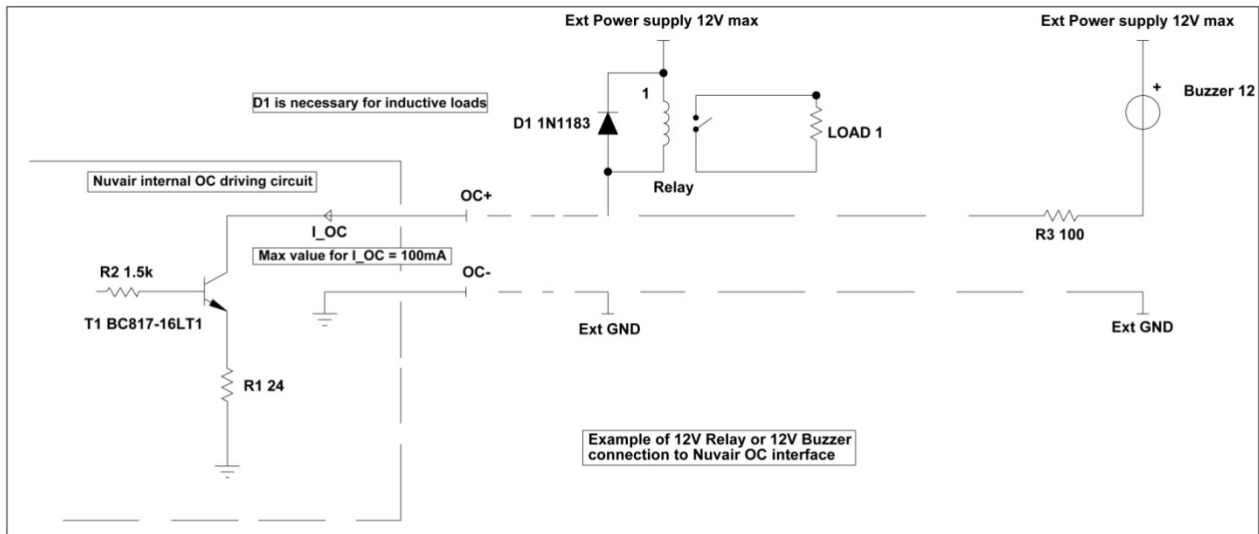

Appendix

Analyzer Specifications

Range:	0.5-5 L/min
Resolution:	1 ppm
Repeatability:	<+5%
Accuracy:	+/- 5%
Sensor Type:	Electrochemical
Expected Sensor Life:	>24 months in normal use from date of manufacture
Range:	0-50 PPM CO
Alarms:	Two user-programmable audible and visual alarms
Response Time:	<50 seconds over complete temperature range
Stabilization Time:	15 minutes when first installed
Power:	9 volt battery, rechargeable lithium battery, 12 volt DIN rail, or 110/230 volt wall plug-in
Operating Temperature:	14 to 122°F (-10 to 50°C)
Storage Temperature:	14 to 140°F (-10 to 60°C)
Operating Pressure:	Not to exceed 1 atmosphere absolute (0 psi)
Operating Humidity:	Non-condensing: 15-90% continuous 0-99% intermittent

Note: All specifications are at ambient / sea level, 77°F / 25°C

Nuvair Pro CO Warranty

Nuvair extends a limited warranty, which warrants the Pro CO™ to be free from defects in materials and workmanship under normal use and service for a limited period. The Pro CO is warranted according to the terms as set forth below. This warranty is not transferable.

Nuvair will, at its discretion and according to the terms as set forth within, replace or repair any materials which fail under normal use and service and do not exhibit any signs of improper maintenance, misuse, accident, alteration, weather damage, tampering, or use for any other than the intended purpose. Determination of failure is the responsibility of Nuvair, which will work together with the customer to adequately address warranty issues. When any materials are repaired or replaced during the warranty period, they are warranted only for the remainder of the original warranty period. This warranty shall be void and Nuvair shall have no responsibility to repair or replace damaged materials resulting directly or indirectly from the use of repair or replacement parts not approved by Nuvair.

Terms:

Nuvair warrants the Pro CO to be free from defects in material and workmanship for a period of twelve (12) months from date of purchase. The warranty covers parts and labor.

A warranty registration card, supplied with system documentation, must be filled out and submitted to Nuvair for the warranty to be registered. If the warranty registration card is not received within ten (10) days of purchase, the warranty will begin with the date of manufacture by Nuvair.

Maintenance Items:

Any materials which are consumed, or otherwise rendered not warrantable due to processes applied to them, are considered expendable and are not covered under the terms of this policy. This includes batteries.

Return Policy:

Application for warranty service can be made by contacting Nuvair during regular business hours and requesting a Return Material Authorization number. Materials that are found to be defective must be shipped, freight pre-paid, to the Nuvair office in Oxnard, California. Upon inspection and determination of failure, Nuvair shall exercise its options under the terms of this policy. Warranty serviced materials will be returned to the customer via Nuvair's preferred shipping method, at Nuvair's expense. Any expedited return shipping arrangements to be made at customer's expense must be specified in advance.

Limitation of Warranty and Liability:

Repair, replacement or refund in the manner and within the time provided shall constitute Nuvair's sole liability and the Purchaser's exclusive remedy resulting from any nonconformity or defect. Nuvair shall not in any event be liable for any damages, whether based on contract, warranty, negligence, strict liability or otherwise, including without limitation any consequential, incidental or special damages, arising with respect to the equipment or its failure to operate, even if Nuvair has been advised of the possibility thereof. Nuvair makes no other warranty or representation of any kind, except that of title, and all other warranties, express or implied, including warranties of merchantability and fitness for a particular purpose, are hereby expressly disclaimed. No salesman or other representative of Nuvair has authority to make any warranties.



Nuvair
Phone +1 805 815 4044
Fax +1 805 486 0900
1600 Beacon Place
Oxnard, CA 93033
USA
info@nuvair.com
www.nuvair.com