



User Manual

# **Pro CO LP Alarm**

Carbon Monoxide Analyzer  
and  
Low Pressure Monitor with Alarm

REV: 06.20



## **Quick Reference Guide**

### **READ ENTIRE MANUAL BEFORE USE**

1. To switch on, hold the On/Off button until the display powers up.
2. To turn off, hold the On/Off button until the display goes blank.
3. Gas flow to the analyzer should be regulated to .5-5 L/min with no pressure on the sensor. Pressurizing the sensor will lead to inaccurate readings and could damage it.
4. If using a Nuvaair 9517.6 flow reducer for sample flow, the incoming pressure should be 75-100 psi.
5. Press and hold the Adjust button to view the battery voltage and current ambient temperature in Celsius.
  - a. Conversion formula to Fahrenheit:  $(^{\circ}\text{C} \times 1.8) + 32 = ^{\circ}\text{F}$
6. Press and hold the Prog button to access the programming pages for:
  - a. Alarm 1 (AL1) sets the low level alarm (setting to 300 turns this off).
  - b. Alarm 2 (AL2) sets the high level alarm (setting to 300 turns this off).
  - c. Full Scale Value (FSC) sets the mA value for the optional output.
  - d. Conversion Value (nA) is only to be set when a new sensor is installed.
  - e. Gain Factor (Fct) is only to be set when a new sensor is installed.
  - f. Calibration value (CAL) is to be adjusted to the CO content of the certified calibration test gas being used.
  - g. End is displayed after the last programming page. The display will then return to the current gas reading value.
7. Press the On/Off button to cycle through the programming screens, the Prog button to change the value of the blinking digit, and the Adjust button to select which digit to program.
8. To calibrate the **Analyzer Span**:
  - a. Turn on the analyzer and program the CAL value to the CO content of the calibration gas to be used.
  - b. Connect the sensor to calibration gas and allow to flow for 2-3 minutes. Flow should be regulated to 1 L/min with no pressure on the sensor.
  - c. When the reading is stable, press the On/Off and Adjust buttons simultaneously and hold until the display flashes "Cal".
  - d. The unit is calibrated once the screen returns to the gas reading display. If the reading drifts after calibration, allow the unit to sit while turned on for a few minutes so the sensor temperature can stabilize, then repeat steps a-c.
9. To calibrate the **Analyzer Zero**:
  - a. Turn on the analyzer.
  - b. Attach a flow of certified 0 PPM CO, 100% Nitrogen test gas regulated to 1 L/min.
  - c. Press the On/Off and Prog buttons simultaneously and hold until the display flashes "Cal".
  - d. When the display returns to reading 000, the zero has been set.
10. If equipped with a lithium battery read and understand all instructions included with the battery charger.

If you have any questions on this equipment please contact Technical Support at:

Nuvair  
1600 Beacon Place  
Oxnard, CA 93036

Phone: +1 805 815 4044

Fax: +1 805 486 0900

Email: [info@nuvair.com](mailto:info@nuvair.com)

Hours: Monday through Friday  
8:00 AM to 5:00 PM PST USA

## **Warning**

**This User Manual contains important safety information and should always be available to those personnel operating this equipment. Read, understand, and retain all instructions before operating this equipment to prevent injury or equipment damage.**

Every effort was made to ensure the accuracy of the information contained within this manual; however, we retain the right to modify its contents without notice. If you have problems or questions after reading the manual, stop and call Nuvair for information.

## Table of Contents

<b>1.0</b>	Introduction .....	3
<b>2.0</b>	System Description.....	4
<b>2.1</b>	Display.....	6
<b>2.2</b>	Alarm.....	6
<b>2.3</b>	Sensor.....	6
<b>2.4</b>	Low Pressure Alarm.....	6
<b>2.5</b>	Battery.....	6
<b>2.6</b>	Low Pressure Air Inlet.....	6
<b>3.0</b>	Installation .....	7
<b>4.0</b>	Operation .....	7
<b>5.0</b>	Calibration .....	9
<b>5.1</b>	Sample Flow Method of Checking Calibration .....	11
<b>6.0</b>	Programming Procedures.....	12
<b>6.1</b>	Alarm Setting (AL1 & AL2).....	13
<b>6.2</b>	Full Scale Value Setting (FSC).....	13
<b>6.3</b>	Conversion Value of Carbon Monoxide Sensor (nA).....	14
<b>6.4</b>	Gain Factor (Fct).....	15
<b>6.5</b>	Calibration Value.....	15
<b>7.0</b>	Threshold Alarms.....	15
<b>8.0</b>	Powering Off.....	16
<b>9.0</b>	Factory Reset.....	16
<b>10.0</b>	Maintenance.....	17
<b>10.1</b>	Analyzer Care.....	17
<b>10.2</b>	Battery Replacement.....	17
<b>10.3</b>	Sensor Replacement.....	18
<b>10.3.1</b>	Handling Sensors.....	19
<b>11.0</b>	Spares and Accessories.....	19
<b>11.1</b>	Sensor.....	19
<b>11.2</b>	Calibration Equipment.....	19
<b>12.0</b>	Relay Output Schematics.....	20
<b>Appendix</b>		
<b>Analyzer Sensor Specifications</b>	.....	21
<b>Troubleshooting</b>	.....	21
<b>Warranty</b>	.....	22

## 1.0 Introduction

This manual will assist you in the proper set-up, operation and maintenance of the Pro Carbon Monoxide Analyzer with Low Pressure and High Temperature alarms. Be sure to read the entire manual. Improper operation of this unit can cause serious injury or death.

Throughout this manual we will use certain words to call your attention to conditions, practices or techniques that may directly affect your safety. Pay particular attention to information introduced by the following signal words:

### **Danger**

Indicates an imminently hazardous situation which, if not avoided, will result in serious personal injury or death.

### **Warning**

Indicates a potentially hazardous situation, which if not avoided, could result in serious personal injury or death.

### **Caution**

Indicates a potentially hazardous situation, which if not avoided, may result in minor or moderate injury. It may also be used to alert against unsafe practices.

### **Notice**

Notifies people of installation, operation or maintenance information which is important but not hazard-related.

#### Warnings Graphics Defined:



Gas Inhalation



Skin damage

#### Abbreviations commonly used in this manual:

CO	Carbon Monoxide	L/min	Liters Per Minute
CO%	Carbon Monoxide Percentage of Gas	L.P.	Low Pressure
PPM	Parts Per Million	H.P.	High Pressure
psi	Pounds Per Square Inch		

## 2.0 System Description

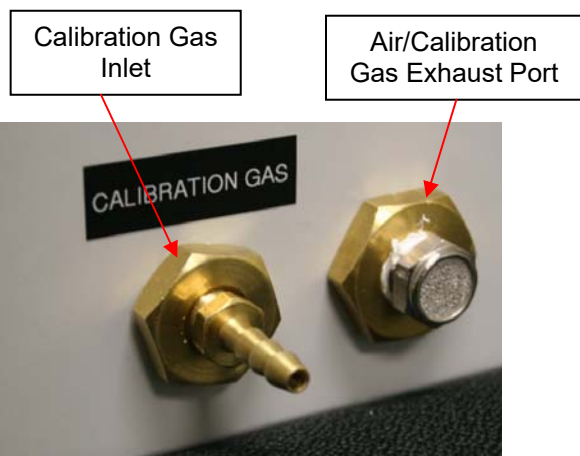
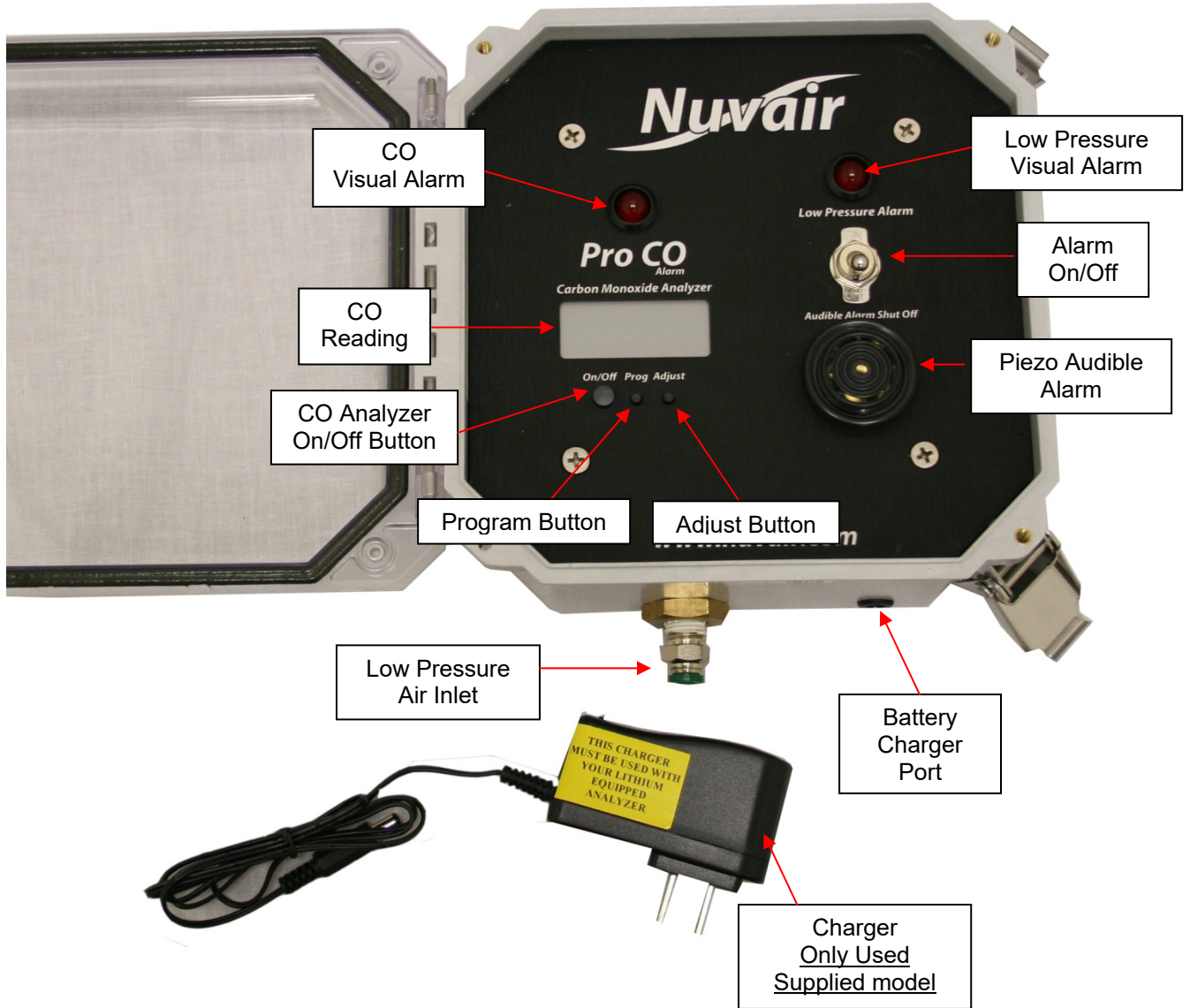

## 2.0 System Description

The Pro CO Carbon Monoxide Analyzer measures carbon monoxide (CO) levels in gases in the range of 0 to 100 parts per million (ppm). It can be used to measure the CO content in gas mixes that may be contaminated due to the introduction of CO from internal combustion engines or other devices where CO is a byproduct. This unit is designed to verify CO concentration in continuous air flow from an operating compressor. In Addition, the unit includes a Low Pressure alarm that will activate if the air pressure supplied to the unit drops below a set value (factory set at 100 PSI). There is an On/Off Switch located on the face of the analyzer that will control the operation of the alarm. This should remain in the "Off" position until the compressor is at operating pressure. The Analyzer housing is a water and impact resistant unit, compatible with outdoor and marine environments.



### **Danger**

**Carbon monoxide is a colorless, odorless, tasteless gas that will not support life. Exposure to carbon monoxide can lead to unconsciousness and death.**

**Do not use this unit as a stand-alone safety monitor. Learn to recognize the effects of CO poisoning.**

The Analyzer is battery powered and includes an internally mounted Sensor with Audible Alarm. The Water-Resistant Case includes a Digital Display and controls that are environmentally sealed

The Analyzer uses a Flow Regulator to deliver sample gas to the Sensor. Pressurized gases must be regulated to avoid damage to the analyzer.

The unit is ready for use after calibration with an appropriate certified calibration gas.



### **Warning**

**This analyzer is designed for use at atmospheric pressures only. It is not designed for exposures in a hyperbaric chamber. Use of this analyzer in a hyperbaric chamber will result in incorrect readings and may damage the unit.**

### **Warning**

**Although the Analyzer is a rugged instrument, careless handling or abuse may result in damage to the Analyzer resulting in inaccurate gas analysis. Inaccurate gas analysis can lead to serious personal injury or death.**

### **Notice**

**Extreme CO exposure levels directed at the Analyzer sensor may damage the sensor. Don't test the sensor in the direct flow of any engine mufflers/exhausts or any other known high concentrations of CO.**



## 2.1. Display

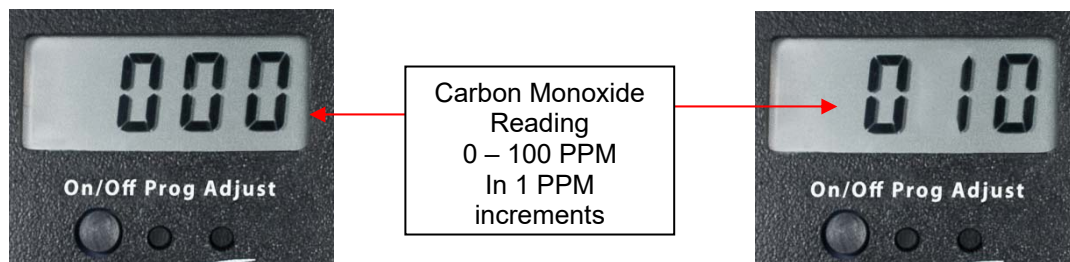

## 2.2. Alarm

The Analyzer includes an audible and visual alarm that is activated when the Sensor reaches factory set 10 PPM CO or user set PPM. The alarm will not clear until the concentration of CO drops below 10 PPM or the user set point. The On/Off switch located on the face of the analyzer controls the High Temp and Low Pressure alarms. It should remain in the “Off” position until the compressor reaches operating pressure.

## 2.3. Sensor

The Analyzer uses an electrochemical CO Sensor to measure CO content in gases. The Sensor is disposable and user-replaceable, with a life expectancy of up to 18 months depending on usage. The Sensor is designed for use at atmospheric pressure (0 psi). The gas mixture to be analyzed must be regulated accordingly, and any potential for pressure or vacuum must be avoided.

## 2.4. Low Pressure Alarm

The Analyzer is equipped with an audible and visual alarm that will activate if air pressure to the analyzer drops below 100 PSI. This is set at the factory and is the highest minimum pressure allowed by this unit.

## 2.5. Battery

The Pro CO with LP uses a rechargeable Lithium Polymer battery. Only use the supplied Nuair 110/230 V charger. A fully charged battery should last up to 24 hours. Recharge takes about 4 hours. Do not leave unit unattended while charging and unplug once charged.

## 2.6. Low Pressure Air Inlet

The Analyzer includes a ¼ Tube push-lock fitting which is used to adapt a sample flow of air from a low pressure compressor.

### 3.0 Installation

The Pro CO LP can be hand held or wall mounted. A sample gas flow must be established after the final control valve or at the gas supply outlet using a push-lock or similar connection to a ¼" nylon tube running to the ¼" push-lock at the bottom of the Pro CO LP Alarm.

### 4.0 Operation

Prior to Analyzer use:

- 1) Turn unit on (hold on/off for more than 3 sec). Once fully cycled, the screen should read "000"



Ready For  
Gas Analyzing

- 2) Cycle through the current settings of the analyzer.
  - a. Hold down the "Prog" button for 2 seconds then use the "On/Off" button to cycle through the 1<sup>st</sup> Alarm Value, 2<sup>nd</sup> Alarm Value, Full Scale Value, Conversion Value of the Sensor, and Gain Factor.
  - b. Adjust Alarm values at this time if needed see **Section 6**
- 3) Check Calibration of Analyzer using "Calibrated Test Gas" on a weekly basis.

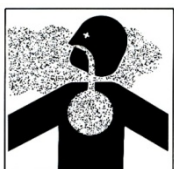

#### **Warning**

Do not test cylinders suspected of containing carbon monoxide in a confined space that does not have good ventilation. Exposure to carbon monoxide can lead to unconsciousness and death.

#### **Warning**

Gas, even under moderate pressures, can cause extreme bodily harm. Never allow any gas stream to be directed at any part of your body.

#### **Warning**

Never expose the sensor to pressures above atmospheric pressure (0 psi) or you may cause damage to the sensor and/or receive false readings. Damaged Sensors will not provide accurate gas analysis. Inaccurate gas analysis can lead to serious personal injury or death.

## Warning

It is very important that the calibration take place at atmospheric pressure (1 bar) and roughly 68° F (20°C) with the surrounding air being clean of CO. Calibration performed in air containing CO, such as aboard a moving boat with diesel exhaust or construction site with diesel engines operating, will affect the calibration.

On a moving boat air flow can trap the engine exhaust in the cabin or open deck area creating a high CO environment that will affect calibration.

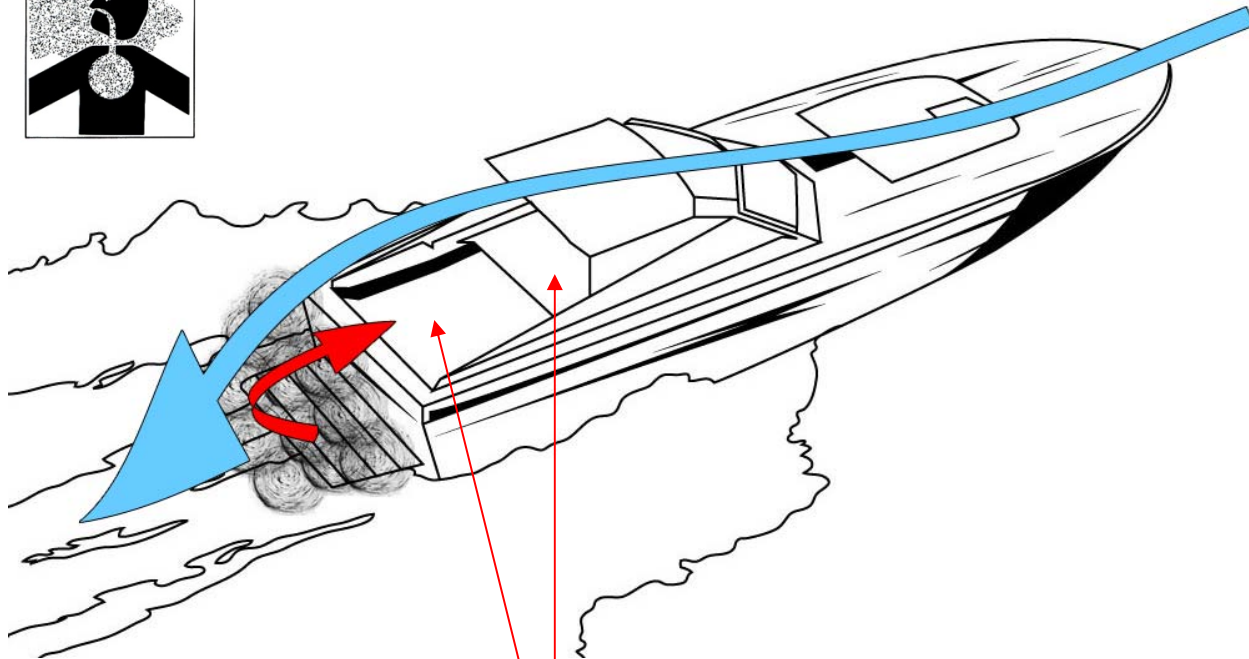

Low pressure areas where CO can be pulled in from boat engine exhaust.

## 5.0 Calibration

### Warning

Analyzer calibration must be verified on a weekly basis. Improper calibration may result in an incorrect reading, exposing the user to dangerous levels of carbon monoxide. Exposure to carbon monoxide can lead to unconsciousness and death.

### Warning

This Analyzer must always be checked against a calibration gas and used with gases regulated and supplied at atmospheric pressure (0 psi). Use of gases at higher pressures may result in incorrect readings and may damage the Analyzer. Incorrect readings may expose the user to high levels of carbon monoxide resulting in personal injury or death.

### Warning

Checking Calibration or use of the Analyzer with a low battery may result in inaccurate readings. Inaccurate gas analysis can lead to serious personal injury or death.

### Notice

If the Analyzer has been subjected to a recent change in ambient temperature, allow it to stabilize for two minutes before checking calibration.

The Pro CO LP is only to be used to analyze the flow from a compressor. **A second, calibrated CO analyzer should be used to confirm the reading of the Pro CO LP.**

Verify calibration on a weekly basis. Breathing gas applications require the use of a certified CO calibration gas (P/N 1016613) with a 10 PPM concentration. This is available from Nuair. See Spares and Accessories section.

To assure the greatest accuracy for other applications, use the calibration gas concentration closest to the expected concentration in the gas being measured.

- The calibration gas flow rate must equal 1.0 L/min at atmospheric pressure. This is regulated by the flow restrictor on the bottle.

The analyzer box is equipped with 2 inlets; one for flow from the Compressor, and one for flow from a Calibration Gas bottle. The Calibration Gas bottle does not have the pressure required to push gas past the pressure regulator at the “Compressor” inlet, and thus **MUST BE** attached to the “Calibration Gas” port via the supplied hose barb fitting.

Calibration Gas Hose Barb and Plug should only be installed **FINGER TIGHT**.  
**DO NOT** use tools to install the fittings.

This port should remain plugged except during calibration



Replace the plug with the supplied hose barb fitting, and then follow the instructions in section 5.1



### To calibrate the Analyzer Span:

1. Power the unit on and allow it to complete its startup.
2. Hold the Prog button down until the Alarm 1 setting is flashing on the screen.
3. Repeatedly press the On/Off button to cycle through the menu until the screen flashes "CAL"
4. Using the Program and Adjust buttons, set the Cal number to match the exact measurement of CO PPM in the calibration gas to be used.
5. Use the Power button to cycle to the home screen.
6. Attach the calibration gas and ensure that gas flow is 1 L/min.
7. Once the display has settled, you can either confirm that calibration is correct, or that a new calibration must be performed.
8. To calibrate the unit, press and hold the Power and Adjust buttons simultaneously until the display flashes CAL. The unit will now recalibrate to the gas flow based on the value input in the CAL programming screen.
9. If the reading drifts after a calibration has been performed, allow the unit to sit for several minutes while powered on before attempting recalibration.

### To calibrate the Analyzer Zero:

1. Power the unit on and allow it to complete its startup.
2. Attach certified 0 PPM 100% Nitrogen calibration gas and ensure that gas flow is 1 L/min.
3. Press the On/Off and Prog buttons simultaneously and hold until the screen flashes "Cal"
4. When the display returns to reading 000, the zero has been set.

### Nuvair offers CO gas testing kits - see addendum for more information

#### 5.1. Sample Flow Method of Checking Calibration (Preferred)

Step 1. Attach Flexible Tubing to Gas Sample Flow of 0.5 to 1 L/min



Step 2. Verify that Gas is flowing through the tubing

Step 3. Allow 15 Seconds for Display Reading to Stabilize

Step 4. Record Reading while Gas is Flowing



## 6.0 Programming Procedures

Keep the “Pro” button pressed until the display changes to AL 1 and alternate with the 3 digit set value, then release the button.

It is possible to program:

- **AL 1** First alarm point expressed in ppm of Carbon Monoxide concentration
- **AL 2** Second alarm point expressed in ppm of Carbon Monoxide concentration
- **FSC** Value expressed in ppm of Carbon Monoxide concentration corresponding to the current output full scale value (20mA). 4mA always correspond to zero ppm CO concentration.
- **nA** Conversion value of Carbon Monoxide sensor
- **Fct** Gain factor
- **CAL** CO concentration in the calibration test gas to be used

At the end of the programming procedure the display will show “End” and the instrument will display the Carbon Monoxide content in the gas mix or “000” if not attached to a CO gas mix.

Below are the actual screen views of each of the modes.



Program



First Alarm



Second Alarm



Full Scale Value



Conversion Value of Sensor



Gain Factor

### 6.1. Alarm Setting (AL 1 & AI 2)

- 1.) Press the Prog button until the display reads “Pr”, then “AL1”. After a second the display will show the current value of “AL1” CO PPM setting.
- 2.) The blinking digit shows the cursor position.
- 3.) Press the Prog button to increase the value (from 0 to 9)
- 4.) Press the Adjust button to cycle the cursor through the digits.
- 5.) To complete your entry and save the CO PPM value, press the On/Off button. You will then move to the “AL 2” programming view.
- 6.) Repeat steps 3 through 5 to modify and save the “AL 2” CO PPM desired value.
- 7.) Once programming of “AL 2” is complete, press the On/Off button repeatedly until the next desired program page is displayed or the end screen appears.

### 6.2. Full Scale Value Setting (FSC)

On the “FSC” page you can change the analog full scale value. It is not necessary to modify this value unless a new sensor is installed. This is the Carbon Monoxide concentration corresponding to 20 mA on the analog output. 4mA is the value at 0 ppm of Carbon Monoxide. When installing a new sensor, input the “Fsc” value displayed on the new sensor here AND in the “Fct” value.

- 1.) Press and hold the “Prog” button to access the program pages, then release the button.
- 2.) Press the On/Off button to cycle through the settings until you reach the “FSC” view.
- 3.) The blinking digit shows the cursor position.
- 4.) Press the Prog button to increase the value (from 0 to 9)
- 5.) Press the Adjust button to cycle the cursor through the digits.
- 6.) To complete your entry and save the FSC value, press the On/Off button repeatedly until the next desired program page is displayed or the end screen appears.
- 7.) ***This procedure is used ONLY when a new sensor has been ordered from Nuvair and is ready to be installed.***



### 6.3. Conversion Value of Carbon Monoxide Sensor (nA)

The “nA” value is the conversion value of the Carbon Monoxide sensor in nano Ampere. It is not necessary to modify this value except when a new sensor is installed. The new sensor is provided with the new value to be set on this screen.

- 1.) Press and hold the “Prog” button to access the program pages, then release the button.
- 2.) Press the On/Off button to cycle through the settings until you reach the “nA” view.
- 3.) The blinking digit shows the cursor position.
- 4.) Press the Prog button to increase the value (from 0 to 9)
- 5.) Press the Adjust button to cycle the cursor through the digits.
- 6.) To complete your entry and save the nA value, press the On/Off button repeatedly until the next desired program page is displayed or the end screen appears.
- 7.) ***This procedure is used ONLY when a new sensor has been ordered from Nuvair and is ready to be installed.***

### Warning

The conversion value of the Carbon Monoxide sensor is set in factory and must be changed only when the CO sensor is replaced. The new sensor will come from the factory with a label showing the new “nA” value to be programmed. A wrong value of this parameter will give a wrong reading of CO concentration. If it is modified the conversion value of the Carbon Monoxide sensor, the instrument will be no more accurate. All the analysis concentration shown on the display will be wrong. Do not modify this value. It is necessary to modify this value only at the installation of a new sensor. Wrong Carbon Monoxide analysis may lead to death.

#### 6.4. Gain Factor (Fct)

The “Fct” value is the conversion value of gain factor. It is not necessary to modify this value except when a new sensor is installed. The new sensor is provided with the new value to be set on this screen. The value is referred to as the “Fsc” number on the sensor.

- 1.) Press and hold the Prog button to access the program pages, then release the button.
- 2.) Press the On/Off button to cycle through the settings until you reach the “FSC” view.
- 3.) The blinking digit shows the cursor position.
- 4.) Press the Prog button to increase the value (from 0 to 9)
- 5.) Press the Adjust button to cycle the cursor through the digits.
- 6.) To complete your entry and save the Gain Factor value, press the On/Off button repeatedly until the next desired program page is displayed or the end screen appears.
- 7.) ***This procedure is used ONLY when a new sensor has been ordered from Nuvair and is ready to be installed.***

### **Warning**

**Then gain factor is set in factory and must be changed only when the CO sensor is replaced. The new sensor will come from the factory with a label showing the new ‘Fct’ value to be programmed. A wrong value of this parameter will give a wrong reading of CO concentration. If it is modified the gain factor instrument will be no more accurate. All the analysis concentration shown on the display will be wrong. Do not modify this value. It is necessary to modify this value only at the installation of a new sensor. Wrong Carbon Monoxide analysis may lead to death.**

#### 6.5. Calibration Value (CAL)

The “CAL” value corresponds to the CO PPM content of the calibration test gas to be used for calibration

- 1.) Press and hold the Prog button to access the program pages, then release the button.
  - 2.) Press the On/Off button to cycle through the settings until you reach the “FSC” view.
  - 3.) The blinking digit shows the cursor position.
  - 4.) Press the Prog button to increase the value (from 0 to 9)
  - 5.) Press the Adjust button to cycle the cursor through the digits.
- To complete your entry and save the Gain Factor value, press the On/Off button repeatedly until the next desired program page is displayed or the end screen appears.

#### 7.0 Threshold Alarms

Should the Carbon Monoxide reading exceed a threshold alarm (AL1 or AL2), the instrument will go into alarm mode, activating the (optional) relay output (open collector max 100mA) and the internal buzzer. The display will show the trespassed alarm and the actual measured value. To stop the audible alarm, press any key. In this event the Pro Co Analyzer will remain in alarm mode until the analyzed value goes below the alarm. The relay output typically is used to shut down the compressor. Nuvair can supply the necessary components to adapt your compressor to the relay or provide them at the time of install on a new compressor.

## 8.0 Powering Off

At the home or gas reading screen, hold down the On/Off button for a couple of seconds. The Analyzer will display “OFF” and then go blank.



## 9.0 Factory Reset

In case it is necessary to reset the Pro CO Analyzer to the factory settings, power on the Analyzer pressing at the same time for more than one second the “On/Off” and “Adjust” buttons. On the display will appear “res” and the instrument will go to the reading page.

**If you reset the Pro CO Analyzer, you will need to open the unit and get the Full Scale Value (FSC), Conversion Factor (nA), and Gain (Fct) values from the sensor to input into the PRO CO Analyzer before using.**

### **Warning**

In case of reset, the instrument will delete all settings. Before using the instrument, it will be necessary to program the Alarm Values, the Full Scale Value (FSC), the Conversion Value of the Carbon Monoxide sensor (nA), and Gain Factor (Fct). All analyzed concentrations shown will be incorrect if these values are not programmed. Incorrect Carbon Monoxide analysis may lead to death.

## 10.0 Maintenance

### 10.1 Analyzer Care

#### Warning

Analyzers immersed in liquid or stored in wet environments may not operate properly. This may result in incorrect readings. Incorrect gas analysis may result in personal injury or death.

#### Warning

Protect the analyzer from excessive shock and impact. Excessive shock and impact may result in incorrect readings. Incorrect gas analysis may result in personal injury or death.

#### Warning

Protect the analyzer from exposure to hyperbaric environments. Exposure to hyperbaric environments may result in incorrect readings. Incorrect gas analysis may result in personal injury or death.

- Do not clean Analyzer with anything other than a damp soft cloth.
- Do not immerse in liquid, leave unprotected outside, or store in a wet environment.
- Protect Analyzer from excessive shock and impact.
- Protect Analyzer from excessive exposure to sunlight and extreme temperatures.
- Do not use the Analyzer in a hyperbaric environment.

### 10.2 Battery Replacement

#### Notice

Be sure to dispose of spent, leaking, or damaged Battery properly, according to local regulations.

The following pictures illustrate the steps required to replace the batteries in the unit.

**Step 1:** Remove 4 Screws in top plate

**Step 2:** Remove top plate by turning unit over. Be careful of cables attached to plate and box.

**Step 3:** Disconnect plug to battery and remove battery. Replace with Nuvair supplied battery. Any other battery voids warranty and may cause unit to function improperly.

**Step 4:** Replace plate being careful not to pinch cables between top plate and box. Replace all four screws.

**Step 5:** Charge new battery and power on CO analyzer to check for proper operation.

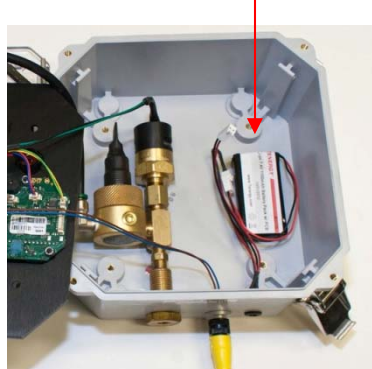

### 10.3 Sensor Replacement

You should take note of your “Fsc” Number and “nA” Number before installing a new sensor. The “Fsc” number is programmed into the Pro CO Analyzer at the “Fct” and “Fsc” setting.

This information will be used to program the Pro CO analyzer after the sensor is installed.



The following pictures illustrate the steps required to replace the Sensor in the Analyzer.

**Step 1:** Remove 4 Screws in top plate



**Step 2:** Remove top plate by turning unit over. Be careful of cables attached to plate and box.

**Step 3:** Disconnect plug to sensor and remove sensor by turning out of flow block. Replace with Nuvair supplied sensor. Any other sensor voids warranty and may cause unit to provide inaccurate CO readings.

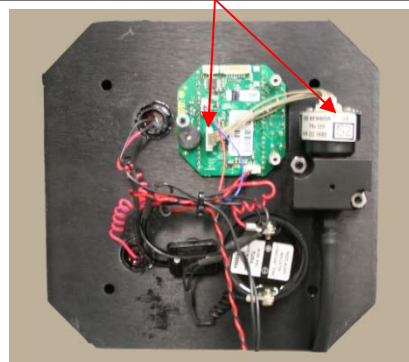

## ⚠ Caution

Be sure to dispose of spent, leaking, or damaged Sensors properly, according to local regulations.

## ⚠ Danger

Do not swallow (ingest) either the electrolyte from the Sensor or the Sensor itself. The Potassium hydroxide chemical contained in the Sensor will cause severe injury or death. If electrolyte or the Sensor is swallowed, seek medical attention immediately.



## ⚠ Warning

If after handling the Analyzer or Sensor, you find that your fingers or other parts of your body feel “slippery” or the skin or eyes sting, immediately flush affected area with clean, fresh water for at least 15 minutes. The stinging or slippery sensation is an indication of a leaking Sensor. The Potassium Hydroxide chemical contained in the Sensor can cause severe injury or death. Seek immediate medical attention if eye contact is made or skin stinging persists.

### 10.3.1 Handling Sensors

Replacement Sensors are supplied in sealed bags. Normally Sensors do not present a health hazard. Before opening the bag, check that the electrolyte has not leaked. If electrolyte leakage has occurred, **DO NOT OPEN BAG**. Dispose of Sensor properly or return for replacement. If electrolyte leakage occurs while the Sensor is in service, use rubber gloves and chemical splash goggles for handling. Rinse contaminated surfaces thoroughly with water.

#### Electrolyte First Aid Procedures

- Ingestion - Drink a large volume of fresh water. Do not induce vomiting. Get immediate medical attention.
- Eye Contact - Flush eyes with clean, fresh water for at least 15 minutes and get medical help immediately.
- Skin Contact - Flush the affected area with clean, fresh water for at least 15 minutes and removed contaminated clothing. If stinging persists get medical attention.

## 11.0 Spares and Accessories

### 11.1 Sensor

Sensor replacement for Pro CO

Part Number: **9501-300 or 9501-50**



### 11.2 Calibration Equipment

Calibration requires certified CO calibration gas to be delivered at a specific flow rate and pressure.

A variety of calibration gas canisters are available from Nuvair, with compatible Flow Restrictor/ Regulator assemblies to regulate the gas.

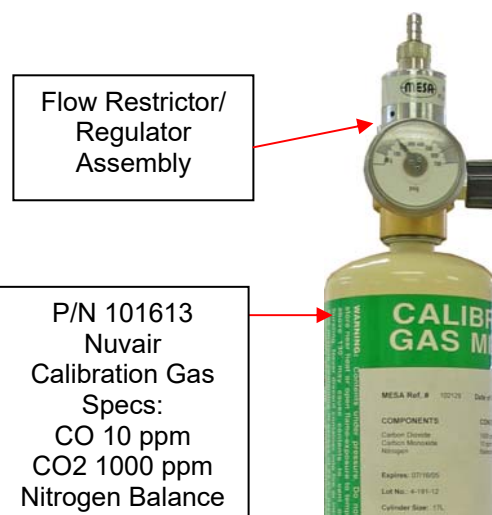

**Testing Gas must NOT contain Helium (He) in order for calibration to succeed.**

## 12.0 Relay Output Schematics

**4-20mA Connections:** The relay output uses a special “Mini Jack” plug that can be purchased separately from Nuvair. Insert the plug into the output jack. Connections diagram below for additional wiring.

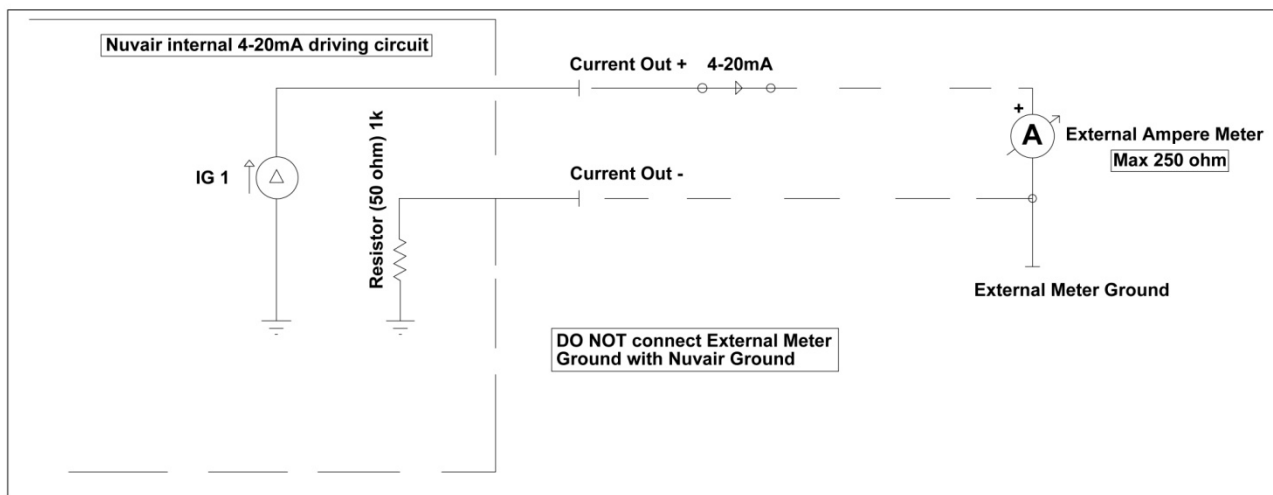

### Warning

The plug should be connected or disconnected when the instrument is switched off, or the instrument will automatically switch off.

### Open Collector Connections:

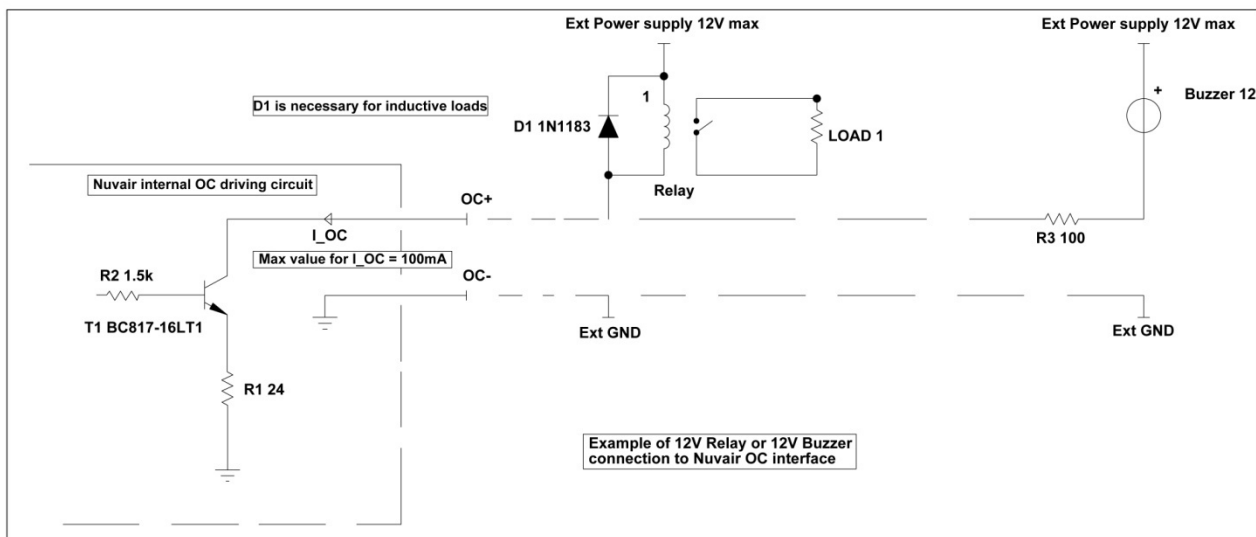

## Appendix

### Analyzer Specifications – Carbon Monoxide Sensor (P/N 9501)

Flow Rate:	0.5-5 L/min
Resolution:	1 ppm
Repeatability:	<±5%
Accuracy:	±5%
Sensor Type:	Electrochemical
Expected Sensor Life:	>24 months in normal use from date of manufacture
Range:	0 – 50 ppm CO (overload up to 300ppm)
Alarm Set Point:	10 ppm CO
Power:	Rechargeable Lithium Ion Battery
Response Time:	Less Than 50 Seconds to 90% of Final Value
Stabilization Time:	15 Minutes when First Installed
Operating Temperature:	14 to 122°F (-10 to 50°C)
Storage Temperature:	14 to 140°F (-10 to 60°C)
Operating Pressure:	Not to Exceed 1 Atmosphere Absolute (0 psi)
Humidity:	15-90% Continuous 0-99% Intermittent
Warranty:	12 Months

Note: All specifications are at ambient / sea level, 77°F / 25°C

## Troubleshooting

SYMPTOM	REASON	SOLUTION
Battery symbol	Low Battery	Change the battery
No display	Switched off Bad connection Low Battery	Switch on Check display/ battery connection Change the battery
Reading erratic	Pressure on sensor Radio transmission Sensor old or faulty Condensation on sensor.	Check flow Move unit away Change sensor Dry in air
Display segments missing	Display faulty	Return to dealer
Reading drifts	Rapid temperature change	Stabilize temperature & recalibrate



## Nuvair Pro CO with Low Pressure Alarm Warranty

Nuvair extends a limited warranty, which warrants the Pro CO LP Alarm to be free from defects in materials and workmanship under normal use and service for a limited period. The Pro CO LP Alarm is warranted according to the terms as set forth below. This warranty is not transferable.

Nuvair will, at its discretion and according to the terms as set forth within, replace or repair any materials which fail under normal use and service and do not exhibit any signs of improper maintenance, misuse, accident, alteration, weather damage, tampering, or use for any other than the intended purpose. Determination of failure is the responsibility of Nuvair, which will work together with the customer to adequately address warranty issues. When any materials are repaired or replaced during the warranty period, they are warranted only for the remainder of the original warranty period. This warranty shall be void and Nuvair shall have no responsibility to repair or replace damaged materials resulting directly or indirectly from the use of repair or replacement parts not approved by Nuvair.

### **Terms:**

Nuvair warrants the Pro CO, LP & HT Alarm to be free from defects in material and workmanship for a period of twelve (12) months from date of purchase. The warranty covers parts and labor.

A warranty registration card, supplied with system documentation, must be filled out and submitted to Nuvair for the warranty to be registered. If the warranty registration card is not received within ten (10) days of purchase, the warranty will begin with the date of manufacture by Nuvair.

### **Maintenance Items:**

Any materials which are consumed, or otherwise rendered not warrantable due to processes applied to them, are considered expendable and are not covered under the terms of this policy. This includes batteries.

### **Return Policy:**

Application for warranty service can be made by contacting Nuvair during regular business hours and requesting a Return Material Authorization number. Materials that are found to be defective must be shipped, freight pre-paid, to the Nuvair office in Oxnard, California. Upon inspection and determination of failure, Nuvair shall exercise its options under the terms of this policy. Warranty serviced materials will be returned to the customer via Nuvair's preferred shipping method, at Nuvair's expense. Any expedited return shipping arrangements to be made at customer's expense must be specified in advance.

### **Limitation of Warranty and Liability:**

Repair, replacement or refund in the manner and within the time provided shall constitute Nuvair's sole liability and the Purchaser's exclusive remedy resulting from any nonconformity or defect. Nuvair shall not in any event be liable for any damages, whether based on contract, warranty, negligence, strict liability or otherwise, including without limitation any consequential, incidental or special damages, arising with respect to the equipment or its failure to operate, even if Nuvair has been advised of the possibility thereof. Nuvair makes no other warranty or representation of any kind, except that of title, and all other warranties, express or implied, including warranties of merchantability and fitness for a particular purpose, are hereby expressly disclaimed. No salesman or other representative of Nuvair has authority to make any warranties.

## Notes





Nuvair  
Phone +1 805 815 4044  
Fax +1 805 486 0900  
1600 Beacon Place  
Oxnard, CA 93036  
USA  
[info@nuvair.com](mailto:info@nuvair.com)  
[www.nuvair.com](http://www.nuvair.com)

Revision 07.18