



User Manual

Pro Trio Analyzer

O₂/CO/CO₂ Analyzer

Rev. 08.22

If you have any questions on this equipment please contact Technical Support at:

Nuvair
1600 Beacon PI
Oxnard, CA 93033

Phone: +1 805 815 4044
Fax: +1 805 486 0900
Email: info@nuvair.com

Hours: Monday through Friday
8:00 AM to 5:00 PM PST USA

Warning

This User Manual contains important safety information and should always be available to those personnel operating this equipment. Read, understand, and retain all instructions before operating this equipment to prevent injury or equipment damage.

Every effort was made to ensure the accuracy of the information contained within this manual; however, we retain the right to modify its contents without notice. If you have problems or questions after reading the manual, stop and call for information.

Warning

Never expose gas sensors to pressure or you may cause damage and/or false readings. Damaged sensors will not provide accurate gas analysis. Most gas analyzers can be used to analyze a regulated gas sample flow, the contents of a gas cylinder, or the flow from a regulator. The flow rate of gas must equal 1-5 L/min. To produce this flow, a Flow Restrictor and Regulator may be required. A faulty Flow Restrictor can lead to a false analyzer reading. Flow Restrictors should be regularly tested with a Flow Meter. Inaccurate gas analysis can lead to serious personal injury or death.

Table of Contents

Introduction5

1.0 System Description6

 1.1 Identification of Analyzer Components.....7

2.0 Individual Specifications of the Analyzers.....9

 2.1 Oxygen Sensor:.....9

 2.1 Carbon Monoxide Sensor:.....9

 2.2 Carbon Dioxide Sensor:.....9

3.0 Requirements for Operation of Analyzer Trio10

 3.1 Gas Flow10

 3.2 AC Power10

 3.3 Gas Sensors.....10

4.0 Calibration.....11

5.0 Operation of Analyzer Trio12

 5.1 Turning on Analyzers:.....12

 5.2 Threshold Alarms.....14

 Each Analyzer has independent threshold alarms that are user programmable.....14

 5.3 Powering off14

 Hold down the On/Off button for a couple of seconds on each of the analyzers in the Analyzer Trio.

 The Analyzer will display “OFF” and then go blank.14

6.0 Factory Reset14

7.0 Maintenance15

 7.1 Analyzer Care.....15

 7.2 Battery Replacement.....16

 7.3 Sensor Replacement.....16

8.0 Programming of the Analyzers in the Analyzer Trio16

9.0 Pro O₂ Alarm Analyzer17

 9.1 Pro O₂ Analyzer Controls18

 9.2 O₂ Analyzer Alarm18

 9.3 O₂ Analyzer Sensor18

 9.4 Pro O₂ Calibration Methods19

 9.5 Pro O₂ Analyzer Operation.....20

 9.6 Programming Procedures.....21

 9.7 Alarm Setting (AL 1 & AI 2)22

 9.8 Full Scale Value Setting (FSC)22

 9.9 Calibration Oxygen Value (O_{2c})22

 9.10 Threshold Alarms.....23

 9.11 Powering on and warming up.....23

 9.12 Powering Off24

 9.13 Factory Reset24

10.0 Pro CO₂ Carbon Dioxide Analyzer24

 10.1 Pro CO₂ Controls25

 10.2 Pro CO₂ Display25

 10.3 Pro CO₂ Alarm26

 10.4 Pro CO₂ Sensor.....26

 10.5 Pro CO₂ Calibration26

 10.6 Pro CO₂ Operation27

10.7	Pro CO ₂ Sample Flow Method of Checking Calibration (Preferred)	28
10.8	Pro CO ₂ Programming Procedures.....	29
10.9	Pro CO ₂ Alarm Setting (AL 1 & AL 2)	30
10.10	Pro CO ₂ Full Scale Value Setting (FSC)	30
10.11	Pro CO ₂ Threshold Alarms	30
10.12	Pro CO ₂ Powering Off.....	31
10.13	Pro CO ₂ Factory Reset.....	31
10.14	Pro CO ₂ Sensor Replacement.....	31
11.0	Pro CO Carbon Monoxide Analyzer.....	32
11.1	Pro CO Analyzer Controls.....	33
11.2	Pro CO Display.....	33
11.3	Pro CO Alarm	33
11.4	Pro CO Sensor	33
11.5	Pro CO Calibration	33
11.6	Pro CO Operation.....	34
11.7	Pro CO Sample Flow Method of Checking Calibration	36
11.8	Pro CO Programming Procedures.....	37
11.9	Pro CO Alarm Setting (AL 1 & Al 2)	38
11.10	Full Scale Value Setting (FSC).....	38
11.11	Conversion Value of Carbon Monoxide Sensor (nA)	38
11.12	Gain Factor (Fct).....	39
11.13	Pro CO Threshold Alarms.....	40
11.14	Powering Off the Pro CO.....	40
11.15	Pro CO Factory Reset	40
11.16	Pro CO Sensor Replacement.....	40
11.17	Handling Pro CO Sensors	41
12.0	Spares and Accessories.....	42
12.1	Calibration Equipment.....	42
12.2	Replacement Sensors.....	42
12.2.1	O ₂ Replacement Sensor P/N 9507	42
12.2.2	CO Replacement Sensor P/N 9501.....	42
12.3	Flow Restrictors and Regulators	43
13.0	Troubleshooting	43
14.0	Relay Output Schematics.....	44

Introduction

This manual will assist you in the proper set-up, operation and maintenance of the Analyzer Trio. Be sure to read the entire manual.

Throughout this manual we will use certain words to call your attention to conditions, practices or techniques that may directly affect your safety. Pay particular attention to information introduced by the following signal words:

Danger

This indicates an imminently hazardous situation, which if not avoided, will result in serious personal injury or death.

Warning

This indicates a potentially hazardous situation, which if not avoided, could result in serious personal injury or death.

Caution

This indicates a potentially hazardous situation, which if not avoided, may result in minor or moderate injury. It may also be used to alert against unsafe practices.

Notice

This notifies people of installation, operation or maintenance information which is important but not hazard-related.

Warnings Graphics Defined:



Gas Inhalation

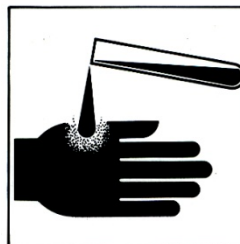

Skin damage

Abbreviations commonly used in this manual:

CO Carbon Monoxide
CO% Carbon Monoxide Percentage of Gas
PPM Parts Per Million
psi Pounds Per Square Inch
HT High Temperature

O₂ Oxygen
LP Low Pressure
HP High Pressure
L/min Liters Per Minute
ATM Atmospheric Pressure

1.0 System Description

The NuVair Analyzer Trio measures Oxygen (O₂), Carbon Dioxide (CO₂), and Carbon Monoxide (CO) levels in supplied gases. All Analyzers are in a water resistant, impact resistant case with a clear cover that allows for viewing of all gas displays, visual alarms and easy access to analyzer controls. This unit is compatible with outdoor and marine environments.

The internal sensors are plumbed together to monitor a single input. Pressurized gases must be regulated down to atmospheric pressure to avoid damage to the analyzer. The sample flow rate must be between 1.0 to 5.0 L/min for an accurate reading.

The Analyzer Trio has visual and optional audible alarms for each of the gases monitored. An audible alarm will sound if any alarm set point is reached.

All analyzers must be calibrated with an appropriate certified calibration gas before operation.

Battery powered units will come equipped with a Lithium battery and dedicated charger. The Lithium battery charger may also be used as a constant power source. If the user chooses to use the charger as a power source for an extended period, it is recommended that the Lithium battery be disconnected from the analyzers to avoid battery damage.

Warning

This analyzer is designed for use at atmospheric pressures only. It is not designed for exposures in a hyperbaric chamber. Use of this analyzer in a hyperbaric chamber will result in incorrect readings and may damage the unit.

Warning

Although the Analyzer is a rugged instrument, careless handling or abuse may result in damage to the Analyzer components resulting in inaccurate gas analysis. Inaccurate gas analysis can lead to serious personal injury or death.

Notice

Extreme Gas exposure levels directed at the Analyzer sensors may damage the sensors.

1.1 Identification of Analyzer Components

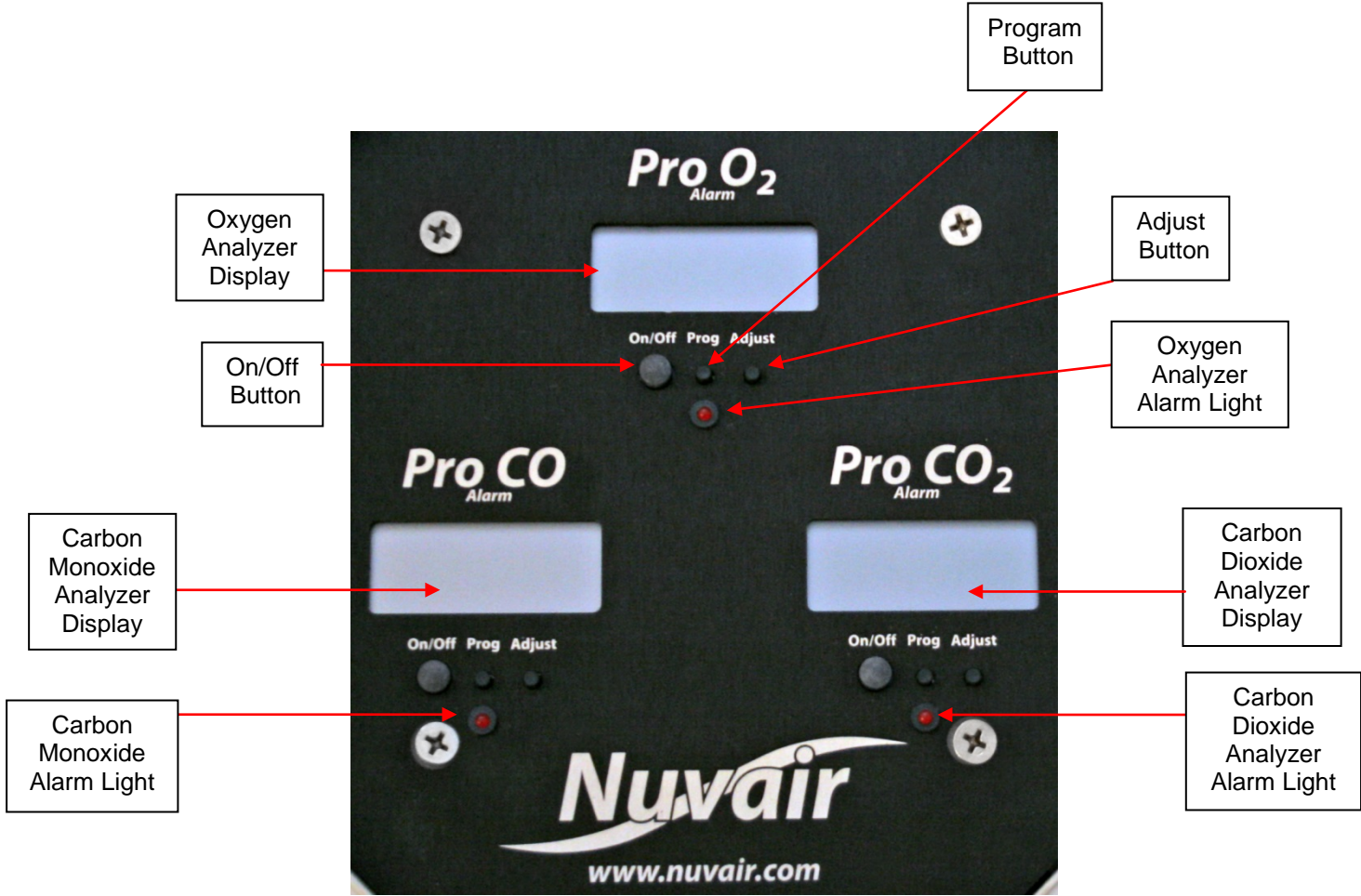

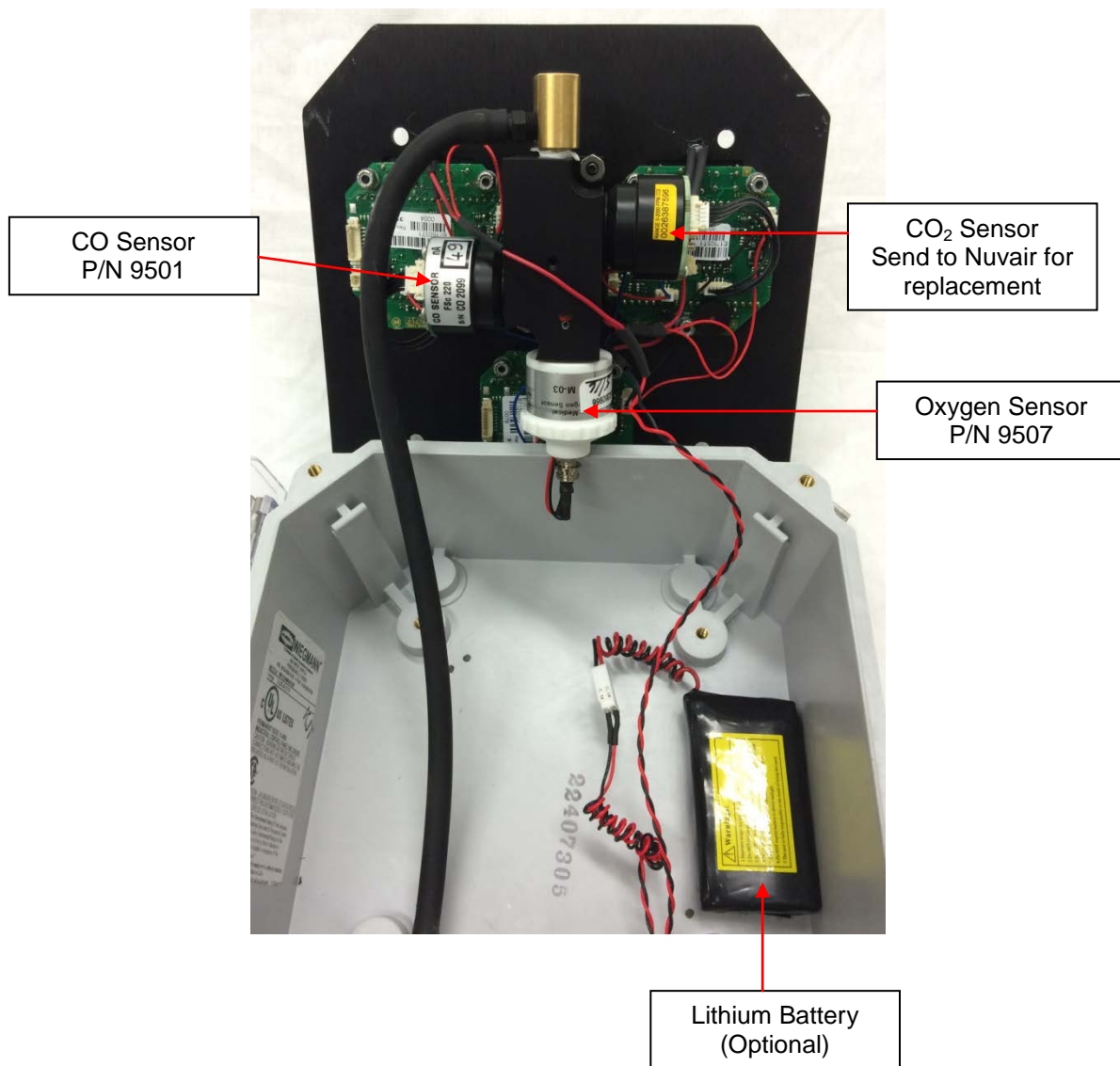

2.0 Individual Specifications of the Analyzers

Note: All specifications are at ambient / sea level, 77°F / 25°C. Decreased accuracy when operated out of range or in inconsistent environmental conditions.

2.1 Oxygen Sensor:

Sensor Type:.....	Electrochemical w/ 3.5mm Molex Jack connect
Expected Sensor Life, Room Air:	3 Years
Range:.....	0 - 100.0% Oxygen (0-1 ATA PPO ₂)
Accuracy:	+/- 1%
Response Time (T90):.....	< 6 Seconds
Drift:	< 1% Volume O ₂ /month @ ATM
Operating Temperature:	32-104°F (0-40°C) <i>Decreased Accuracy when out of range</i>
Storage Temperature:	32-122°F (0 to 50°C)
Linearity Error:	= 2% @ 100% O ₂ applied for 5 min.
Influence of Humidity:.....	-0.03% rel. O ₂ reading/%RH
Operating Pressure:	Not to Exceed One Atmosphere Absolute (0 psi)
Humidity (non-condensing):	up to 99% rh

2.1 Carbon Monoxide Sensor:

Sensor Type:.....	Electrochemical
Expected Sensor Life, Room Air:	2 Years
Range:.....	0 – 50 ppm CO
Accuracy (Resolution):	1 ppm
Response Time (T90):.....	< 50 Seconds
Drift:	<5% per annum
Operating Temperature:	14-122°F (-10-50°C) <i>Decreased Accuracy when out of range</i>
Storage Temperature:.....	14 - 140°F (-10 - 60°C)
Operating Pressure:	Not to Exceed One Atmosphere Absolute (0 psi)
Humidity:.....	15 - 90% Continuous, 0 - 99% Intermittent

2.2 Carbon Dioxide Sensor:

Sensor Type:.....	Non-dispersive Infrared (NDIR)
Expected Sensor Life, Room Air:	5 Years
Range:.....	0 – 2000 ppm CO ₂
Accuracy (Resolution):	1 ppm
Warm Up:	1-10 min +/- 0.2% of range
Response Time (T90):.....	< 30 Seconds (1-10 min Warm up)
Drift:	+/- 1% / month @ 60°C (68°F) ambient
Operating Temperature:	-4-122°F (-20-50°C) <i>Decreased Accuracy when out of range</i>
Storage Temperature:.....	-4-122°F (-20-50°C)
Operating Pressure:	Not to Exceed One Atmosphere Absolute (0 psi)
Humidity:.....	0 to 95% rh, non-condensing

3.0 Requirements for Operation of Analyzer Trio

The Analyzer Trio will require the following connections.

1. Constant gas flow reduced to 1.0 to 5.0 L/min at ATA.
2. Either proper electrical supply to the cord for non-battery units, or 110Volt, 60Hz AC Outlet to power the lithium battery charger if so equipped.

3.1 Gas Flow

Before using the Analyzer Trio you must connect the analyzer to your compressor system by diverting regulated gas to the analyzer. This will require the use of a flow restrictor to reduce the gas to 1.0 – 5.0 L/Min input. NuVair sells 3 L/Min flow restrictors for this purpose. See Spares and Accessories section.



3.2 AC Power

Use the provided AC power supply to plug into 110V power.

For lithium battery powered analyzers, the battery charger may be used as a constant power supply. It is recommended that should the user choose to do this, the lithium battery should be disconnected from the system to avoid damage to the cells.



3.3 Gas Sensors

The Analyzer Trio uses three individual analyzers and sensors to measure content in gases of O₂, CO₂ and CO. The O₂, CO₂ and CO Sensors are disposable and user-replaceable. The life expectancy of the O₂ sensor is 3 years. The life expectancy of the CO sensor is 4 years. The life expectancy of the CO₂ sensor is 5 years. The Sensors are designed for use at atmospheric pressure. The sample gas mixture to be analyzed must be regulated and any potential pressure or vacuum must be avoided. Vibration, oil, moisture and particles (contamination) will shorten the life expectancy of sensors.

4.0 Calibration

Analyzer calibration must be verified on a daily basis. Improper calibration may result in an incorrect reading, delivering inaccurate levels of gas being monitored.

Nuvair offers two gas testing kits for the Analyzer Trio. A Helium free gas is recommended. See addendum for more information.

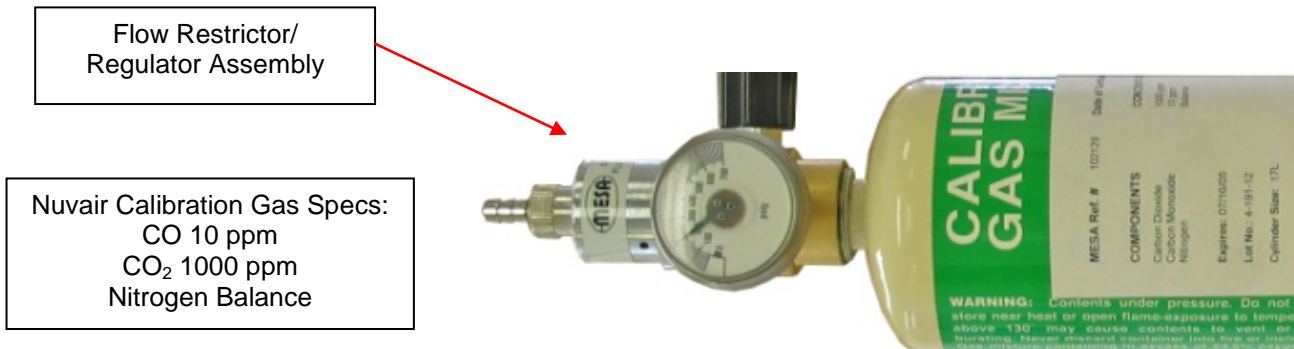

Warning

Analyzer calibration must be verified on a daily basis. Improper calibration may result in an incorrect reading, delivering inaccurate levels of gases or moisture being monitored.

Warning

This Analyzer must always be checked with a calibration gas and used with gases regulated and supplied at atmospheric pressure (0 psi). Use of gases at higher pressures may result in incorrect readings and may damage the Analyzer. Inaccurate gas analysis can lead to serious personal injury or death.

Warning

Checking Calibration or use of the Analyzer with a low battery may result in inaccurate readings. Inaccurate gas analysis can lead to serious personal injury or death.

Notice

If the Analyzer has been subjected to a recent change in ambient temperature, allow it to stabilize for one hour before checking calibration.

Verify calibration on a daily basis. Breathing gas applications require the use of a certified calibration gas with no moisture concentration and flow rate of 1.0-5.0 L/min. The equipment to produce this flow is available from Nuvair. See Spares and Accessories section.

To assure the greatest accuracy for other applications, use the calibration gas concentration closest to the expected concentration in the gas being measured.

5.0 Operation of Analyzer Trio

5.1 Turning on Analyzers:

- 1) Attach a 1.0 to 5.0 L/min flow of ambient air using the battery powered air pump or sample flow from a compressor pumping only ambient air, or calibration gas with a 21% O₂ mixture to the Analyzer Trio. This is necessary for the Pro O₂ Analyzer to calibrate accurately at startup.

If no other method is available, use a short length of neoprene hose attached to the air input to suck air backward across the sensors. This will draw fresh ambient air into the enclosure. DO NOT blow into the tube as expelled breath contains lower oxygen content and will cause improper calibration.



- 2) Turn on each analyzer by holding down the On/Off button until the display shows the startup cycle.
- 3) Monitor for the low battery warning on battery powered units. Turn off the analyzers, plug in the battery charger, and turn the analyzers back on if the battery warning appears.
- 4) Once fully cycled, the screens should display digits.



- 5) The values on the displays will continue to change until they settle on the readings for the current gas. Each of the Analyzers performs independently, and will display data in accordance to their individual readings. User must read and consult the instructions for each analyzer section in this manual to understand responses of each analyzer.
- 6) If verifying calibration, you may now attach the calibration test gas and verify the readings are appropriate for the test gas mix (recommended is 1000ppm CO₂, 10ppm CO, 40% O₂, Nitrogen balance provided by Nuair).
 - a. If the values do not coincide with the test gas mix, refer to individual analyzer instructions for calibration and troubleshooting.

Warning

Gas, even under moderate pressures, can cause extreme bodily harm. Never allow any gas stream to be directed at any part of your body.

Warning

Never expose the sensor to pressures above atmospheric pressure or you may cause damage to the sensor and/or receive false readings. Damaged Sensors will not provide accurate gas analysis. Inaccurate gas analysis can lead to serious personal injury or death.

Warning

It is very important that the calibration take place at atmospheric pressure and with calibrated test gas that has no moisture in it.

5.2 Threshold Alarms

Each Analyzer has independent threshold alarms that are user programmable.

User should confirm that each of the threshold alarms programmed in the analyzers matches the desired value of the gas to be analyzed.

5.3 Powering off

Hold down the On/Off button for a couple of seconds on each of the analyzers in the Analyzer Trio. The Analyzer will display "OFF" and then go blank.

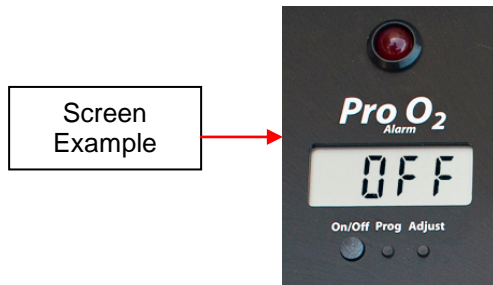

6.0 Factory Reset

In case it is necessary to reset any of the analyzers to their factory settings, follow the instructions outlined in the manual for the specified analyzer.

Warning

Resetting the Analyzer will result in all user programmed alarms and calibration being erased and set at factory defaults.

7.0 Maintenance

7.1 Analyzer Care

Warning

Analyzers immersed in liquid or stored in wet environments may not operate properly. This may result in incorrect readings. Incorrect gas analysis may result in personal injury or death.

Warning

Protect the analyzer from excessive shock and impact. Excessive shock and impact may result in incorrect readings. Incorrect gas analysis may result in personal injury or death.

Warning

Protect the analyzer from exposure to hyperbaric environments. Exposure to hyperbaric environments may result in incorrect readings. Incorrect gas analysis may result in personal injury or death.

- Do not clean Analyzer with anything other than a damp soft cloth.
- Do not immerse in liquid, leave unprotected outside, or store in a wet environment.
- Protect Analyzer from excessive shock and impact.
- Protect Analyzer from excessive exposure to sunlight and extreme temperatures.
- Do not use the Analyzer in a hyperbaric environment.

7.2 Battery Replacement

Notice

Be sure to dispose of spent, leaking, or damaged Battery properly, according to local regulations.

The following pictures illustrate the steps required to replace the batteries in the Analyzer.

1. Unplug battery
2. Pull battery away from housing
3. Replace with Nuair supplied battery.

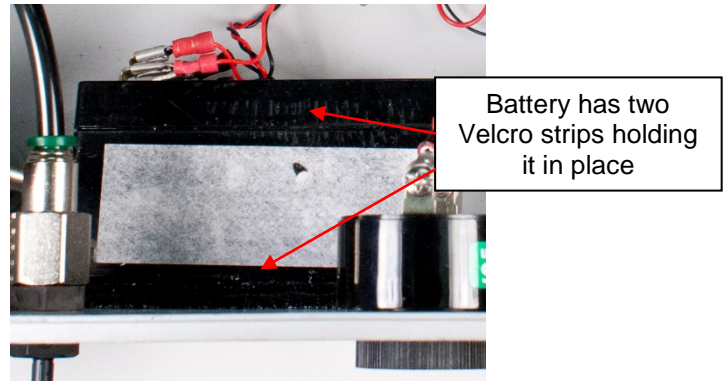

7.3 Sensor Replacement

The Analyzer Trio has two user changeable sensors The O₂ and CO sensors. These sensors have various life expectancies and should be replaced immediately if accuracy is of concern.

The CO₂ sensor is currently not user replaceable and the unit must be shipped to Nuair for service.

If damage occurs, send the analyzer back to Nuair for inspection and Nuair will determine if the unit can be repaired or needs to be replaced.

8.0 Programming of the Analyzers in the Analyzer Trio

The proceeding sections will outline the operation of each of the individual analyzers. There are similarities in how each of the analyzers operate and are programmed. Take extra care in reading the sections especially the alarm settings as each has a different program for tripping the alarms. In some cases the alarms are tripped upon reaching the set value and in others the alarm is tripped until the set value is reached. Refer back to the section associated to the analyzer you are programming whenever possible to confirm the proper alarm settings are being programmed.

9.0 Pro O₂ Alarm Analyzer

The Pro O₂ Alarm Oxygen analyzer measures oxygen (O₂) levels in gases in the range of 0.0 to 100%. The Analyzer is designed to verify O₂ concentration in stored gas cylinders, enclosed spaces and with compressors pumping nitrox. When used in breathing gas applications, redundant Analyzers must be used for verification. In diving, for example, one Analyzer must be used to monitor oxygen during breathing gas production and a second independent Analyzer must be used to verify the oxygen content of the breathing gas prior to diver use.

Warning

When using the Analyzer for diving applications with mixed gases other than air, you must first obtain proper instruction from a certified diving instructor with a nationally recognized training agency qualified in mixed gas diving. Improper use of this analyzer may result in incorrect gas analysis which can lead to serious personal injury or death.

The Analyzer includes an internally mounted Sensor with audible and visual alarms. Large Digital Display and controls are environmentally sealed.

The Analyzer uses a regulated flow of gas within the analyzer to deliver sample gas to the sensor. Pressurized gases must be regulated to avoid damage to the analyzer. Use of this Analyzer in a hyperbaric chamber will void the owner's warranty.

The Analyzer comes in a high impact storage case. It is ready for use after calibration with appropriate certified calibration gases.

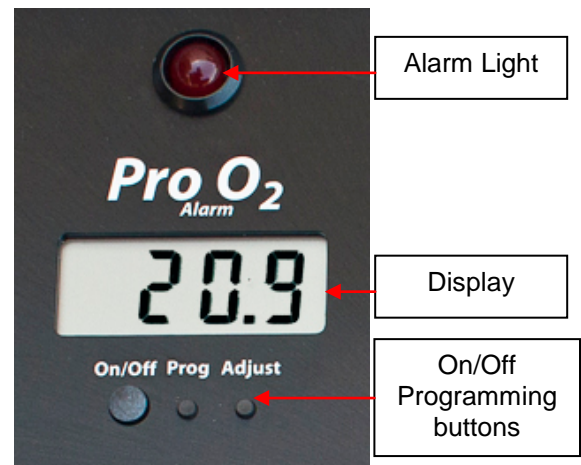

Warning

This analyzer is designed for use at atmospheric pressures only. It is not designed for exposures in a hyperbaric chamber. Use of this analyzer in a hyperbaric chamber will result in incorrect readings and may damage the unit.

Warning

Although the Analyzer is a rugged instrument, careless handling or abuse may result in damage to the Analyzer resulting in inaccurate gas analysis. Inaccurate gas analysis can lead to serious personal injury or death.

Warning

Breathing gas must always be analyzed by two separate Analyzers, with one used for production and one used for analysis after production. Never depend on a single Analyzer during both gas production and delivery. If the Analyzer readings do not agree, both units must be recalibrated. Inaccurate gas analysis can lead to serious personal injury or death.

9.1 Pro O₂ Analyzer Controls

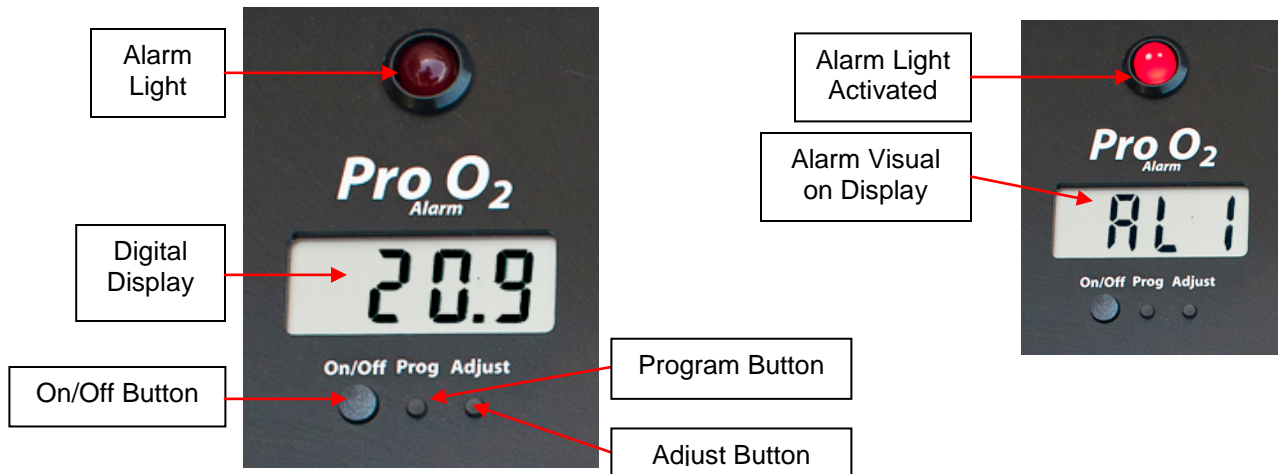

9.1. O₂ Analyzer Display

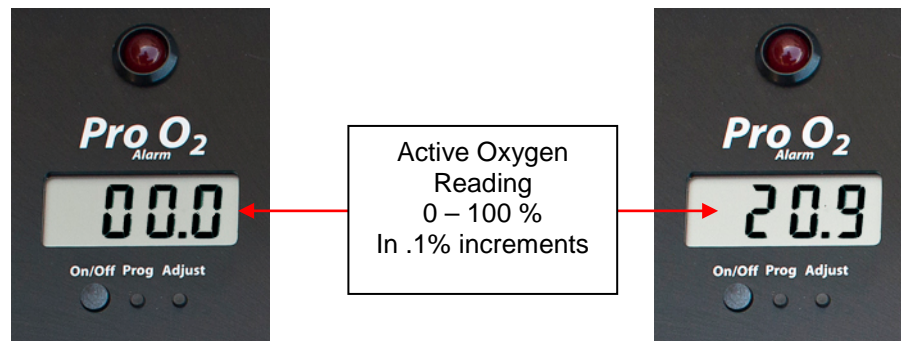

9.2 O₂ Analyzer Alarm

The Analyzer includes an audible alarm that is activated when the sensor reaches a user programmed minimum % of oxygen and maximum % of oxygen. The alarm will not clear until the concentration of O₂ moves into the threshold programmed by the user.

9.3 O₂ Analyzer Sensor

The Analyzer uses an electrochemical O₂ sensor to measure O₂ content in gases. The sensor is disposable and user-replaceable, with a life expectancy of up to 24 months depending on usage. The sensor is designed for use at atmospheric pressure (0 psi). The gas mixture to be analyzed must be regulated accordingly, and any potential for pressure or vacuum must be avoided.

9.2. O₂ Analyzer Calibration

Warning

Oxygen Analyzers must be calibrated before each use. Improper calibration may result in the use of incorrect breathing gas mixtures, which may cause serious injury or death to the person using the gas mixture.

Warning

Calibration or use of the Analyzer with a low battery may result in inaccurate readings. Inaccurate gas analysis can lead to serious personal injury or death.

Warning

When Analyzer calibration is performed at different atmospheric conditions than the gas being measured, a calibration correction value may be required. Improper calibration may result in the use of incorrect breathing gas mixtures, which may cause serious injury or death to the person using the gas mixture.

Notice

If the Analyzer has been subjected to a recent change in ambient temperature, allow it to stabilize for one hour before checking calibration.

Warning

During the warm up time if the oxygen percentage of the mixed gas flow is different from the value of calibration set in the instrument, a failed calibration is obtained and a wrong analysis value will be displayed.

9.4 Pro O₂ Calibration Methods

Calibration should always be performed at the same temperature and humidity conditions as the gas being measured. This is not always possible, for example, in a tropical environment where dry breathing gas from a high-pressure scuba cylinder will be measured after Analyzer calibration has been performed in the warm, humid ambient air. Under these conditions a calibration correction value may be required, or dry air must be used for calibration. It may be required for the analyzer to be auto calibrated to a certified calibration gas.

Warning

Obtain proper training before attempting special calibration procedures. Improper calibration may result in the use of incorrect breathing gas mixtures, which may cause serious injury or death to the person using the gas mixture.

To assure the greatest accuracy for other applications, use the calibration gas concentration closest to the expected concentration in the gas being measured.

9.5 Pro O2 Analyzer Operation

Prior to each Analyzer use:

- 1) Connect the battery powered pump. Before switching on and during the warm up, air must be flowing over sensor for proper calibration. The flow rate of air must equal 1.0 – 5.0 L/min.
- 2) Turn unit on by holding on/off button until display shows “On”, after that the “Att” (Wait) message will be displayed for about 4 seconds, and then the sensor auto-calibration procedure is started.
- 3) The auto-calibration last about 5 seconds; during this time the display will show the message “CAL” and “Att” alternatively. Be sure during this time the sensor is exposed to an air mix with oxygen percentage as programmed in the O2c (calibration) parameter (SEE PROGRAMMING PROCEDURE). By default, for simplicity, the O2c value is set at 21% that corresponds to the percentage of Oxygen in free air.
- 4) At the end of the warm up and calibration, the display will continuously show the oxygen content of the air flow. The instrument is now ready to read oxygen concentration of the gas.

Warning

Gas, even under moderate pressures, can cause extreme bodily harm. Never allow any gas stream to be directed at any part of your body.

Tip: You can check the battery life and current temperature by holding Adjust button for 3 seconds. The display will alternate from battery life to current temperature (Celsius) twice before returning the home screen.

Warning

Never expose the sensor to pressures above atmospheric pressure (0 psi) or you may cause damage to the sensor and/or receive false readings. Damaged Sensors will not provide accurate gas analysis. Inaccurate gas analysis can lead to serious personal injury or death.

9.6 Programming Procedures

Keep the “Pro” button pressed for more than two seconds and then release the button. “Pr” should display for two seconds and then the display will change to AL 1 and alternate with the 3 digit set value.

It is possible to program:

- **AL 1** Minimum alarm point expressed in % of oxygen concentration
- **AL 2** Maximum alarm point expressed in % of oxygen concentration
- **FSC** Value expressed in % of oxygen concentration corresponding to the current output full scale value (20mA). 20mA always correspond to 100 % oxygen concentration.
- **O2c** Oxygen sensor calibration point

At the end of the programming procedure the display will show “End” and the instrument will display the oxygen content of the gas mix.

Below are the actual screen views of each of the modes.

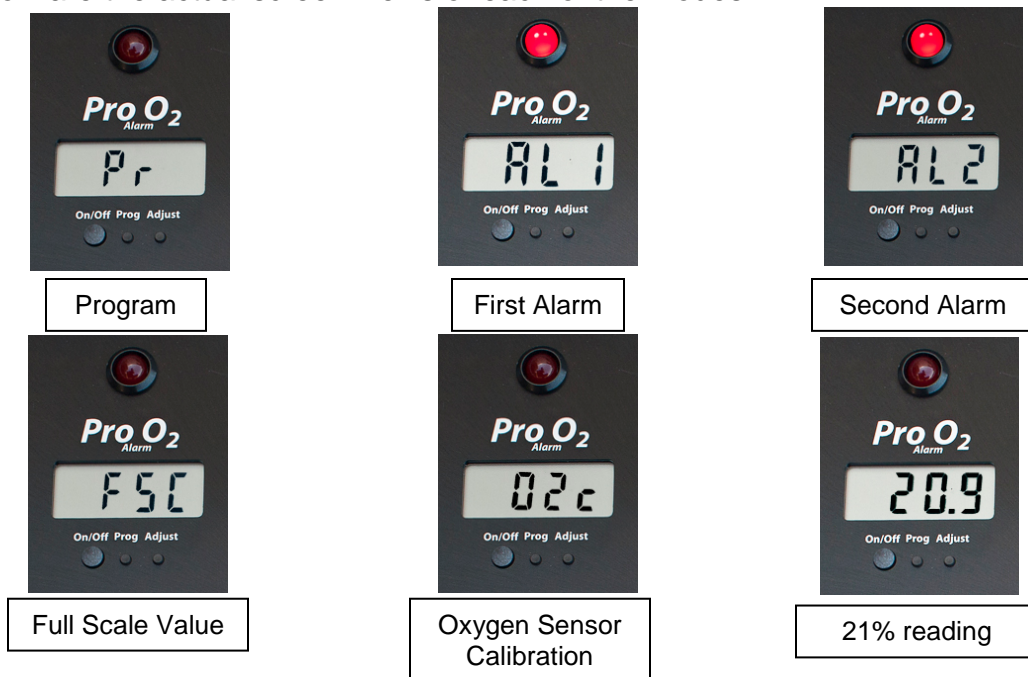

9.7 Alarm Setting (AL 1 & AI 2)

- 1.) Press the “Pro” button for more than two seconds and then release the button. On the display will appear “Pr” for two seconds, then “AL1” will appear and be ready for changing the value of the first alarm point. After a second the display will show the value of “AL1” O₂% (0% default) current setting.
- 2.) The blinking digit shows the cursor position.
- 3.) Press the “Pro” button to increase the value (from 0 to 9)
- 4.) Press the “Adjust” button to move the cursor to the next digit, the “Adjust” button will be used to cycle through the rest of the digits.
- 5.) To complete your entry and save the O₂% value, press the “On/Off” button. You will then automatically jump to “AL 2” programming view.
- 6.) Repeat steps 3 through 5 to modify and save the “AL 2” O₂% desired value (100% default).
- 7.) Once programming of “AL 2” is complete you will be in the “FSC” Value Screen and ready for programming this value. To jump to the end continue to press the “On/Off” button until the end screen appears.

9.8 Full Scale Value Setting (FSC)

Once the alarms have been set the Pro O₂ Alarm Analyzer goes to “FSC” view so that you can change the analog full scale value. It is not necessary to modify this value which is factory set at 100. This is the Oxygen concentration corresponding to 20 mA on the analog output. 4mA is the value at 0% of Oxygen. This value can be changed in the same manner as the Alarm settings:

- 1.) Press the “Pro” button for more than two seconds and then release the button. On the display will appear “Pr” for two seconds, then “AL 1” will appear. Press the On/Off button to cycle through the Alarm settings until you reach the “FSC” view. The “FSC” screen and a 3 digit value will alternate for a few seconds and the Pro O₂ Alarm Analyzer will be ready for adjusting the “FSC” Value.
- 2.) The blinking digit shows the cursor position.
- 3.) Press the “Pro” button to increase the value (from 0 to 9)
- 4.) Press the “Adjust” button to move the cursor to the next digit, the “Adjust” button will be used to cycle through the rest of the digits.
- 5.) To complete your entry and save the FSC value, press the “On/Off” button. You will then automatically jump to “O2c” programming view. To continue pass this to the end press the On/Off button until the “End” screen appears.

9.9 Calibration Oxygen Value (O2c)

After the “O2c” is set the Pro O₂ Alarm Analyzer goes to “O2c”, this is the current Oxygen calibration value default is 21%. It is not necessary to modify this value. The display alternates between “O2c” and the current value (21% default).

Press the “Pro” button for more than two seconds and then release the button.

On the display will appear “Pr” for two seconds, then “AL 1” will appear. Use the On/Off button to cycle through the various settings until you reach the “O2c” screen. The 3 digit value will alternate with the “O2c” screen for a few seconds and the Pro O₂ Alarm Analyzer will be ready for adjusting the “O2c” Value.

- 1.) The blinking digit shows the cursor position.
- 2.) Press the “Pro” button to increase the value (from 0 to 9)
- 3.) Press the “Adjust” button to move the cursor to the next digit, the “Adjust” button will be used to cycle through the rest of the digits.
- 4.) To complete your entry and save the O2c value, press the “On/Off” button. You will then automatically jump to the “End” screen.

 **Warning**

The oxygen calibration value will be the same value of the calibration set when the instrument is switched on. During the warm up time if the oxygen percentage of the gas flowing across the sensor is a different value of calibration set in the instrument, a failed calibration is obtained and the wrong gas percentage will be displayed. Wrong oxygen analysis may lead to death.

 **Warning**

The calibration value of the Pro O₂ alarm is factory set at 21% and any adjustments to this value will change the analyzers ability to properly ready the % of oxygen in a gas. A wrong value in this parameter will give a wrong reading of O₂ concentration and the instrument will not be accurate. All the analysis concentration shown on the display will be wrong. If you modify this setting you must test the analyzer for accuracy with certified testing gas. Do not modify this value. Wrong oxygen analysis may lead to death.

9.10 Threshold Alarms

Should the Oxygen reading go over the threshold alarms (AL1 or AL2) the instrument will go into alarm mode and will activate the (optional) relays output (open collector max 100mA) and the internal buzzer. The display will show the trespassed alarm and the actual measured value. To stop the audible alarm, press any key. In this event the Pro O₂ alarm Analyzer will remain in alarm mode until the analyzed value goes below the alarm.

The relay output typically is used to shut down the compressor. Nuvaair can supply the necessary components to adapt your compressor to the relay or provide them at the time of install on a new compressor.

9.11 Powering on and warming up

Press the On/Off button for more than one second, until the display shows “on”, after that the “Att” (wait) message will be displayed for about 4 seconds, then the sensor auto-calibration lasts about 5 seconds; during this time the display will show the messages “CAL” and “Att” alternatively.

Be sure that during this time the sensor is exposed to the gas mix with the oxygen percentage as programmed in the “O2c” parameter (see programming procedure). By default the parameter is set at 21% by default that corresponds to the percentage of oxygen in free air, be sure that the air flow at this time across the sensor is 21% oxygen before turning on the analyzer.

 **Warning**

During the warm up time if the oxygen percentage of the gas flowing across the sensor is a different value of calibration set in the instrument, a failed calibration is obtained and the wrong gas percentage will be displayed. Wrong oxygen analysis may lead to death.

9.12 Powering Off

At the home or gas reading screen, hold down the On/Off button for a couple of seconds. The Analyzer will display “OFF” and then go blank.



9.13 Factory Reset

In case it is necessary to reset the Pro O₂ Alarm Analyzer to the factory settings, power on the Analyzer pressing at the same time for more than one second the “On/Off” and “Adjust” buttons. On the display will appear “res” and the instrument will go to the reading page.

⚠ Warning

In case of reset, the instrument will delete all the alarms settings, the full scale value, and any new conversion value of Oxygen sensor will be reset to factory settings. Before using again the instrument, it may be necessary to program again the alarm values, the full scale value, and the Oxygen sensor calibration if changed. All the analysis concentration shown on the display would be wrong. Wrong Oxygen analysis may lead to death.

⚠ Warning

Resetting the Analyzer will result in all user programmed alarms and calibration being erased and set at factory defaults.

10.0 Pro O₂ Carbon Dioxide Analyzer

The Pro CO₂ Carbon Dioxide Analyzer measures Carbon Dioxide (CO₂) levels in gases in the range of 0 to 2000 parts per million (ppm). It can be used to measure the CO₂ content in all breathing gas mixes. The Analyzer is designed to verify CO₂ concentration in stored gas cylinders as well as to monitor continuous flow of sample gas from a compressor.

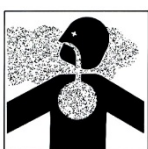

⚠ Danger

Carbon Dioxide is a colorless, odorless, tasteless gas that will not support life. Exposure to Carbon Dioxide can lead to unconsciousness and death.

The Analyzer includes an internally mounted Sensor with audible and visual alarms. Large Digital Display and controls are environmentally sealed.

The Analyzer uses regulated flow within the analyzer to deliver sample gas to the sensor. Pressurized gases must be regulated to avoid damage to the analyzer. Use of this Analyzer in a hyperbaric chamber will void the owner’s warranty.

The Analyzer comes in a high impact storage case. It is ready for use after calibration with an appropriate certified calibration gas.

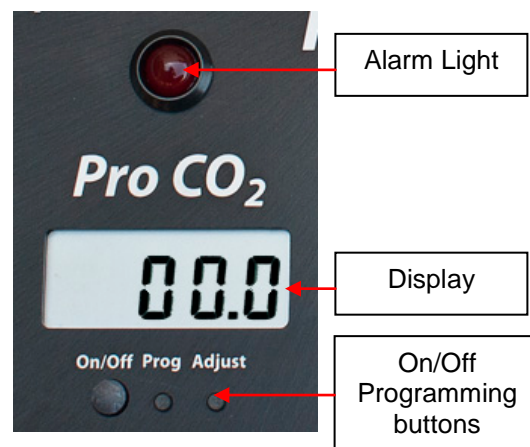

Warning

This analyzer is designed for use at atmospheric pressures only. It is not designed for exposures in a hyperbaric chamber. Use of this analyzer in a hyperbaric chamber will result in incorrect readings and may damage the unit.

Warning

Although the Analyzer is a rugged instrument, careless handling or abuse may result in damage to the Analyzer resulting in inaccurate gas analysis. Inaccurate gas analysis can lead to serious personal injury or death.

Notice

High gas flow directed at the CO₂ Analyzer sensor may damage the sensor.

10.1 Pro CO₂ Controls

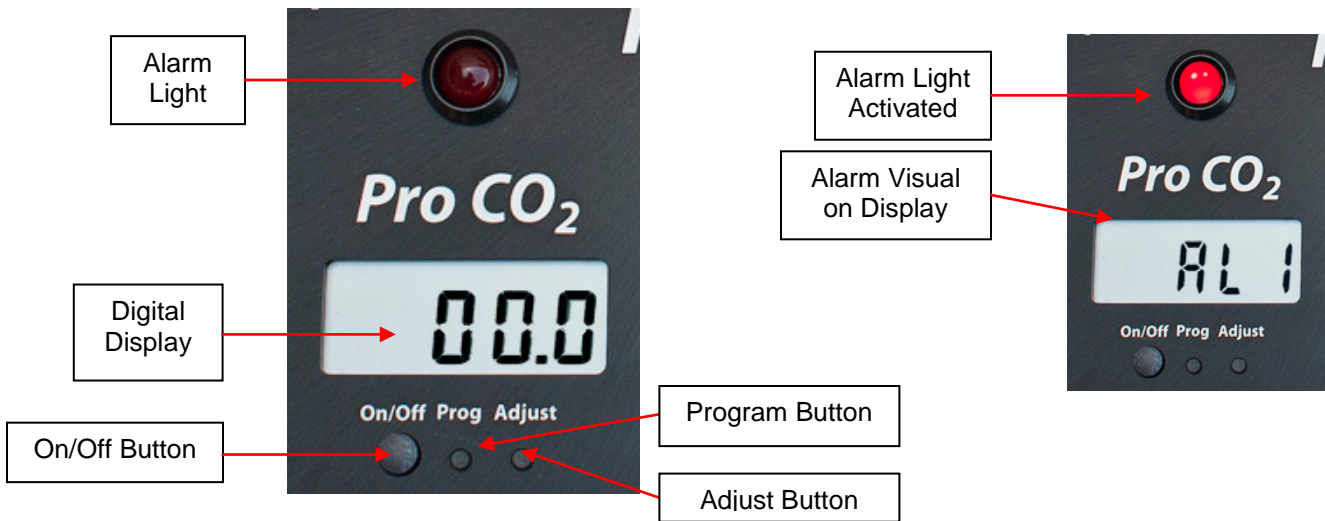

10.2 Pro CO₂ Display

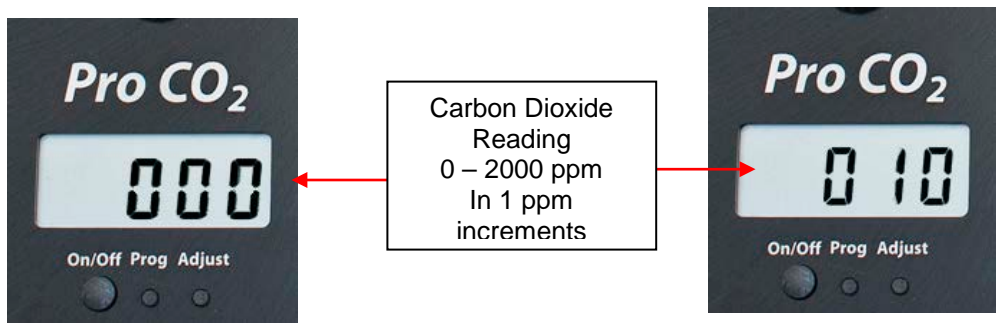

10.3 Pro CO₂ Alarm

The Analyzer includes an audible alarm that is activated when the Sensor reaches 199 ppm CO₂ or user programmed level. The alarm will not clear until the concentration of CO₂ drops below user programmed level.

10.4 Pro CO₂ Sensor

The Analyzer uses an NDIR “non-dispersive infra red” CO₂ Sensor to measure CO₂ content in gases. The Sensor is only replaceable by the factory, so the unit must be shipped to NuVair for service. The Sensor is designed for use at atmospheric pressure (0 psi). The gas mixture to be analyzed must be regulated accordingly, and any potential for pressure or vacuum must be avoided.

10.5 Pro CO₂ Calibration

Warning

Analyzer calibration must be verified on a weekly basis or when moisture and or temperature swings take place. Improper calibration may result in an incorrect reading, exposing the user to dangerous levels of Carbon Dioxide. Exposure to Carbon Dioxide can lead to unconsciousness and death.

Warning

This Analyzer must always be checked against a calibration gas and used with gases regulated and supplied at atmospheric pressure (0 psi). Use of gases at higher pressures may result in incorrect readings and may damage the Analyzer. Incorrect readings may expose the user to high levels of Carbon Dioxide resulting in personal injury or death.

Warning

Checking Calibration or use of the Analyzer with a low battery may result in inaccurate readings. Inaccurate gas analysis can lead to serious personal injury or death.

Notice

If the Analyzer has been subjected to a recent change in ambient temperature, allow it to stabilize for one hour before checking calibration.

Verify calibration on a weekly basis or when the ambient temperature or moisture changes dramatically. Breathing gas applications require the use of a certified CO₂ calibration gas and flow rate of 1.0-5.0 L/min. The equipment to produce this flow is available from NuVair. See Spares and Accessories section.

To assure the greatest accuracy for other applications, use the calibration gas concentration closest to the expected concentration in the gas being measured.

10.6 Pro CO₂ Operation

Prior to each Analyzer use:

Turn unit on (hold on/off for 3 sec) and monitor Display for low battery warning. Replace battery immediately if warning appears. The display will count down from 29 PPM to Att and then display the current CO₂ level sensed by the analyzer sensor.



Cycle through the current settings of the analyzer:

- Hold down the “Prog” button for 2 seconds then use the “On/Off” button to cycle through the low Alarm Value, high Alarm Value, Full Scale Value and end.
- Adjust Alarm values at this time if needed see “11.9. Pro CO₂ Alarm Settings”

Check Calibration of Analyzer using “Calibrated Test Gas”

Tip: You can check the battery life and current temperature by holding Adjust button for 3 seconds. The display will alternate from battery life to current temperature (Celsius) twice before returning the home screen.



Warning

Do not test cylinders suspected of containing carbon dioxide in a confined space that does not have good ventilation. Exposure to carbon dioxide can lead to unconsciousness and death.

Warning

Gas, even under moderate pressures, can cause extreme bodily harm. Never allow any gas stream to be directed at any part of your body.

Warning

Never expose the sensor to pressures above atmospheric pressure (0 P.S.I.) or you may cause damage to the sensor and/or receive false readings. Damaged Sensors will not provide accurate gas analysis. Inaccurate gas analysis can lead to serious personal injury or death.

The Pro CO₂ can be used to monitor an enclosed space or to analyze a regulated gas sample flow, the contents of a gas cylinder, or the flow from a regulator:

- If monitoring an enclosed space, simply remove the Flow Adapter Cap to expose the Sensor face to the atmosphere and allow 15 seconds for the Display reading to stabilize.
- If analyzing a gas flow, the Sample Flow Method is the preferred method. The flow rate must equal 1.0-5.0 L/min at atmospheric pressure (1 bar). To produce this flow, a Flow Restrictor and Regulator may be required. Contact Nuvair if you need assistance.

10.7 Pro CO₂ Sample Flow Method of Checking Calibration (Preferred)

- 1) Turn on Analyzer with air only flowing through the Analyzer Trio. Once the analyzer has stabilized you can move on to step 2.
- 2) Turn the Analyzer off.
- 3) Attach a Certified calibration gas that best matches The gas you will be using with the Analyzer Trio and Open gas line to send a 1.0-5.0 L/min flow to the sensor.
- 4) Turn on the Analyzer and allow reading to stabilize. Record reading and compare to test gas spec.



Once testing is complete and calibration is verified you are able to proceed with using the analyzer.

Nuvair offers CO₂ gas testing kits see addendum for more information.

Testing Gas must not contain Helium for calibration to succeed.

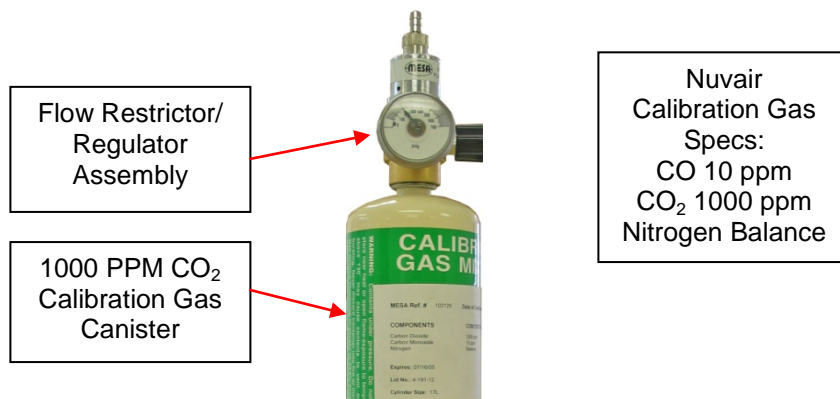

10.8 Pro CO₂ Programming Procedures

Keep the “Prog” button pressed for more than two seconds and then release the button. “Pr” should display for two seconds and then the display will change to AL 1 and alternate with the 3 digit set value.

It is possible to program:

- **AL 1** Low alarm point expressed in ppm of Carbon Dioxide concentration
- **AL 2** High alarm point expressed in ppm of Carbon Dioxide concentration
- **FSC** Value expressed in ppm of Carbon Dioxide concentration corresponding to the current output full scale value (20mA). 4mA always correspond to 1999 ppm CO₂ concentration.

At the end of the programming procedure the display will show “End” and the instrument will display the Carbon Dioxide content in the gas mix.

Below are the actual screen views of each of the modes. (*Calib button say as adjust)



Program



Low Alarm



High Alarm



Full Scale Value



End

10.9 Pro CO₂ Alarm Setting (AL 1 & AL 2)

- 1.) Press the “Prog” button for more than two seconds and then release the button.
On the display will appear “Pr” for two seconds, then “AL1” will appear and be ready for changing the value of the low alarm point. After a second the display will show the value of “AL1” CO₂ ppm current setting.
- 2.) The blinking digit shows the cursor position.
- 3.) Press the “Prog” button to increase the value (from 0 to 9)
- 4.) Press the “Adjust” button to move the cursor to the next digit, the “Adjust” button will be used to cycle through the rest of the digits.
- 5.) To complete your entry and save the CO₂ ppm value, press the “On/Off” button. You will then automatically jump to “AL 2” programming view.
- 6.) Repeat steps 3 through 5 to modify and save the “AL 2” high alarm CO₂ ppm desired value.
- 7.) Once programming of “AL 2” is complete you will be in the “FSC” Value Screen and ready for programming this value. To jump to the end continue to press the “On/Off” button until the end screen appears.

10.10 Pro CO₂ Full Scale Value Setting (FSC)

Once the alarms have been set the Pro CO₂ Analyzer goes to “FSC” view so that you can change the analog full scale value. It is not necessary to modify this value which is factory set at 1999. However if installing a new sensor the value on the sensor can be entered into the “Fsc” setting and must be entered into the “Fct” setting. This is the Carbon Dioxide concentration corresponding to 20 mA on the analog output. 4mA is the value at 1999 ppm of Carbon Dioxide. This value can be changed in the same manner as the Alarm settings:

- 1.) Press the “Prog” button for more than two seconds and then release the button.
On the display will appear “Pr” for two seconds, then “AL 1” will appear. Press the On/Off button to cycle through the Alarm settings until you reach the “FSC” view. The “FSC” screen and a 3 digit value will alternate for a few seconds and the Pro CO₂ Analyzer will be ready for adjusting the “FSC” Value.
- 2.) The blinking digit shows the cursor position.
- 3.) Press the “Prog” button to increase the value (from 0 to 9) (0-19 on the third value)
- 4.) Press the “Adjust” button to move the cursor to the next digit, the “Adjust” button will be used to cycle through the rest of the digits.
- 5.) To complete your entry and save the FSC value, press the “On/Off” button. You will then automatically jump to “End” programming view.

10.11 Pro CO₂ Threshold Alarms

The CO₂ analyzer will alarm until it has reached the AL1 (low) set point if the AL1 has been set. Once the gas is above the AL1 set point the analyzer will not alarm until the gas value is over AL2 or under AL1 during the gas analysis. Should the Carbon Dioxide gas trip the low or high alarms (AL1 or AL2) the instrument will go into alarm mode and will activate the (optional) relays output (open collector max 100mA) and the internal buzzer. The display will show the trespassed alarm and the actual measured value. To stop the audible alarm, press any key. In this event the Pro CO₂ Analyzer will remain in alarm mode until the analyzed value reads between the AL1 and AL2 set points.

The relay output typically is used to shut down the compressor. Nuvaair can supply the necessary components to adapt your compressor to the relay or provide them at the time of install on a new compressor.

10.12 Pro CO₂ Powering Off

At the home or gas reading screen, hold down the On/Off button for a couple of seconds. The Analyzer will display “OFF” and then go blank.



10.13 Pro CO₂ Factory Reset

In case it is necessary to reset the Pro CO₂ Analyzer to the factory settings, power on the Analyzer by pressing the “On/Off” and “Adjust” buttons at the same time. On the display will appear “res” and the instrument will go to the reading page.

Warning

In case of reset, the instrument will delete all the alarms settings and the full scale value. Before using again the instrument, it may be necessary to program again the alarm values and the full scale value. All the analysis concentration shown on the display could be wrong. Wrong Carbon Dioxide analysis may lead to death. You should calibrate your analyzer immediately after a reset before using.

10.14 Pro CO₂ Sensor Replacement

The sensor is not user replaceable. The unit must be shipped to Nuair for service.

11.0 Pro CO Carbon Monoxide Analyzer

The Pro CO Carbon Monoxide Analyzer measures carbon monoxide (CO) levels in gases in the range of 0 to 100 parts per million (ppm). Common uses for a CO analyzer are to measure for CO contamination introduced into gas mixes from internal combustion engines or other devices where CO is a byproduct. The Analyzer is designed to verify CO concentration in stored gas cylinders and in the gas flow from a compressor.



Danger

Carbon monoxide is a colorless, odorless, tasteless gas that will not support life. Exposure to carbon monoxide can lead to unconsciousness and death.

This analyzer utilizes an environmentally-sealed internal sensor that samples gases passing through the input. The operator is notified by the digital display and the audible and visual alarms.

A gas flow is required to deliver sample gas to the sensor. Pressurized gases must be regulated to avoid damage to the analyzer. Use of this analyzer in a hyperbaric chamber will void the owner's warranty.

The Analyzer is ready for use after calibration with an appropriate certified calibration gas.

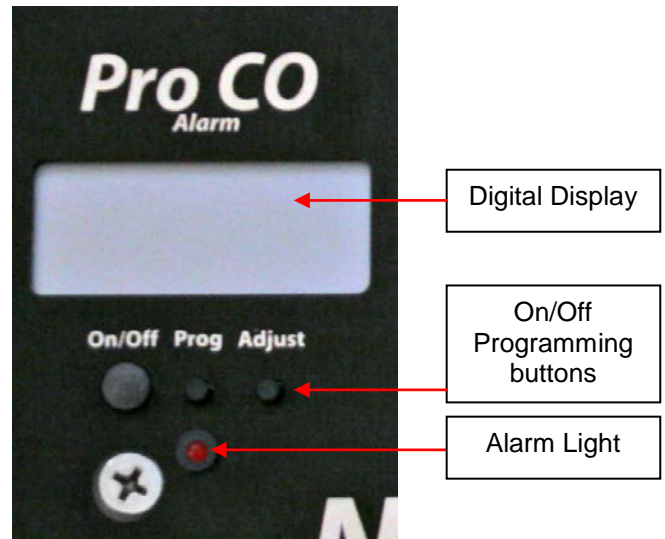

Warning

This analyzer is designed for use at atmospheric pressures only. It is not designed for exposures in a hyperbaric chamber. Use of this analyzer in a hyperbaric chamber will result in incorrect readings and may damage the unit.

Warning

Although the Analyzer is a rugged instrument, careless handling or abuse may result in damage to the Analyzer resulting in inaccurate gas analysis. Inaccurate gas analysis can lead to serious personal injury or death.

Notice

Extreme CO exposure levels directed at the Analyzer sensor may damage the sensor. Don't test the sensor in the direct flow of any engine mufflers/exhausts or any other known high concentrations of CO.

11.1 Pro CO Analyzer Controls

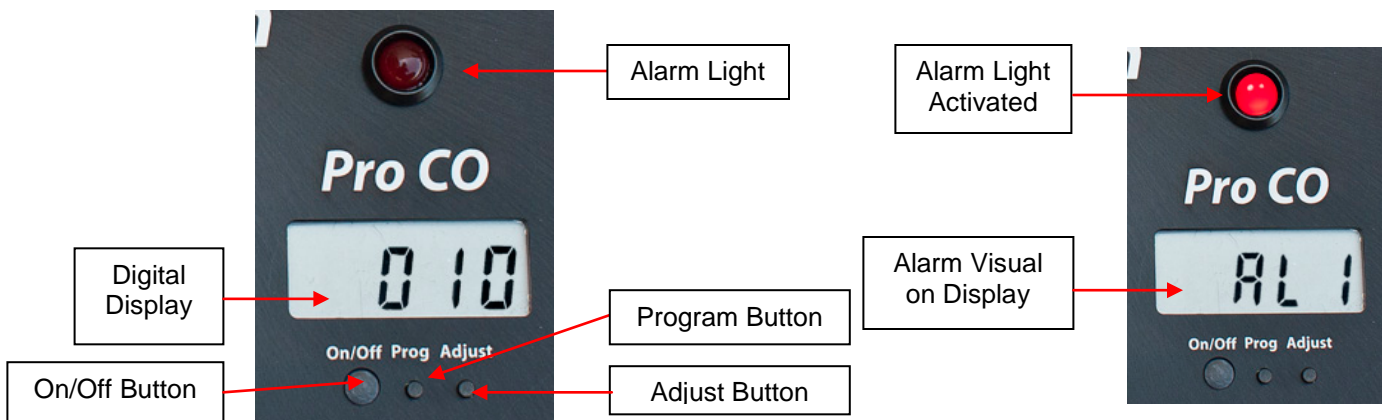

11.2 Pro CO Display

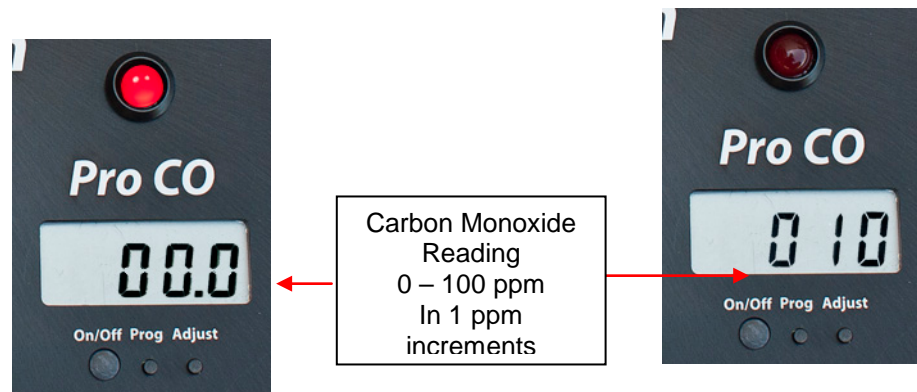

11.3 Pro CO Alarm

The Analyzer includes an audible alarm that is activated when the Sensor reaches 10 ppm CO or user programmed level. The alarm will not clear until the concentration of CO drops below 10 ppm or user programmed level.

11.4 Pro CO Sensor

The Analyzer uses an electrochemical CO Sensor to measure CO content in gases. The Sensor is disposable and user-replaceable, with a life expectancy of up to 24 months depending on usage. The Sensor is designed for use at atmospheric pressure (0 psi). The gas mixture to be analyzed must be regulated accordingly, and any potential for pressure or vacuum must be avoided.

11.5 Pro CO Calibration

Verify calibration on a weekly basis, or when the ambient temperature or moisture changes dramatically. Breathing gas applications require the use of a certified CO calibration gas and flow rate of 1.0-5.0 L/min. The equipment to produce this flow is available from Nuvaair. See Spares and Accessories section.

To assure the greatest accuracy for other applications, use the calibration gas concentration closest to the expected concentration in the gas being measured.

Warning

Analyzer calibration must be verified on a weekly basis. Improper calibration may result in an incorrect reading, exposing the user to dangerous levels of carbon monoxide. Exposure to carbon monoxide can lead to unconsciousness and death.

Warning

This Analyzer must always be checked against a calibration gas and used with gases regulated and supplied at atmospheric pressure (0 psi). Use of gases at higher pressures may result in incorrect readings and may damage the Analyzer. Incorrect readings may expose the user to high levels of carbon monoxide resulting in personal injury or death.

Warning

Checking Calibration or use of the Analyzer with a low battery may result in inaccurate readings. Inaccurate gas analysis can lead to serious personal injury or death.

Notice

If the Analyzer has been subjected to a recent change in ambient temperature, allow it to stabilize for one hour before checking calibration.

Verify calibration on a weekly basis. Breathing gas applications require the use of a certified CO calibration gas with a 10 ppm concentration and flow rate of 1.0-5.0 L/min. The equipment to produce this flow is available from Nuair. See Spares and Accessories section.

To assure the greatest accuracy for other applications, use the calibration gas concentration closest to the expected concentration in the gas being measured.

11.6 Pro CO Operation

Prior to each Analyzer use:

- 1) Turn unit on (hold on/off for 3 sec) and monitor Display for low battery warning. Replace battery immediately if warning appears. Once fully cycled the screen should read "000"



- 2) Cycle through the current settings of the analyzer.
 - a. Hold down the “Prog” button for 2 seconds then use the “On/Off” button to cycle through the 1st Alarm Value, 2nd Alarm Value, Full Scale Value, Conversion Value of the Sensor, and Gain Factor.
 - b. Adjust Alarm values at this time if needed see “12.9. Pro CO Alarm Settings”.
- 3) Check Calibration of Analyzer using “Calibrated Test Gas”

Tip: You can check the battery life and current temperature by holding Adjust button for 3 seconds. The display will alternate from battery life to current temperature (Celsius) twice before returning the home screen.



Warning

Do not test cylinders suspected of containing carbon monoxide in a confined space that does not have good ventilation. Exposure to carbon monoxide can lead to unconsciousness and death.

Warning

Gas, even under moderate pressures, can cause extreme bodily harm. Never allow any gas stream to be directed at any part of your body.

Warning

Never expose the sensor to pressures above atmospheric pressure (0 psi) or you may cause damage to the sensor and/or receive false readings. Damaged Sensors will not provide accurate gas analysis. Inaccurate gas analysis can lead to serious personal injury or death.

Warning

It is very important that the calibration take place at atmospheric pressure (1 bar) and roughly 68° F (20° C) with the surrounding air being clean of CO. Calibration performed in air with CO such as aboard a moving boat with diesel exhaust or construction site with diesel engines operating will affect the calibration. On a moving boat air flow can trap the engine exhaust in the cabin or open deck area creating a high CO environment that will affect calibration.

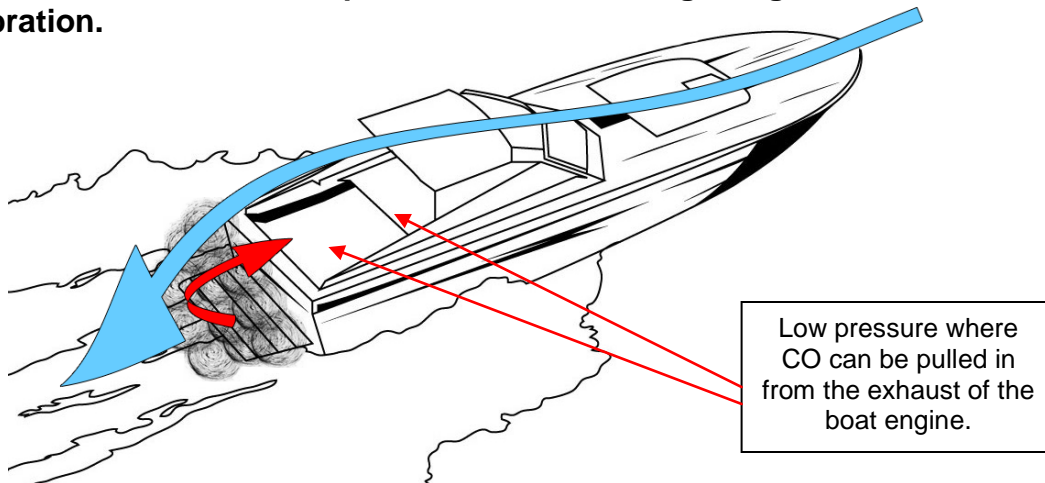

The Pro CO can be used to analyze a regulated gas sample flow, the contents of a gas cylinder, or the flow from a regulator:

- If analyzing a gas flow, the Sample Flow Method is the preferred method. The flow rate must equal 1.0-5.0 L/min at atmospheric pressure (1 bar). To produce this flow, a Flow Restrictor and Regulator may be required. Contact Nuair if you need assistance.

11.7 Pro CO Sample Flow Method of Checking Calibration

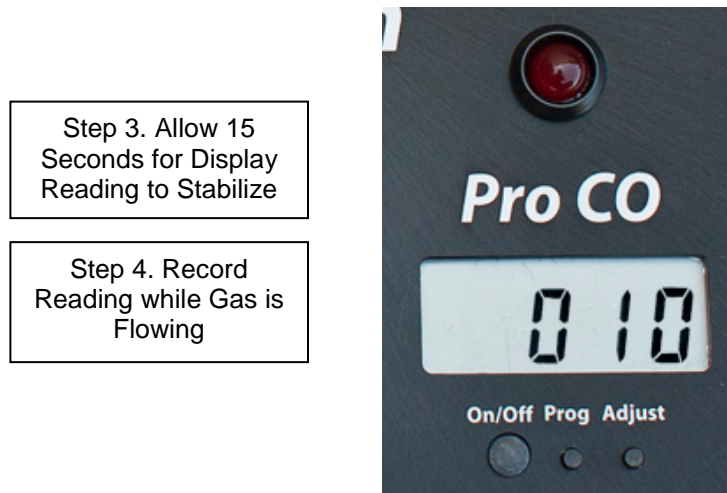

Nuair offers CO gas testing kits see addendum for more information.
Testing Gas must not contain Helium for calibration to succeed.

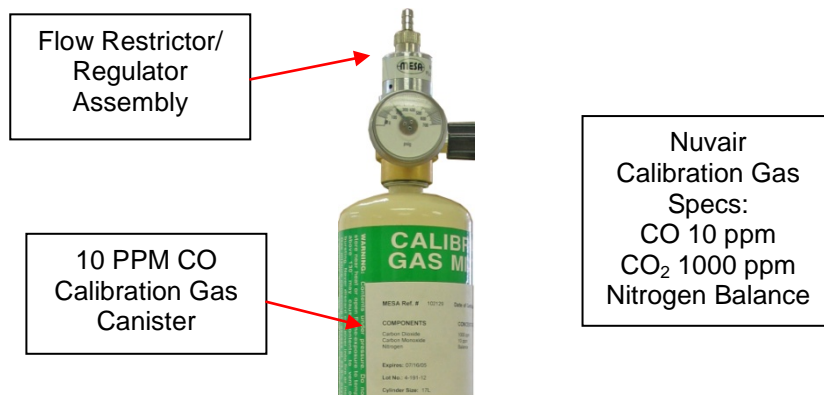

11.8 Pro CO Programming Procedures

Keep the “Pro” button pressed for more than two seconds and then release the button. “Pr” should display for two seconds and then the display will change to AL 1 and alternate with the 3 digit set value.

It is possible to program:

- **AL 1** First alarm point expressed in ppm of Carbon Monoxide concentration
- **AL 2** Second alarm point expressed in ppm of Carbon Monoxide concentration
- **FSC** Value expressed in ppm of Carbon Monoxide concentration corresponding to the current output full scale value (20mA). 4mA always correspond to zero ppm CO concentration.
- **nA** Conversion value of Carbon Monoxide sensor
- **Fct** Gain factor

At the end of the programming procedure the display will show “End” and the instrument will display the Carbon Monoxide content in the gas mix or “000” if not attached to a CO gas mix.

Below are the actual screen views of each of the modes.



Program



First Alarm



Second Alarm



Full Scale Value



Conversion Value of Sensor



Gain Factor

11.9 Pro CO Alarm Setting (AL 1 & AI 2)

- 1.) Press the “Prog” button for more than two seconds and then release the button.
On the display will appear “Pr” for two seconds, then “AL1” will appear and be ready for changing the value of the first alarm point. After a second the display will show the value of “AL1” CO ppm current setting.
- 2.) The blinking digit shows the cursor position.
- 3.) Press the “Prog” button to increase the value (from 0 to 9)
- 4.) Press the “Adjust” button to move the cursor to the next digit, the “Adjust” button will be used to cycle through the rest of the digits.
- 5.) To complete your entry and save the CO ppm value, press the “On/Off” button. You will then automatically jump to “AL 2” programming view.
- 6.) Repeat steps 3 through 5 to modify and save the “AL 2” CO ppm desired value.
- 7.) Once programming of “AL 2” is complete you will be in the “FSC” Value Screen and ready for programming this value. To jump to the end continue to press the “On/Off” button until the end screen appears.

11.10 Full Scale Value Setting (FSC)

Once the alarms have been set the Pro CO Analyzer goes to “FSC” view so that you can change the analog full scale value. It is not necessary to modify this value which is factory set at 300. However if installing a new sensor the value on the sensor can be entered into the “Fsc” setting and must be entered into the “Fct” setting. This is the Carbon Monoxide concentration corresponding to 20 mA on the analog output. 4mA is the value at 0 ppm of Carbon Monoxide. This value can be changed in the same manner as the Alarm settings:

- 1.) Press the “Prog” button for more than two seconds and then release the button.
On the display will appear “Pr” for two seconds, then “AL 1” will appear. Press the On/Off button to cycle through the Alarm settings until you reach the “FSC” view. The “FSC” screen and a 3 digit value will alternate for a few seconds and the Pro CO Analyzer will be ready for adjusting the “FSC” Value.
- 2.) The blinking digit shows the cursor position.
- 3.) Press the “Prog” button to increase the value (from 0 to 9)
- 4.) Press the “Adjust” button to move the cursor to the next digit, the “Adjust” button will be used to cycle through the rest of the digits.
- 5.) To complete your entry and save the FSC value, press the “On/Off” button. You will then automatically jump to “nA” programming view. To continue pass this to the end press the On/Off button until the “End” screen appears.

11.11 Conversion Value of Carbon Monoxide Sensor (nA)

After the “FSC” is set the Pro CO Analyzer goes to “nA”, this is the conversion value of the Carbon Monoxide sensor in nano Ampere. It is not necessary to modify this value except when a new sensor is installed. The new sensor is provided with the new value to be set on this screen. The display alternates between “nA” and the value of the full scale. The blinking digit shows the current cursor position.

- 1.) Press the “Prog” button for more than two seconds and then release the button.
On the display will appear “Pr” for two seconds, then “AL 1” will appear. Use the On/Off button to cycle through the various settings until you reach the nA” screen. The 3 digit value will alternate with the “nA” screen for a few seconds and the Pro CO Analyzer will be ready for adjusting the “nA” Value.
- 2.) The blinking digit shows the cursor position.

- 3.) Press the “Prog” button to increase the value (from 0 to 9)
- 4.) Press the “Adjust” button to move the cursor to the next digit, the “Adjust” button will be used to cycle through the rest of the digits.
- 5.) To complete your entry and save the Na value, press the “On/Off” button. You will then automatically jump to “Fct” programming view. To continue pass this to the end press the On/Off button until the “End” screen appears.
- 6.) ***This procedure is used ONLY when a new sensor has been ordered from Nuvaair and is ready to be installed.***

Warning

The conversion value of the Carbon Monoxide sensor is set in factory and must be changed only when the CO sensor is replaced. The new sensor will come from the factory with a label showing the new “nA” value to be programmed. A wrong value of this parameter will give a wrong reading of CO concentration. If it is modified the conversion value of the Carbon Monoxide sensor, the instrument will be no more accurate. All the analysis concentration shown on the display will be wrong. Do not modify this value. It is necessary to modify this value only at the installation of a new sensor. Wrong Carbon Monoxide analysis may lead to death.

11.12 Gain Factor (Fct)

After the “nA” the instrument goes to “Fct”, that is the conversion value of gain factor. It is not necessary to modify this value except when a new sensor is installed. The new sensor is provided with the new value to be set on this screen. The value is referred to as the “Fsc” number on the sensor. The display alternates between “Fct” and the conversion value of the gain factor.

The blinking digit shows the current cursor position.

- 1.) Press the “Prog” button for more than two seconds and then release the button. On the display will appear “Pr” for two seconds, then “AL 1” will appear. Use the On/Off button to cycle through the various settings until you reach the “Fct” screen. The 3 digit value will alternate with the “Fct” screen for a few seconds and the Pro CO Analyzer will be ready for adjusting the “Fct” Value.
- 2.) The blinking digit shows the cursor position.
- 3.) Press the “Prog” button to increase the value (from 0 to 9)
- 4.) Press the “Adjust” button to move the cursor to the next digit, the “Adjust” button will be used to cycle through the rest of the digits.
- 5.) To complete your entry and save the Gain Factor value, press the “On/Off” button. You will then automatically jump to the “End” and return to the current gas reading.
- 6.) ***This procedure is used ONLY when a new sensor has been ordered from Nuvaair and is ready to be installed.***

Warning

Then gain factor is set in factory and must be changed only when the CO sensor is replaced. The new sensor will come from the factory with a label showing the new ‘Fct’ value to be programmed. A wrong value of this parameter will give a wrong reading of CO concentration. If it is modified the gain factor instrument will be no more accurate. All the analysis concentration shown on the display will be wrong. Do not modify this value. It is necessary to modify this value only at the installation of a new sensor. Wrong Carbon Monoxide analysis may lead to death.

11.13 Pro CO Threshold Alarms

Should the Carbon Monoxide reading go over the threshold alarms (AL1 or AL2) the instrument will go into alarm mode and will activate the (optional) relays output (open collector max 100mA) and the internal buzzer. The display will show the trespassed alarm and the actual measured value. To stop the audible alarm, press any key. In this event the Pro Co Analyzer will remain in alarm mode until the analyzed value goes below the alarm. The relay output typically is used to shut down the compressor. Nuvair can supply the necessary components to adapt your compressor to the relay or provide them at the time of install on a new compressor.

11.14 Powering Off the Pro CO

At the home or gas reading screen, hold down the On/Off button for a couple of seconds. The Analyzer will display "OFF" and then go blank.



11.15 Pro CO Factory Reset

In case it is necessary to reset the Pro CO Analyzer to the factory settings, power on the Analyzer pressing at the same time for more than one second the "On/Off" and "Adjust" buttons. On the display will appear "res" and the instrument will go to the reading page.

You will need to open the Pro CO analyzer and get the Values from the sensor for inputting into the PRO CO analyzer before using.

⚠ Warning

In case of reset, the instrument will delete all the alarms settings, the full scale value, any new conversion value of Carbon Monoxide sensor and of the gain factory. Before using again the instrument, it may be necessary to program again the alarm values, the full scale value, and the conversion value of Carbon Monoxide sensor and gain factor if changed. All the analysis concentration shown on the display would be wrong. Wrong Carbon Monoxide analysis may lead to death.

11.16 Pro CO Sensor Replacement

You should take note of your "Fsc" Number and "nA" Number before installing a new sensor. The "Fsc" number is programmed into the Pro CO Analyzer at the "Fct" and "Fsc" setting. This information will be used to program the Pro CO analyzer after the sensor is installed.



⚠ Caution

Be sure to dispose of spent, leaking, or damaged Sensors properly, according to local regulations.

⚠ Danger

Do not swallow (ingest) either the electrolyte from the Sensor or the Sensor itself. The Potassium hydroxide chemical contained in the Sensor will cause severe injury or death. If electrolyte or the Sensor is swallowed, seek medical attention immediately.



⚠ Warning

If after handling the Analyzer or Sensor, you find that your fingers or other parts of your body feel “slippery” or the skin or eyes sting, immediately flush affected area with clean, fresh water for at least 15 minutes. The stinging or slippery sensation is an indication of a leaking Sensor. The Potassium Hydroxide chemical contained in the Sensor can cause severe injury or death. Seek immediate medical attention if eye contact is made or skin stinging persists.

11.17 Handling Pro CO Sensors

Replacement Sensors are supplied in sealed bags. Normally Sensors do not present a health hazard. Before opening the bag, check that the electrolyte has not leaked. However, if electrolyte leakage has occurred, do not open bag. Dispose of Sensor properly or return for replacement. If electrolyte leakage occurs while the Sensor is in service, use rubber gloves and chemical splash goggles for handling. Rinse contaminated surfaces thoroughly with water.

Electrolyte First Aid Procedures

- Ingestion - Drink a large volume of fresh water. Do not induce vomiting. Get immediate medical attention.
- Eye Contact - Flush eyes with clean, fresh water for at least 15 minutes and get medical help immediately.
- Skin Contact - Flush the affected area with clean, fresh water for at least 15 minutes and removed contaminated clothing. If stinging persists get medical attention.

12.0 Spares and Accessories

12.1 Calibration Equipment

Calibration requires certified calibration gas to be free of any moisture and delivered at a specific flow rate and pressure.

Nuvair offers a calibration gas canister with a compatible flow restrictor and regulator assembly to regulate the gas for proper calibration.

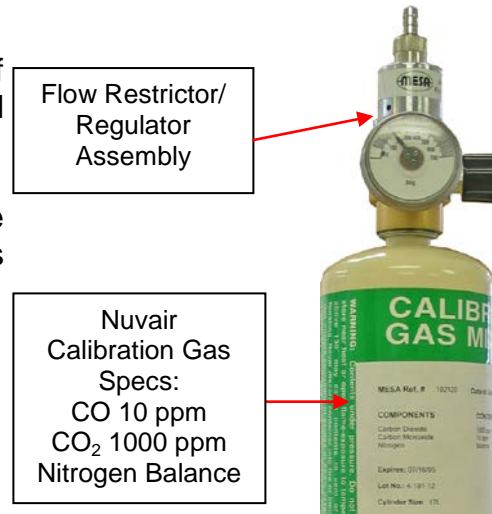

12.2 Replacement Sensors

12.2.1 O₂ Replacement Sensor SKU: 9507

12.2.2 CO Replacement Sensor SKU: 9501

12.3 Flow Restrictors and Regulators

A variety of Flow Restrictors and Pressure Regulators for the Sample Flow Method are available from Nuair, all calibrated to produce a flow rate of 1 – 5 L/min with a Regulator output of 100 – 160 psi.

Universal Flow Restrictors are used for most applications and are typically provided complete with Regulator.

When analyzing Scuba Cylinder gases, special Flow Restrictors can be used to obtain the sample gas directly from the BC inflator hose. A variety of BC Flow Restrictors are available to fit the different types of inflator hose QD fittings used.



HP Regulated Flow Restrictor
Part No. 9520-Int



HP Regulated Flow Restrictor
Part No. 9520-DIN

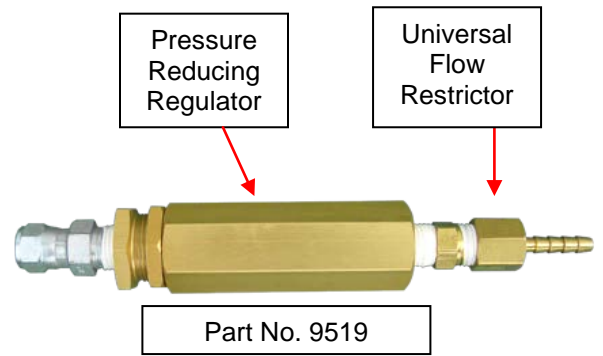

Part No. 9519



1/4" FNPT Flow Restrictor
Part - 9517



ScubaPro™ Flow Restrictor
Part - 9518-SCUBAPRO



Mares™ Flow Restrictor
Part - 9518-MARES



Standard Flow Restrictor
Part - 9518-STD

13.0 Troubleshooting

Battery symbol	Low Battery	Change the battery
No display	Switched off Bad connection Low Battery	Switch on Check display/ battery connection Change the battery
Reading erratic	Pressure on sensor Radio transmission O2/ CO Sensor old or faulty CO2 Sensor old or faulty Condensation on sensor.	Check flow Move unit away Change sensor Return to Dealer Dry in air
Display segments missing	Display faulty	Return to dealer

14.0 Relay Output Schematics

4-20mA Connections: The relay output uses a special “Mini Jack” plug that can be purchased separately from Nuvair. Insert the plug into the output jack. Connections diagram below for additional wiring.

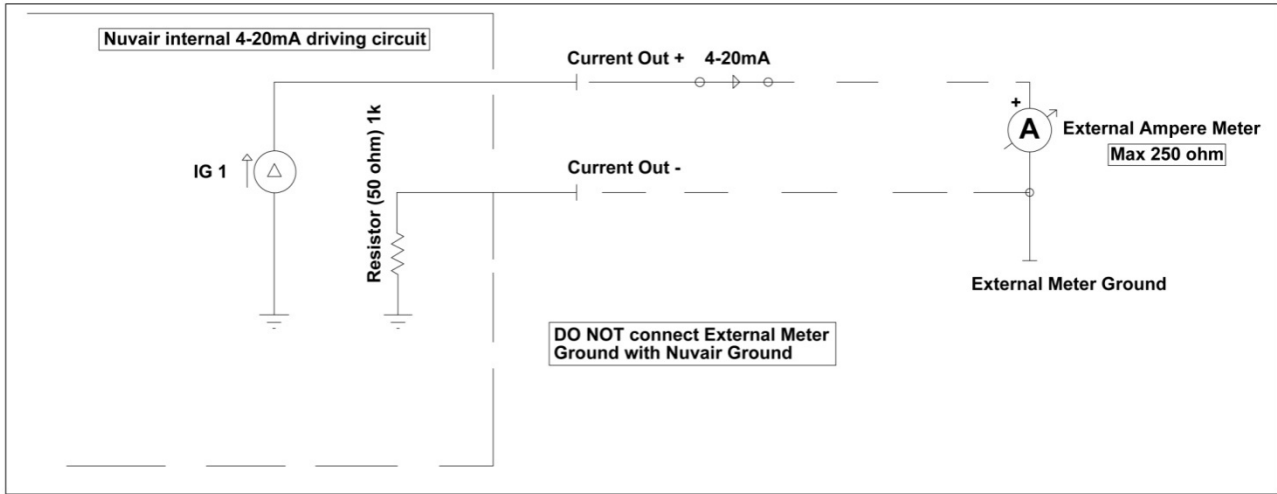

⚠ Warning

The plug should be connected or disconnected when the instrument is switched off, or the instrument will automatically switch off.

Open Collector Connections:

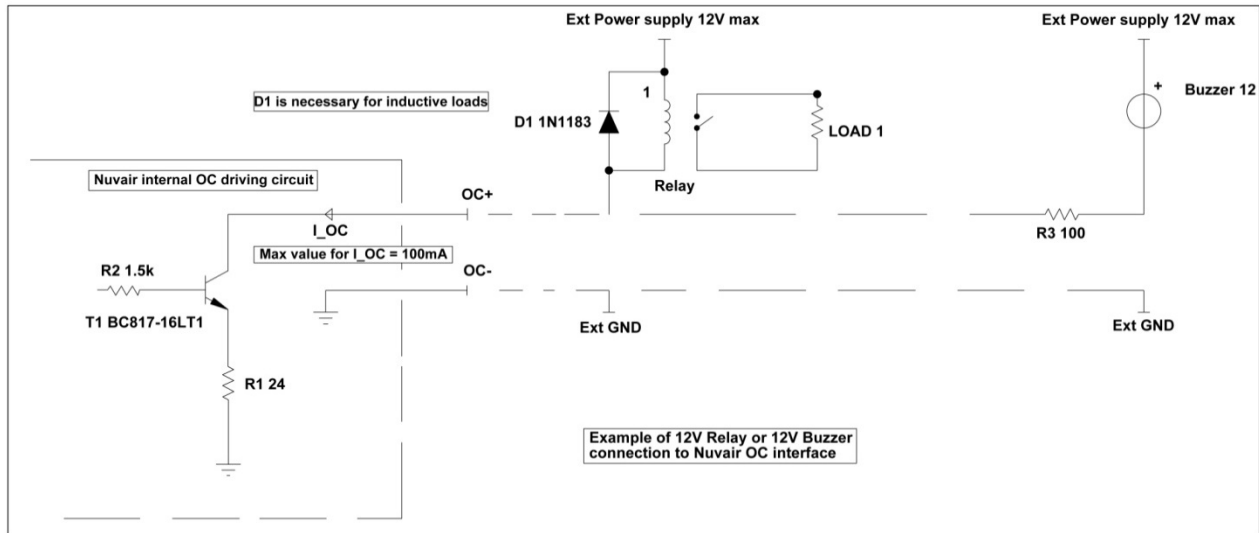

Nuvair Analyzer Trio Warranty

Nuvair extends a limited warranty, which warrants the Analyzer Trio to be free from defects in materials and workmanship under normal use and service for a limited period. The Analyzer Trio is warranted according to the terms as set forth below. This warranty is not transferable.

Nuvair will, at its discretion and according to the terms as set forth within, replace or repair any materials which fail under normal use and service and do not exhibit any signs of improper maintenance, misuse, accident, alteration, weather damage, tampering, or use for any other than the intended purpose. Determination of failure is the responsibility of Nuvair, which will work together with the customer to adequately address warranty issues. When any materials are repaired or replaced during the warranty period, they are warranted only for the remainder of the original warranty period. This warranty shall be void and NUVAIR shall have no responsibility to repair or replace damaged materials resulting directly or indirectly from the use of repair or replacement parts not approved by Nuvair.

Terms:

Nuvair warrants the Analyzer Trio to be free from defects in material and workmanship for a period of twelve (12) months from date of purchase with the exception of the Oxygen Sensor. The warranty covers parts and labor.

NUVAIR warrants the O₂ sensor to be free from defects in material and workmanship for a period of twenty-four (24) months from date of purchase. The warranty covers parts and labor and is prorated as follows:

- | | |
|------------------|---------------------|
| • 0 – 12 Months | Free Replacement |
| • 13 – 18 Months | 50% Off Replacement |
| • 19 – 24 Months | 25% Off Replacement |

A warranty registration card, supplied with system documentation, must be filled out and submitted to NUVAIR for the warranty to be registered. If the warranty registration card is not received within ten (10) days of purchase, the warranty will begin with the date of manufacture by Nuvair.

Maintenance Items:

Any materials which are consumed, or otherwise rendered not warrantable due to processes applied to them, are considered expendable and are not covered under the terms of this policy. This includes batteries.

Return Policy:

Application for warranty service can be made by contacting NUVAIR during regular business hours and requesting a Return Material Authorization number. Materials that are found to be defective must be shipped, freight pre-paid, to the Nuvair office in Oxnard, California. Upon inspection and determination of failure, Nuvair shall exercise its options under the terms of this policy. Warranty serviced materials will be returned to the customer via Nuvair's preferred shipping method, at Nuvair's expense. Any expedited return shipping arrangements to be made at customer's expense must be specified in advance.

Limitation of Warranty and Liability:

Repair, replacement or refund in the manner and within the time provided shall constitute Nuvair's sole liability and the Purchaser's exclusive remedy resulting from any nonconformity or defect. Nuvair shall not in any event be liable for any damages, whether based on contract, warranty, negligence, strict liability or otherwise, including without limitation any consequential, incidental or special damages, arising with respect to the equipment or its failure to operate, even if Nuvair has been advised of the possibility thereof. Nuvair makes no other warranty or representation of any kind, except that of title, and all other warranties, express or implied, including warranties of merchantability and fitness for a particular purpose, are hereby expressly disclaimed. No salesman or other representative of Nuvair has authority to make any warranties.



Nuvair
Phone: +1 805 815 4044
Fax: +1 805 486 0900
1600 Beacon Place
Oxnard, CA 93033
USA
info@nuvair.com
www.nuvair.com